

# 取扱説明書

## NTTFAX L-330 機器設定・管理編

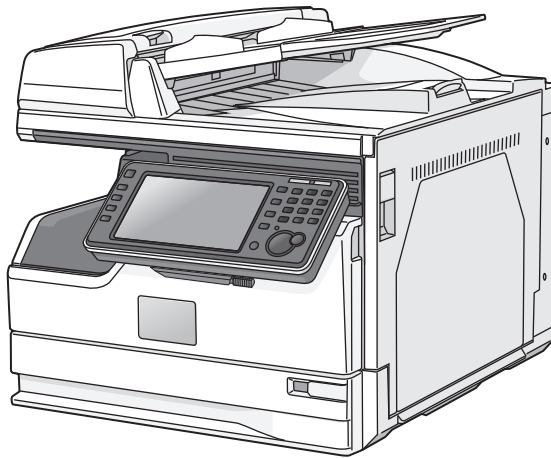

第 1 章 機器設定

1

第 2 章 管理設定

2

第 3 章 主な仕様

3

第 4 章 商標および著作権について

4

# 目次

本書の表示について.....iv	iv
安全に関する表示.....iv	iv
操作キーとボタンの表記.....iv	iv
原稿・用紙向きの表記.....iv	iv
画面について.....v	v
操作手順について.....v	v
ご使用前にお読みください.....vi	vi
機器の設置場所について.....vi	vi
日常のメンテナンスについて.....vii	vii
換気について.....vii	vii
消耗品の取り扱いについて.....viii	viii

## 第1章 機器設定

各種登録一覧.....1-2	1-2
優先応用機能を変更する.....1-4	1-4
ジョブメモリーを使用する.....1-6	1-6
ジョブメモリーを登録する・変更する.....1-6	1-6
ジョブメモリーを削除する.....1-8	1-8
ジョブメモリーリストをプリントする.....1-8	1-8
ジョブメモリーを実行する.....1-9	1-9
初期値を設定する.....1-10	1-10
初期値設定一覧.....1-11	1-11
節電モードを設定する.....1-14	1-14
用紙に関する設定をする.....1-19	1-19
プリント時に使用するカセットを指定する.....1-19	1-19
用紙/仕分け設定一覧.....1-21	1-21
リストをプリントする.....1-24	1-24
プリントのしかた.....1-24	1-24
リスト一覧.....1-25	1-25
機器情報を確認する.....1-27	1-27
ログインする/ログアウトする.....1-28	1-28
ログインする.....1-28	1-28
ログアウトする.....1-29	1-29
ICカードでログインする.....1-29	1-29
個人設定を使用する.....1-30	1-30
個人設定をする.....1-30	1-30
個人設定一覧.....1-31	1-31
個人画面・共有画面を切り替える.....1-32	1-32
文字を入力する.....1-33	1-33
文字入力画面について.....1-33	1-33
文字入力について.....1-34	1-34
漢字・ひらがなを入力する.....1-35	1-35
カタカナを入力する.....1-37	1-37
英数字を入力する.....1-38	1-38

記号を入力する .....	1-39
数字を入力する .....	1-40
空白（スペース）を入力する .....	1-40
ドメイン名を入力する .....	1-41
文字を削除する・挿入する .....	1-42

## 第 2 章 管理設定

---

機器管理設定一覧 .....	2-2
セキュリティコードを設定する .....	2-4
管理者パスワードを設定する .....	2-4
プロテクトコードを設定する .....	2-6
設定や操作を制限する（機能プロテクト設定） .....	2-8
機能プロテクトを設定する .....	2-9
機能プロテクトを使う .....	2-11
モード禁止設定をする .....	2-12
ユーザー使用状況を管理する .....	2-13
通貨単位を設定する .....	2-13
料金を設定する .....	2-15
ユーザー使用状況管理リストをプリントする .....	2-16
集計データを消去する .....	2-17
ネットワーク設定をする .....	2-18
TCP / IP 設定をする .....	2-19
LDAP サーバーを登録する .....	2-21
LDAP サーバーを削除する .....	2-25
LDAP 設定リストをプリントする .....	2-25
アーカイブ設定をする .....	2-26
ユーザー認証方法を設定する .....	2-30
機器設定をコピーする .....	2-31
USB メモリーにエクスポートする .....	2-31
USB メモリーから機器にインポートする .....	2-34
自動ログアウト時間を設定する .....	2-37
IC カード認証を設定する .....	2-38
IC カード認証を有効にする .....	2-38
認証方法を設定する .....	2-39
IC カード情報を登録する .....	2-40
セキュリティプリントのオートリリース機能を設定する .....	2-42

## 第 3 章 主な仕様

---

主な仕様 .....	3-2
主な仕様 .....	3-2
外形寸法 .....	3-10

## 第 4 章 商標および著作権について

---





商標および著作権などについて .....	4-2
登録商標および商標について .....	4-2
オープンソースソフトウェアに対応するソースコードの頒布について .....	4-2
オープンソースライセンスについて .....	4-2



# 本書の表示について

## 安全に関する表示

本書では、安全にお使いいただくために守っていただきたい事項や操作する上での重要情報に、以下のマークをつけています。

 <b>警告</b>	取り扱いを誤った場合に、死亡または重傷を負う可能性のある警告事項が書かれています。 安全に使用していただくために、必ずこの警告事項をお守りください。
 <b>注意</b>	取り扱いを誤った場合に、傷害を負う可能性または物的損害が発生する恐れがある注意事項が書かれています。安全に使用していただくために、必ずこの注意事項をお守りください。
 <b>お願い</b>	誤った操作によるトラブルを防ぐために、必ず守っていただきたい重要事項や制限事項が書かれています。
 <b>補足</b>	操作の参考情報や補足説明が書かれています。

## 操作キーとボタンの表記

- 〈 〉 操作パネル上のキー  
(例：スタートキー → 〈スタート〉)
- [ ] 液晶ディスプレイ上のボタンやコンピューター画面上のボタンなど  
(例：画質ボタン → [画質])

## 原稿・用紙向き表記

 記号：用紙を機械正面から見て縦にセットすることを表します。

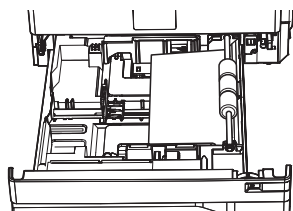

 記号：原稿を機械正面から見て縦にセットすることを表します。

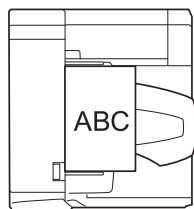

## 画面について

本書では、特に断りが無い限りオプションの増設給紙カセットを装着したときの画面を使用しています。オプションの装着によっては、画面が異なる場合があります。

## 操作手順について

操作中の説明では、[△]、[▽] など次の画面を表示する手順を省いています。オプションの装着によっては、記載されたメニューが見当たらないことがあります。  
たとえば、以下のように手順を説明しています。

- 1 [機器設定] タブ、[機器管理] の順に押します。
- 2 管理者パスワードを設定している場合は、管理者パスワードを入力し、[確定] を押します。  
管理者パスワードを設定していない場合は、そのまま次の手順に進みます。
- 3 [自動ログアウト時間] を押します。

実際には、[△]、[▽] を押して、次の画面にメニューがあるか確認してください。

- 1 [機器設定] タブ、[機器管理] の順に押します。
- 2 管理者パスワードを設定している場合は、管理者パスワードを入力し、[確定] を押します。  
管理者パスワードを設定していない場合は、そのまま次の手順に進みます。
- 3 [▽] を押します。

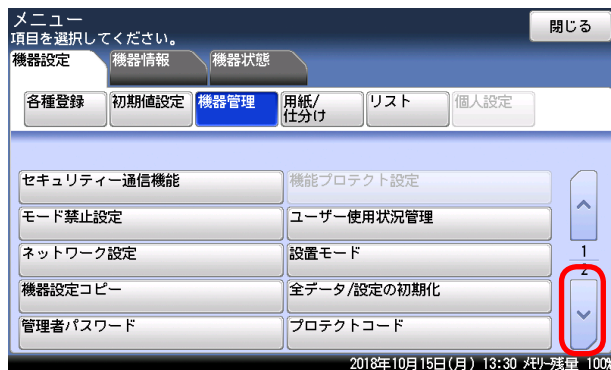

- 4 [自動ログアウト時間] を押します。

# ご使用前にお読みください

安全にご使用いただくために、本商品に同梱されている『安全にご使用いただくために』も必ずお読みください。

## 機器の設置場所について

### ⚠警告

オプションの IC カード認証装置は電波を発する端末です。装着した場合、航空機内や病院などの使用を禁止された場所では、電源を切ってください。電子機器や医療機器に影響を与え、事故の原因となります。

### ⚠注意

- 機器の左側面と背面にある通風孔を壁やほかの機器などから 10 cm 以上離してください。
- 製品の操作に十分なスペースを確保してください。
- 温度差の激しい場所に設置しないでください。  
温度： 10 ~ 32°C  
相対湿度： 10°C以上 30°C以下のとき 20 ~ 80%  
30°Cを超えて 32°C以下のとき 20 ~ 68%温度
- 屋外での設置や使用はしないでください。
- コンセントはできるだけ機器のそばにあるものを利用し、そのコンセントに容易に近づけるようにしてください。非常時に電源プラグを抜けなくなります。

(単位: mm)

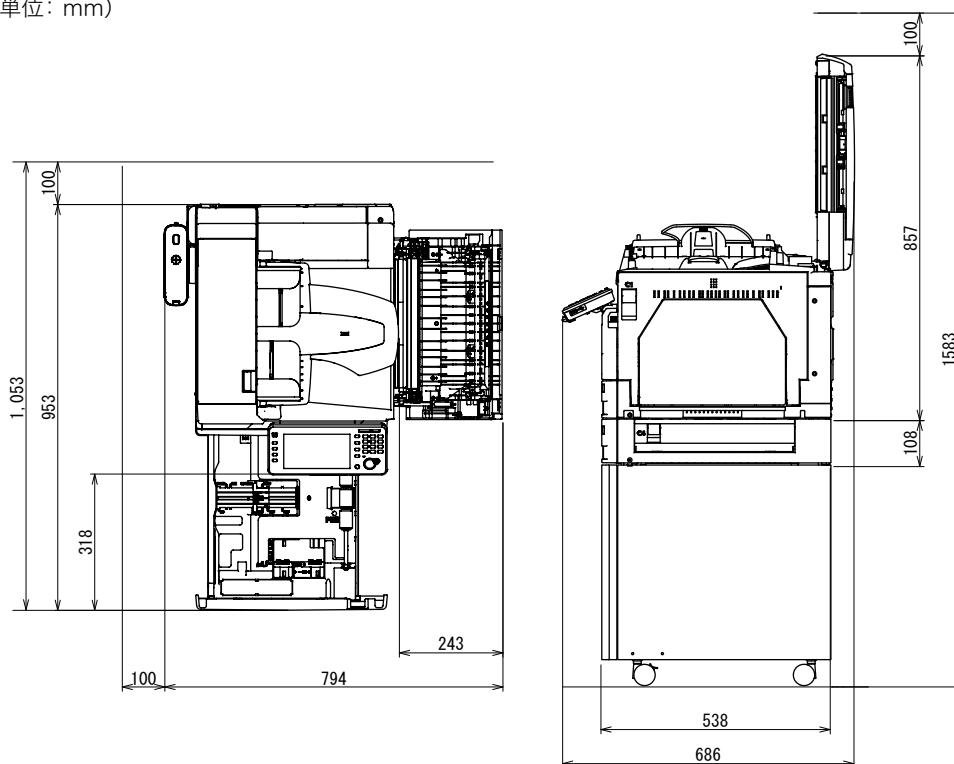

本体 + 増設給紙カセット + 専用台 + ハンドセット

## 日常のメンテナンスについて

### ⚠注意

- 機器内部の定着器周辺は動作時に高温になります。紙づまりの処理や内部を点検するときは、定着器周辺に触れないように注意してください。やけどをする恐れがあります。

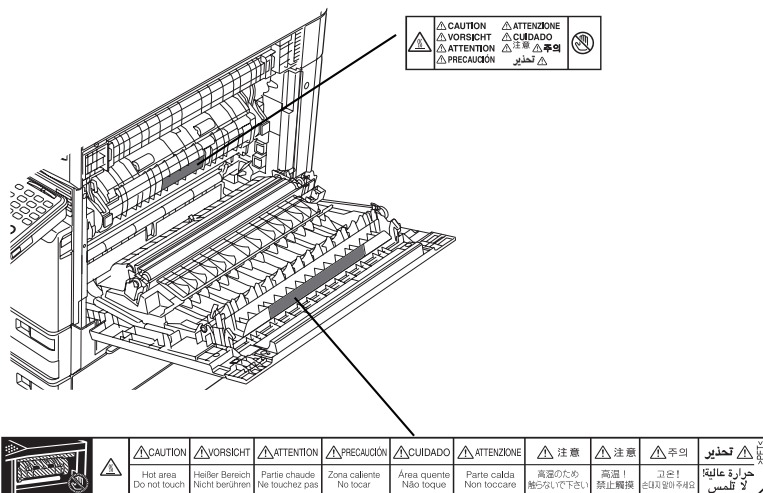

- 紙づまりの処理や、ドラムカートリッジ、トナーカートリッジまたは廃トナーボトルを交換するときは、トナーが目や口に入らないように注意してください。万一、トナーが目や口に入った場合は、直ちにきれいな水で洗い流し、医師の診察を受けてください。
- トナーで手や衣服を汚さないように注意してください。手や衣服が汚れた場合は、きれいな水で洗い流してください。温水で洗うとトナーが定着し汚れがとれなくなる場合があります。
- 取扱説明書に記載されている以外のことは行わないでください。

## 換気について

### ⚠注意

- 定期的に部屋の換気をしてください。
- 本商品は使用中にオゾンが発生します。オゾンの量は人体に影響を及ぼすほどの量ではありませんが、換気の悪い場所で長時間使用したり、大量のプリントをしたりするときは、部屋の換気をしてください。

# 消耗品の取り扱いについて

---

## ⚠警告

絶対に、トナーカートリッジや廃トナーボトルを火中に投げないでください。トナーに引火して、やけどや火災の原因になることがあります。

## ⚠注意

- トナーカートリッジを分解しないでください。トナーが漏れたときは、吸い込んだり直接皮膚につかないように注意してください。トナーが皮膚についた場合は、石けんを洗い流し、刺激が残る場合や吸い込んだ場合には直ちに医師に相談してください。
- トナーなどの消耗品は幼児の手が届かないところへ保管してください。もしトナーを飲んだ場合は、直ちに医師と相談してください。

## ❗お願い

- ドラムカートリッジやトナーカートリッジ、用紙を以下のような場所には保管しないでください。
  - ◆ 火気のある場所
  - ◆ 直射日光のあたる場所
  - ◆ 高温多湿な場所
  - ◆ 急激な温度変化のある場所
  - ◆ ほこりの多い場所
  - ◆ 自動車内での長時間放置
- ドラムカートリッジの感光体表面に直接手を触れたり、直射日光に当てたりしないでください。印字画質不良の原因になります。
- ドラムカートリッジやトナーカートリッジを逆さに向けたり、斜めに放置したりしないでください。印字画質不良の原因になります。
- ドラムカートリッジやトナーカートリッジを分解しないでください。
- ドラムカートリッジやトナーカートリッジに強い衝撃や振動を与えないでください。
- ドラムカートリッジやトナーカートリッジは使用する直前まで袋から出さないでください。

# 第 1 章

## 機器設定

---

各種登録一覧.....	1-2
優先応用機能を変更する.....	1-4
ジョブメモリーを使用する.....	1-6
ジョブメモリーを登録する・変更する.....	1-6
ジョブメモリーを削除する.....	1-8
ジョブメモリーリストをプリントする.....	1-8
ジョブメモリーを実行する.....	1-9
初期値を設定する.....	1-10
初期値設定一覧.....	1-11
節電モードを設定する.....	1-14
用紙に関する設定をする.....	1-19
プリント時に使用するカセットを指定する.....	1-19
用紙／仕分け設定一覧.....	1-21
リストをプリントする.....	1-24
プリントのしかた.....	1-24
リスト一覧.....	1-25
機器情報を確認する.....	1-27
ログインする／ログアウトする.....	1-28
ログインする.....	1-28
ログアウトする.....	1-29
IC カードでログインする.....	1-29
個人設定を使用する.....	1-30
個人設定をする.....	1-30
個人設定一覧.....	1-31
個人画面・共有画面を切り替える.....	1-32
文字を入力する.....	1-33
文字入力画面について.....	1-33
文字入力について.....	1-34
漢字・ひらがなを入力する.....	1-35
カタカナを入力する.....	1-37
英数字を入力する.....	1-38
記号を入力する.....	1-39
数字を入力する.....	1-40
空白（スペース）を入力する.....	1-40
ドメイン名を入力する.....	1-41
文字を削除する・挿入する.....	1-42

# 各種登録一覧

〈メニュー〉 → [機器設定] タブ → [各種登録] と押したときに設定できる項目の一覧です。宛先表やジョブメモリーの登録など、各機能で使用する便利な機能が登録できます。

機能	機能説明	参照ページ
宛先表	宛先の登録、変更、または削除ができます。	『スキャナー・ファクス編』第8章の「宛先を登録する」の「宛先を登録・変更する」
宛先グループ	宛先グループの登録、変更または削除ができます。	『スキャナー・ファクス編』第8章の「宛先を登録する」の「宛先グループを登録・変更する」
優先応用機能	よく使用する機能を優先応用機能に設定できます。	1-4
ジョブメモリー	ジョブメモリーの登録、変更または削除ができます。	1-6
お気に入り宛先 <sup>1)</sup>	スキャナー画面のお気に入り宛先タブに表示する宛先の登録、変更、または削除ができます。	『スキャナー・ファクス編』第8章の「宛先を登録する」の「お気に入り宛先を登録する」
フォルダーショートカット <sup>1)</sup>	共有フォルダーのパスをショートカットとして登録、変更、または削除ができます。	『スキャナー・ファクス編』第8章の「宛先を登録する」の「フォルダーショートカットを登録・変更する」
FTP ショートカット <sup>1)</sup>	FTP サーバーのパスをショートカットとして登録、変更、または削除ができます。	『スキャナー・ファクス編』第8章の「宛先を登録する」の「FTP サーバーショートカットを登録・変更する」
TWAIN ボックス	TWAIN ボックスの名前と暗証番号を登録、または変更できます。	『スキャナー・ファクス編』第1章の「TWAIN ボックスに蓄積する」の「TWAIN ボックスの設定を変更する」
自動配信	受信したファクスを配信する条件を登録できます。また、その条件の変更、削除ができます。	『スキャナー・ファクス編』第4章の「受信に関する設定」の「受信原稿を配信する（自動配信）」
ファイル名	読み取った画像データのファイル名を、あらかじめ登録できます。	『スキャナー・ファクス編』第8章の「その他の登録をする」の「ファイル名を登録・変更する」
文書分類名 <sup>1)</sup>	読み取った原稿をボックスに保存するときに設定できる文書分類名の登録や変更、削除ができます。	『スキャナー・ファクス編』第8章の「その他の登録をする」の「文書分類名を登録・変更する」
定型ドメイン名	文字入力画面に表示されるドメイン名を登録できます。	『スキャナー・ファクス編』第8章の「その他の登録をする」の「ドメイン名を登録・変更する」

機能	機能説明	参照ページ
Fコードボックス	Fコードボックスの登録、変更、削除、またはリストのプリントができます。	『スキャナー・ファクス編』第4章の「Fコード通信をする」の「Fコードボックスを登録する」
定型文 <sup>1</sup>	インターネットファクスやスキャン to E-mailの本文と件名をあらかじめ登録できます。	『スキャナー・ファクス編』第8章の「その他の登録をする」の「定型文を登録・変更する」
送信案内書文書登録 <sup>2</sup>	ファクス送信時に付ける簡単な文書を登録できます。	『スキャナー・ファクス編』第4章の「送信に関する設定」の「送付案内書を付ける (Information server を装着していないとき)」

\* 1 オプションの Information server が必要です。

\* 2 オプションの Information server が装着されているときは表示されません。



# 優先応用機能を変更する

各モードの応用機能を待機画面に6つまで表示できます。よく使う機能を、待機画面から使えるように設定できます。

コピー画面の例

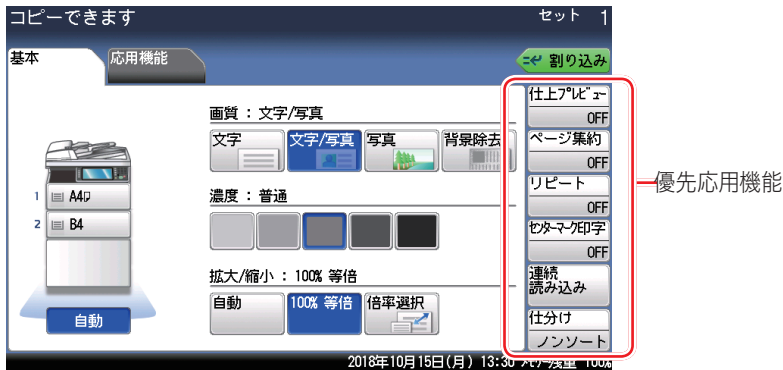

待機画面	割り当てられる機能
コピー画面	仕上がりプレビュー、ページ集約、仕分け、リポート、連続読み込み、センターマーク印字、ミックス原稿、三つ折りマーク印字、鏡像、ジョブメモリー1～6 <sup>*1</sup>
スキャナー画面	読み取りプレビュー、解像度、拡大/縮小 <sup>*2</sup> 、ファイル名 <sup>*3</sup> 、カラー/白黒、画質、濃度、連続読み込み、両面読み取り、分割送信、ファイル形式、TWAIN 原稿削除 <sup>*4</sup> 、済スタンプ、短縮送信 <sup>*5</sup> 、メールアドレス <sup>*5</sup> 、メール編集 <sup>*5</sup> 、メール履歴 <sup>*5</sup> 、文書分類 <sup>*5</sup> 、コメント <sup>*5</sup> 、スキャンパス通知 <sup>*5</sup> 、TWAIN 原稿 <sup>*5</sup> 、保存期間 <sup>*5</sup> 、グループ送信 <sup>*5</sup> 、ジョブメモリー1～6 <sup>*1</sup>
ファクス画面	読み取りプレビュー、画質、濃度、リダイヤル、オンフック、短縮送信、送付案内書、時刻指定、自動配信、自動受信、メモリー送信、発信元名、済スタンプ、送信確認証、連続読み込み、セキュリティー受信、IDチェック、閉域送信、Fコードポーリング、ポーリング、ポーリング原稿、Fコード送信、Fコード原稿、メールアドレス <sup>*5</sup> 、メール編集 <sup>*5</sup> 、メール履歴 <sup>*5</sup> 、分割送信 <sup>*5</sup> 、ファイル形式 <sup>*5</sup> 、POP受信 <sup>*5</sup> 、回線選択 <sup>*6</sup> 、ジョブメモリー1～6 <sup>*1</sup> 、通信モード、グループ送信、受信プレビュー印字 <sup>*4</sup>

- \* 1 ジョブメモリーは、ジョブの登録番号で選択してください。
- \* 2 Information server 非装着時の初期値です。
- \* 3 Information server 装着時の初期値です。
- \* 4 Information server 非装着時だけ表示されます。
- \* 5 オプションの Information server が必要です。
- \* 6 オプションの 2 回線キットが必要です。

## 補足

\_\_の付いている値が、工場出荷時の設定です。

- 1 <メニュー> を押します。
- 2 [機器設定] タブ、[各種登録] の順に押します。
- 3 [優先応用機能] を押します。

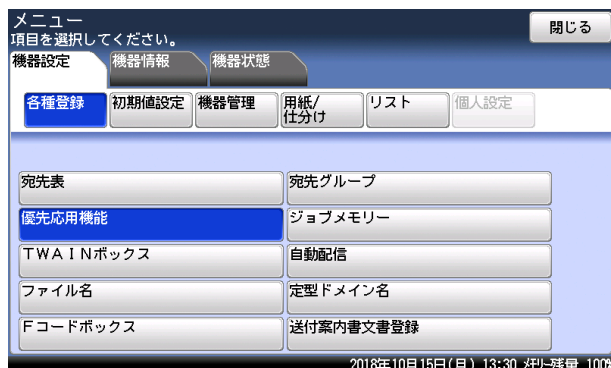

- 4 設定する待機画面を選択します。

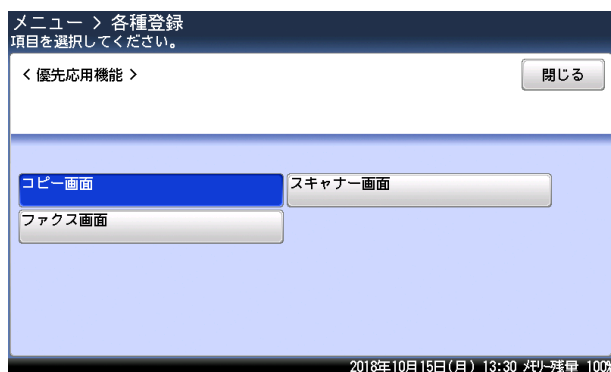

ここでは、例として [コピー画面] を選択します。

- 5 変更したい優先応用機能を選択します。

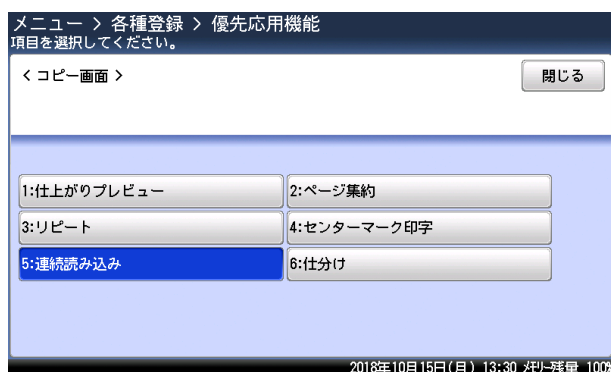

- 6 優先応用機能として表示したい機能を選択し、[確定] を押します。

# ジョブメモリーを使用する

よく使う設定をジョブメモリーに登録しておけば、設定のための操作の手間を省けます。

## 補足

- ジョブメモリーは6個まで登録できます。
- プリンター機能は登録できません。
- ジョブメモリーの登録中は、登録中のモードに該当するモードキーが点滅して、ジョブメモリーの登録中であることを知らせます。

## ジョブメモリーを登録する・変更する

ここではジョブメモリーの登録方法を説明します。変更の場合は、手順4で変更したいジョブメモリーを選択し、[変更]を押します。変更したい項目を選択して変更してください。

## 補足

コピー、スキャナー、ファクス待機画面の[応用機能]タブ→[ジョブメモリー]→[登録/変更]からも登録画面が表示できます。手順4から続けてください。

- 1 <メニュー> を押します。
- 2 [機器設定] タブ、[各種登録] の順に押します。
- 3 [ジョブメモリー] を押します。

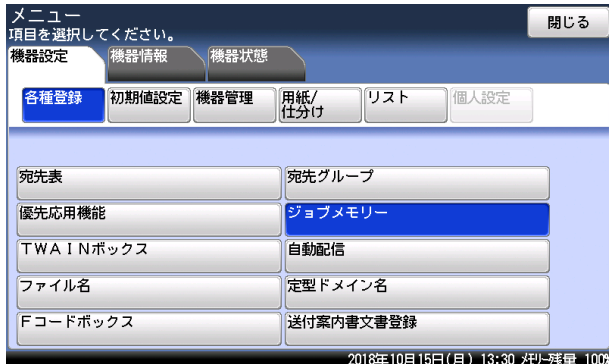

- 4 [登録] を押します。

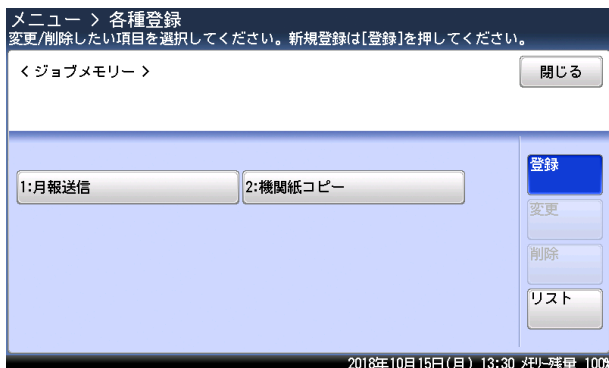

## 5 登録したいジョブの種別を選択します。

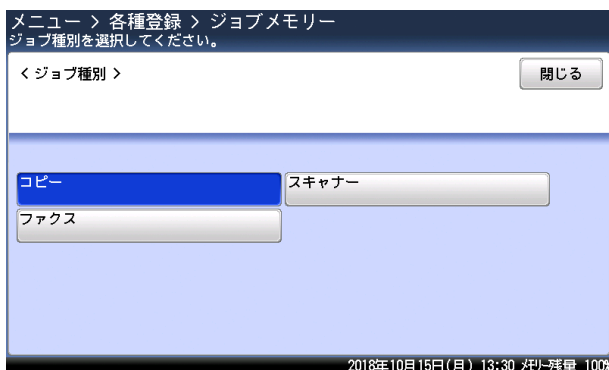

## 6 登録したい操作を行い、[確定] を押します。

ここで拡大／縮小コピーや濃度の調整など、ジョブメモリーを起動したときに呼び出したい設定を登録します。

## 7 ジョブ名を登録する場合は、[ジョブ名] を押します。

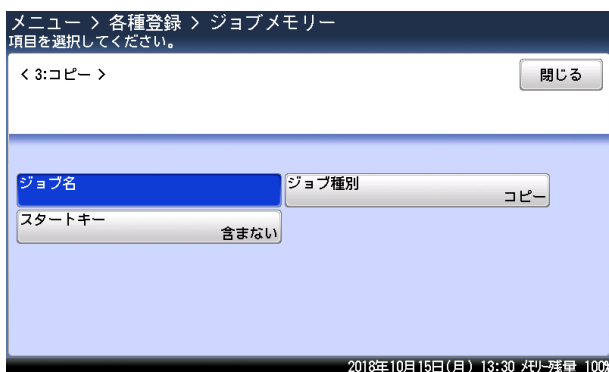

ジョブ名を登録しなかった場合は、ジョブの種別がジョブメモリーの一覧に表示されます。

## 8 ジョブ名を登録し、[確定] を押します。

- ・全角で 20 文字（半角で 40 文字）まで入力できます。
- ・文字入力のしかたは、「文字を入力する」(1-33 ページ) を参照してください。

## 9 [スタートキー] を押します。

## 10 ジョブメモリーにスタートキーを含む場合は [含む]、含まない場合は [含まない] を選択し、[確定] を押します。

- ・含まない： ジョブメモリーを実行するときに、設定を確認して手動でスタートさせたい場合を選択します。
- ・含む： ジョブメモリーを実行するときに、自動でジョブをスタートさせたい場合を選択します。

## 11 [閉じる] を押します。

## ジョブメモリーを削除する

---

### 補足

コピー、スキャナー、ファクス待機画面の [応用機能] タブ → [ジョブメモリー] → [登録 / 変更] から登録画面が表示できます。手順 4 から続けてください。

- 1 <メニュー> を押します。
- 2 [機器設定] タブ、[各種登録] の順に押します。
- 3 [ジョブメモリー] を押します。
- 4 削除したいジョブメモリーを選択し、[削除] を押します。
- 5 [はい] を押します。  
[いいえ] を押すと、手順 4 の画面に戻ります。

## ジョブメモリーリストをプリントする

---

登録したジョブメモリーの一覧をプリントできます。

### 補足

- コピー、スキャナー、ファクス待機画面の [応用機能] タブ → [ジョブメモリー] → [登録 / 変更] からジョブメモリーリストをプリントできます。手順 4 から続けてください。
- <メニュー> → [機器設定] タブ → [リスト] → [ジョブメモリーリスト] から、ジョブメモリーリストをプリントできます。手順 5 から続けてください

- 1 <メニュー> を押します。
- 2 [機器設定] タブ、[各種設定] を押します。
- 3 [ジョブメモリー] を押します。
- 4 [リスト] を押します。
- 5 [はい] を押します。
  - ・「ページ集約」を [ON] にすると、リスト 2 枚分を 1 枚の用紙に並べてプリントします。
  - ・パンチの目印になるセンターマークをプリントできます。センターマークを付けたい位置を選択します。

# ジョブメモリーを実行する

- 1 コピー、スキャナー、またはファクス待機画面で [応用機能] タブを押します。
- 2 [ジョブメモリー] を押します。
- 3 実行したいジョブメモリーを選択します。

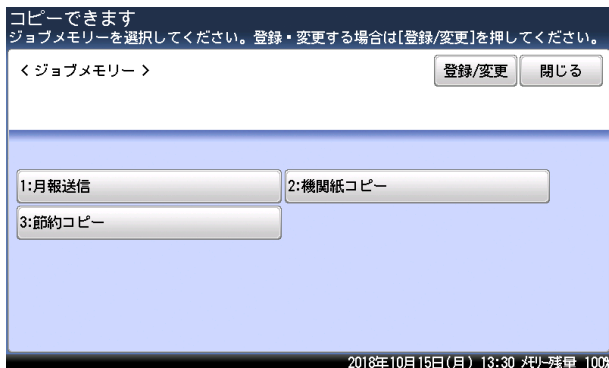

- ・ジョブメモリーに〈スタート〉まで登録されているときは、登録したジョブが始まります。
- ・ジョブメモリーに〈スタート〉が登録されていないときは、登録した内容が表示されます。
- ・[登録 / 変更] を押すと、ジョブメモリーの登録や変更 (→ 1-6 ページ)、削除 (→ 1-8 ページ)、リストのプリント (→ 1-8 ページ) ができます。

# 初期値を設定する

初期値とは、〈リセット〉を押したときに設定される値のことです。何も操作せずに一定時間放置したときも、初期値に戻ります。よく使う設定を初期値にしておくと、操作のたびに設定する手間が省けます。

- 1 〈メニュー〉を押します。
- 2 [機器設定] タブ、[初期値設定] の順に押します。

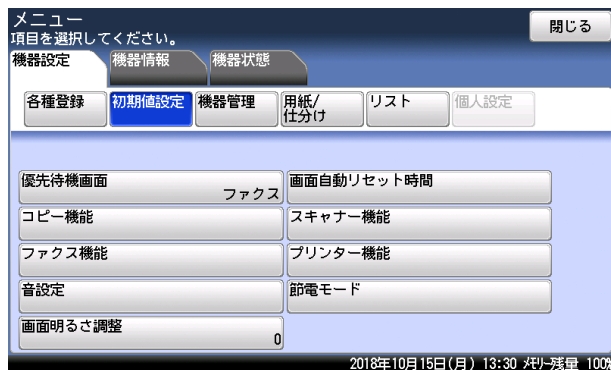

- 3 設定する項目を選択します。
- 4 初期値を選択し、[確定] を押します。

# 初期値設定一覧

機能	機能説明	設定値
優先待機画面	電源スイッチを ON にしたときや、画面自動リセット時間で設定した時間が経ったときに表示される待機画面を設定できます。	コピー スキャナー ファクス プリンター
画面自動リセット時間	各画面を待機画面に戻すまでの時間を設定できます。  <ul style="list-style-type: none"> <li>• コピー画面、スキャナー画面</li> <li>• ファクス画面</li> <li>• プリンター画面</li> </ul> リセット時間： 何も操作をしなかった場合、設定をリセット（初期値に戻す）し待機画面に戻るまでの時間。 読み取り終了後にリセット： ON に設定すると、原稿の読み取り終了後すぐに、設定をリセットします。 OFF に設定すると、リセット時間で設定した時間後にリセットされます。 読み取り終了後にログアウト： ON に設定すると、原稿の読み取り終了後すぐに、ログアウトします。	リセット時間 1 ～ 10 分： <u>3 分</u> 読み取り終了後にリセット <u>OFF</u> ON 読み取り終了後にログアウト <u>OFF</u> ON  リセット時間 1 ～ 10 分： <u>3 分</u> 読み取り終了後にログアウト <u>OFF</u> ON  リセット時間 1 ～ 10 分： <u>3 分</u>
コピー機能	コピー機能の初期値を設定できます。 詳細は、『コピー編』第 3 章の「初期値を設定する」を参照してください。	
スキャナー機能	スキャナー機能の初期値を設定できます。 詳細は、『スキャナー・ファクス編』第 8 章の「初期値を設定する」の「スキャナー機能の初期値を設定する」を参照してください。	
メール機能 <sup>1)</sup>	スキャン to メールやインターネットファクス、メール定型文の初期値を設定できます。 詳細は、『スキャナー・ファクス編』第 8 章の「初期値を設定する」の「電子メール送信の初期値を設定する」を参照してください。	
ファクス機能	ファクス機能の初期値を設定できます。 詳細は、『スキャナー・ファクス編』第 8 章の「初期値を設定する」の「ファクス機能の初期値を設定する」を参照してください。	



機能	機能説明	設定値
プリンター機能	プリンター機能の初期値を設定できます。 詳細は、『プリンター編』第2章の「プリンター機能に関する設定」を参照してください。	
音設定	各種音の設定ができます。	
操作確認音	操作ボタンを押したときに、鳴らす音色と音量が設定できます。 以下の画面で、それぞれ音色と音量が設定できます。 コピー画面 スキャナー画面 ファクス画面 プリンター画面	音色 OFF 低音 中音 高音 音量 1～7段階： <u>4</u>
動作完了音	コピーやファクス、プリント動作の完了を音で知らせます。以下の場合に、鳴らす音色と音量が設定できます。 コピー完了：コピーが完了したとき スキャン完了：スキャンが完了したとき。 ファクス送信完了： ファクスやインターネットファクス送信が完了したとき ファクス受信完了： ファクスやインターネットファクス受信が完了したとき ファクス受信印字完了： 受信した文書のプリントが完了したとき PCプリント完了：PCプリントが完了したとき リストプリント完了： リストのプリントが完了したとき	音色 OFF タイプ1 タイプ2 タイプ3 音量 1～7段階： <u>4</u>

機能	機能説明	設定値
注意音	紙づまりのお知らせやメモリーオーバーなどのエラーをブザー音で知らせます。以下の場合に、鳴らす音色と音量が設定できます。 紙づまりのお知らせ： 用紙づまりが発生したとき 用紙切れのお知らせ： 用紙が無くなったとき トナー交換のお知らせ： トナーの交換が必要なとき PC プリントエラー： PC プリント時にエラーが起きたとき ファクス通信エラー： ファクス・インターネットファクス通信時にエラーが起きたとき メモリーオーバー： スキャン中にメモリーオーバーが起きたとき カバー閉め忘れ警告： いずれかのカバーが開いているとき 原稿づまり： 自動原稿送り装置に原稿がつまっているとき ドラム交換のお知らせ： ドラムの交換が必要なとき 点検エラー：点検を受けてほしいとき 受信プリント待ち警告： 受信したファクスをプリントする用紙が無くなったとき その他： 上記のお知らせやエラーに含まれない項目の注意音を一括して設定します。	音色 OFF ON  音量 1～7段階：4
呼び出し音	ハンドセット（オプション）が無くても、ファクスの着信時に呼出ベル音が鳴るように設定できます。	OFF ON  音量 1～7段階：4
節電モード	設定の詳細については、「 <a href="#">節電モードを設定する</a> 」(1-14 ページ) を参照してください。	
画面明るさ調整	タッチパネルの明るさを調整します。	-3～+3：0

\* 1 オプションの Information server が必要です。

#### 補足

\_\_の付いている値が、工場出荷時の設定です。

# 節電モードを設定する

## □ 節電モードを設定する

機器は、一定時間以上使っていないと自動的に節電モードに入り、電力を節約できる節電機能があります。設定できる項目は以下のとおりです。

項目	内容
節電モードの設定	節電モードの設定を変更できます。出荷時の設定は、モード2です。 モード1：節電モードから待機画面に復帰するまでの時間が、モード2より短くなります。ただし、節電中の消費電力がモード2よりも高くなります。また、最小電力モードの設定はできません。 モード2：モード1よりも節電中の消費電力を低くできます。ただし、待機画面に復帰するまでの時間は、モード1より長くなります。 節電モードは〈節電〉を押すと解除できますが、モード1を設定したときはより多くの方法で節電モードを解除できます。(→ 1-17 ページ)
節電モードへの移行時間	節電モードへ移行するまでの時間 (1 ~ 480 分) を設定できます。(出荷時設定：1 分) 節電モードを働かないように設定することはできません。
節電モード時刻指定	
開始時刻	ON に設定すると、節電モードを自動的に開始する時刻を設定できます。
解除時刻	ON に設定すると、節電モードを自動的に解除する時刻を設定できます。
解除曜日	節電モードを自動的に解除する曜日を設定できます。 たとえば、解除曜日に月曜日から金曜日までを指定すると、土曜日と日曜日は解除時刻になっても節電モードが解除されません。 解除曜日の設定は、節電モードの解除時刻を設定したときのみ可能です。
最小電力モード <sup>*1</sup>	最小電力モードを ON に設定すると、指定した開始時刻と解除時刻の間の消費電力が通常の節電モードよりも抑えられますが、最小電力モード中はファクス受信以外の操作ができません。最小電力モード中にプリントジョブを実行する場合は、〈節電〉を押して最小電力モードを解除してください。 最小電力モードの設定は、モード2で節電モードの開始時刻と解除時刻を設定したときのみ可能です。

\* 1 Information server が装着されているときは、表示されません。

- 1 〈メニュー〉を押します。
- 2 [機器設定] タブ、[初期値設定] の順に押します。

### 3 [節電モード] を押します。

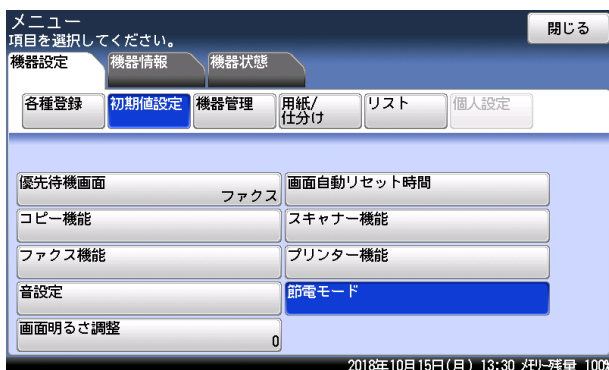

### 4 [設定] を押します。

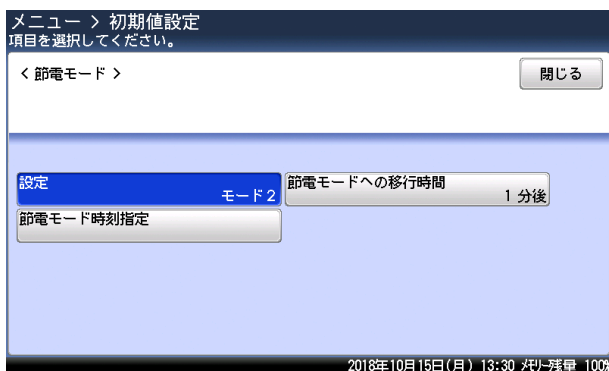

### 5 [モード1] または [モード2] を選択し、[確定] を押します。

### 6 [節電モードへの移行時間] を押します。

### 7 節電モードへの移行時間を設定し、[確定] を押します。

[+] と [-] や、テンキーを使っても設定できます。

### 8 [節電モード時刻指定] を押します。

### 9 [開始時刻] を押します。

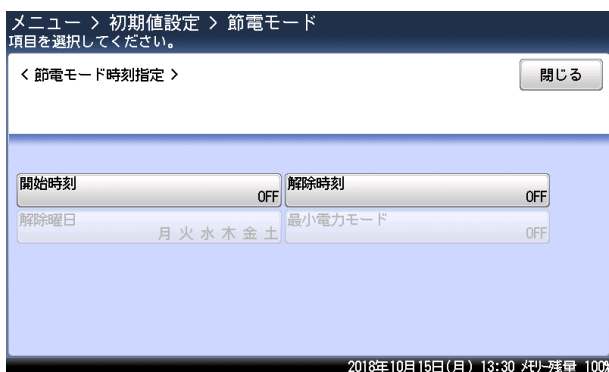

開始時刻を設定しないときは、手順 12 進みます。

## 10 [ON] を押します。

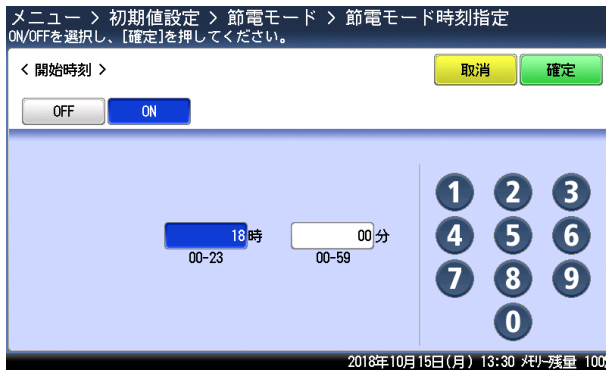

[OFF] を選択すると、節電モード開始時刻設定が OFF になります。

## 11 節電モードの開始時刻を設定し、[確定] を押します。

テンキーを使って設定します。

## 12 [解除時刻] を押します。

## 13 [ON] を押します。

[OFF] を選択すると、節電モード解除時刻設定が OFF になります。

## 14 節電モードの解除時刻を設定し、[確定] を押します。

テンキーを使って設定します。

## 15 [解除曜日] を押します。

## 16 節電モードを解除する曜日を選択し、[確定] を押します。

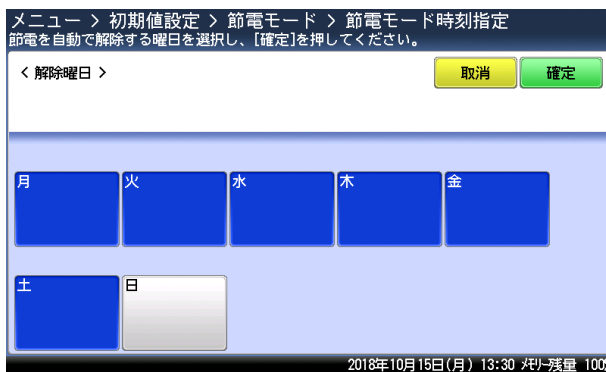

Information server が装着されているときは、手順はこれで終了です。

## 17 [最小電力モード] を押します。

## 18 [ON] または [OFF] を選択し、[確定] を押します。

## □ 節電モードの解除について

節電モードは〈節電〉を押すと、いつでも解除できます。

また、「モード1」が設定されているときは、下記のいずれの場合でも、節電モードを解除できます。

モード1に設定したときは、次の動作でも節電モードが解除できます。

- 自動原稿送り装置に原稿をセットしたとき
- 操作パネル上のキーを押したとき
- タッチパネルに触ったとき
- カセットやカバーを開けたとき

モード1とモード2で最小電力モードになっていないときは、次の場合に自動的に解除されます。

- 〈節電〉を押したとき
- 節電モード解除時刻になったとき
- ファクスを受信したとき
- 時刻指定送信で送信時刻になったとき
- PC-FAX を送信したとき
- パソコンからプリントアウトしたとき

## □ 最小電力モードの制限について

次の機能を設定している場合は、最小電力モードを ON に設定しても、最小電力モードにはなりません。

	設定	参照
ファクスの受信に関する設定	ファクス受信モードを、ファクス待機以外に設定している。	『スキャナー・ファクス編』第4章の「受信のしかた」の「受信モードを選択する」
	ファクス受信モードを、ファクス待機に設定しているときで、呼び出しベル回数を0回に設定している	『スキャナー・ファクス編』第8章の「初期値を設定する」の「ファクス機能の初期値を設定する」
	ファクシミリ通信網の設定を ON にしているとき	
	ナンバーディスプレイの設定を ON にしている	『スキャナー・ファクス編』第4章の「相手先を表示する (ナンバー・ディスプレイ)」
ネットワークの設定	アクセス制限を設定している。	『ネットワーク機能・Information server 編』第5章の「セキュリティを設定する」の「アクセス制限を設定する」
	IPv6 を設定している。	『ネットワーク機能・Information server 編』第4章の「ネットワーク環境を設定する (TCP/IP 設定)」
	プリントに使用するポートの設定で、IPP を ON にしている。	『ネットワーク機能・Information server 編』第5章の「セキュリティを設定する」の「マシンポリシーを設定する」

設定		参照
ネットワークの設定	インターネット時刻を設定している	『ネットワーク機能・Information server 編』第4章の「インターネット時刻を設定する」
接続	機器とコンピューターを USB ケーブルで接続しているときで、コンピューターの電源が入っている	—

次の場合は、最小電力モードは設定できません。

- Information server 装着時
- IC カード認証装置装着時

# 用紙に関する設定をする

受信やコピーに使用する用紙の選択など、用紙に関する設定ができます。

1

機器設定

## プリント時に使用するカセットを指定する

コピー、ファクス受信、リストプリントで使用するカセットを指定できます。

### 補足

オプションの増設給紙カセットが装着されていないときは表示されません。

- 1 〈メニュー〉を押します。
- 2 [機器設定] タブ、[用紙/仕分け] の順に押します。
- 3 [印字カセット指定] を押します。

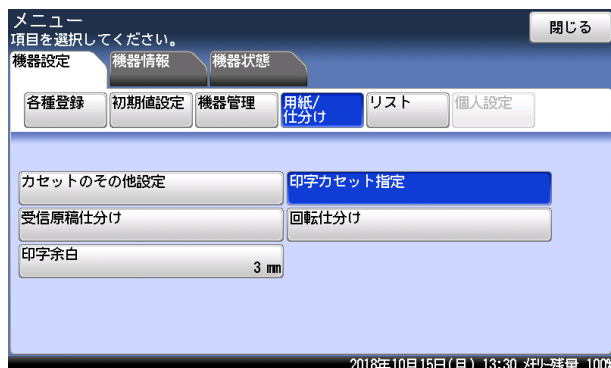

- 4 設定するモードを選択し、[確定] を押します。

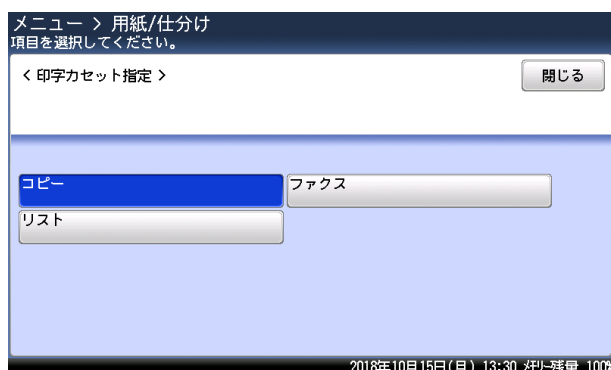

ここでは、例として [コピー画面] を選択します。

- 5 設定する給紙カセットを選択します。



## 6 設定を選択し、[確定] を押します。

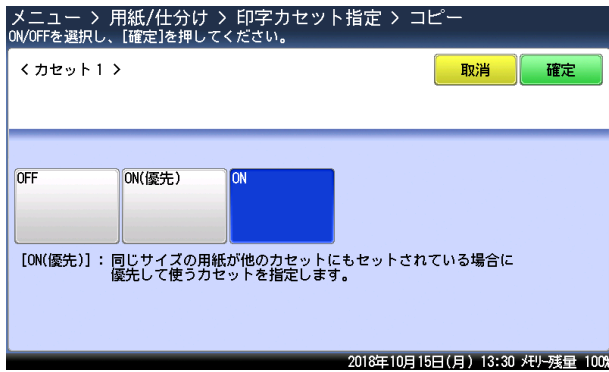

- ・ OFF : この給紙カセットにセットされている用紙を使用しない。
- ・ ON : この給紙カセットにセットされている用紙を使用する。
- ・ ON (優先) : この給紙カセットにセットされている用紙を使用する。同じ用紙がほかの給紙カセットにもセットされているときは、この給紙カセットを優先して使用する。

# 用紙／仕分け設定一覧

用紙／仕分け設定で設定した各種機能の設定状況は、機器設定リストでも確認できます。  
 (→ 1-24 ページ)

機能		機能説明	設定値
カセット その他設定	カセット 1	給紙カセットの用紙サイズダイヤルを「その他」にした場合は、セットした用紙のサイズを設定します。詳細は、『基本編』の「用紙をセットする」の「カセットに用紙をセットする」を参照してください。	16K、16K <input type="checkbox"/> 、Letter、Letter <input type="checkbox"/>
	カセット 2 <sup>1)</sup>		16K、16K <input type="checkbox"/> 、Letter、Letter <input type="checkbox"/> 、Legal、Legal 13
印字カセット指定 <sup>1)</sup>	コピー	コピー時に用紙選択を「自動」に設定している場合に、自動選択の対象とする給紙カセットを指定できます。	カセット 1～2 OFF ON ON (優先)
	ファクス	ファクス受信時に使用する給紙カセットを指定できます。	
	リスト	リスト印字に使用する給紙カセットを指定できます。  [OFF] この給紙カセットを使用しない。 [ON] この給紙カセットを使用する。 [ON (優先)] 同じサイズの用紙がほかの給紙カセットにもセットされている場合、この給紙カセットを優先して使用する。	
受信原稿仕分け <sup>1)</sup>		受信原稿の 1 枚目をプリントする給紙カセットを設定します。1 枚目と 2 枚目の用紙サイズや用紙の色を変えたりすることで、受信ごとに原稿を仕分けられます。  設定の詳細は、『スキャナー・ファクス編』第 4 章の「受信に関する設定」の「受信原稿を仕分けする」を参照してください。	設定 OFF、ON  カセット指定 カセット 1 カセット 2  先頭ページにプリントする OFF、ON

機能	機能説明	設定値
回転仕分け <sup>1)</sup>	コピー部ごと	<p>複数部のコピーをする場合に、1部ごと（仕分けが「ソート」に設定されているとき）またはページごと（仕分けが「ノンソート」に設定されているとき）に用紙の向きを変えて仕分けすることができます。</p> <p><b>補足</b></p> <ul style="list-style-type: none"> <li>・「コピー部ごと」回転仕分けできる用紙のサイズは A4 だけで、同じサイズの内紙がタテ、ヨコともに別々の給紙カセットにセットされていなければなりません。</li> <li>・「印字カセット指定」で、コピーで使用を許可している給紙カセットだけが使えます。</li> <li>・手動で給紙カセットを選択したときは、「回転仕分け」を行いません。給紙カセットを自動選択したときだけ有効です。</li> <li>・コピーの途中でどちらかの給紙カセットの内紙が無くなったときは、「回転仕分け」せずに残っている方の用紙を使ってコピーを続けます。</li> <li>・コピー部数が 1 部の場合は、「回転仕分け」はしません。</li> </ul>

機能	機能説明	設定値
回転仕分け <sup>1</sup> ジョブごと	コピー、ファクス、インターネットファクス、PCプリントやリストのプリント時などに、ジョブごとに用紙の向きを変えて仕分けすることができます。  <b>補足</b> <ul style="list-style-type: none"> <li>・「ジョブごと」回転仕分けできる用紙のサイズはA4だけで、同じサイズの内紙がタテ、ヨコともに別々の給紙カセットにセットされていなければなりません。</li> <li>・手動で給紙カセットを選択したときは、「回転仕分け」を行いません。給紙カセットを自動選択したときだけ有効です。</li> <li>・「印字カセット指定」で、使用を許可している給紙カセットだけが使えます。</li> <li>・プリントの途中でどちらかの給紙カセットの内紙が無くなったときは、「回転仕分け」せずに残っている方の用紙を使ってプリントを続けます。</li> <li>・上記以外でも、条件によっては回転仕分けできない場合があります。</li> </ul>	OFF ON
印字余白	用紙の端で、プリントされない範囲を指定できます。 主にコピー使用時に反映されます。 余白を少なく設定しても、プリンタードライバーからの印刷には反映されません。	1~4 mm : <u>3 mm</u>

\* 1 オプションの増設給紙カセットの装着が必要です。

**補足**

\_\_の付いている値が、工場出荷時の設定です。

# リストをプリントする

## プリントのしかた

ここでは、機器設定リストのプリントを例に説明します。

- 1 〈メニュー〉を押します。
- 2 [機器設定] タブ、[リスト] の順に押します。

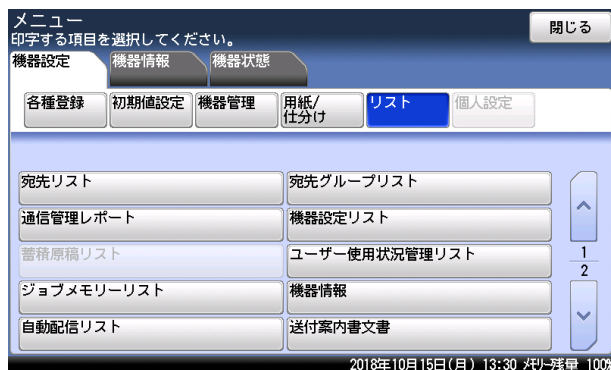

- 3 [機器設定リスト] を押します。

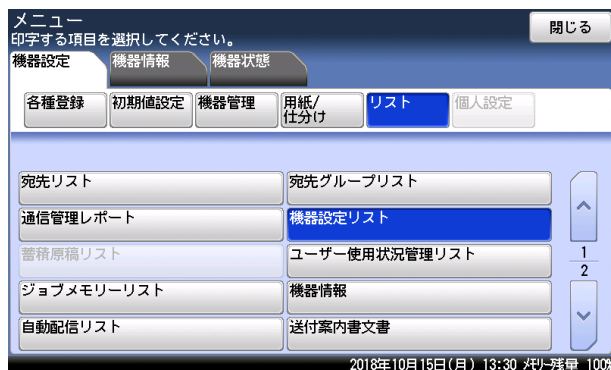

- 4 [はい] を押します。

- ・「ページ集約」を [ON] にすると、リスト 2 枚分を 1 枚の用紙に並べてプリントします。
- ・パンチの目印になるセンターマークをプリントできます。センターマークを付けたい位置を選択します。

# リスト一覧

リスト名	プリント内容	参照ページ
宛先リスト	宛先表に登録されている宛先の一覧をプリントします。	『スキャナー・ファクス編』第8章の「宛先を登録する」の「宛先を登録・変更する」
宛先グループリスト	宛先グループとして登録されている宛先の一覧をプリントします。	『スキャナー・ファクス編』第8章の「宛先を登録する」の「宛先グループを登録・変更する」
通信管理レポート	ファクスの送受信、電子メールの送受信* <sup>2</sup> 、スキャン to フォルダー* <sup>2</sup> 、スキャン to FTP サーバー* <sup>2</sup> の送信結果の一覧をプリントします。	『スキャナー・ファクス編』第7章の「通信履歴を管理する」
機器設定リスト	<メニュー>→[機器設定]タブの「初期値設定」、「機器管理」、「用紙/仕分け」の設定内容をプリントできます。	1-24
蓄積原稿リスト	ポーリング原稿、Fコード原稿、送信予約原稿、受信原稿、PCファクス送信原稿など、蓄積原稿のリストをプリントします。	『スキャナー・ファクス編』第4章
ユーザー使用状況管理リスト	各モードで使用したページ数をユーザーごとにカウントし、料金とファクス通信時間の合計をプリントできます。 ユーザーが機器にログインせずに使用した場合は、ゲストユーザーとして集計されます。	2-13
ジョブメモリーリスト	登録されているジョブメモリーの一覧をプリントします。	1-8
機器情報	機器のIPアドレスやネットワーク設定、オプションや消耗品の状態、各モードのプリント枚数などをプリントします。	1-27
自動配信リスト	設定されている配信条件の一覧をプリントします。	『スキャナー・ファクス編』第4章の「受信に関する設定」の「受信原稿を配信する(自動配信)」
送付案内書文書 <sup>*1</sup>	登録されている送付案内書の内容をプリントします。	『スキャナー・ファクス編』第4章の「送信に関する設定」の「送付案内書を付ける (Information server を装着していないとき)」
Fコードボックスリスト	登録されているFコードボックスの一覧をプリントします。	『スキャナー・ファクス編』第4章の「Fコード通信をする」の「Fコードボックスを登録する」
ダイレクトメール防止リスト	ダイレクトメール防止の設定内容をプリントします。	『スキャナー・ファクス編』第4章の「セキュリティー機能」の「ダイレクトメールを防止する」

リスト名	プリント内容	参照ページ
LDAP 設定リスト <sup>*2</sup>	登録されている LDAP サーバーの一覧をプリントします。	2-25
ルート証明書リスト <sup>*2</sup>	プライベート認証局のルート証明書の拇印（フィンガープリント）をプリントできます。	—
通信予約リスト	予約されている通信ジョブの一覧をプリントします。	『スキャナー・ファクス編』第7章の「通信予約を管理する」

\* 1 オプションの Information server が装着されているときは表示されません。

\* 2 オプションの Information server が必要です。

# 機器情報を確認する

メニュー画面にある機器情報で、機器の IP アドレスやネットワーク設定、オプションや消耗品の状態、各モードのプリント枚数などが確認できます。

## 補足

- ・〈メニュー〉 → [機器設定] タブ → [リスト] → [機器情報] から機器情報をプリントできます。
- ・機器情報に表示されるの消耗品の残量表示は、大まかな目安としてください。

- 1 〈メニュー〉を押します。
- 2 [機器情報] を押します。
- 3 確認したい機器情報の項目を選択し、機器情報を確認します。

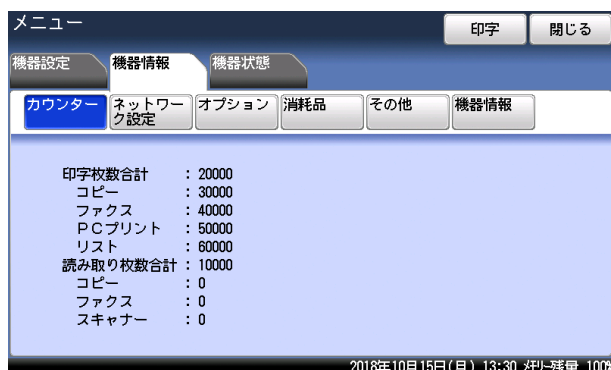

- 4 プリントする場合は [印字] を押します。  
プリントしない場合は [閉じる] を押します。
- 5 [はい] を押します。
  - ・「ページ集約」を [ON] にすると、リスト 2 枚分を 1 枚の用紙に並べてプリントします。
  - ・パンチの目印になるセンターマークをプリントできます。センターマークを付けたい位置を選択します。



# ログインする／ログアウトする

ユーザー認証を受けて機器を使用するときは、ログインします。ログインすると、以下の機能が利用できます。

- 個人設定
- 送信者情報（ユーザー登録された情報の利用）
- セキュリティープリント
- ユーザー使用状況管理
- 通信管理レポート（送信者欄にユーザー名をプリント）
- スキャンパス通知（オプションの Information server が必要です）

## 補足

ユーザーの登録については、『ネットワーク機能・Information server 編』第3章の「使用するユーザーを登録する」を参照してください。

## ログインする

- 1 〈ログイン〉を押します。
- 2 ユーザー名を選択し、[確定]を押します。

The screenshot shows a login window titled "ログイン" (Login). Below the title, it says "ユーザー名を選択し、[確定]を押してください。" (Select a user name and press [OK]). There is a text input field labeled "ユーザー名" (User name) with a "ユーザー名入力" (User name input) button next to it. To the right of the input field are "取消" (Cancel) and "確定" (OK) buttons. Below the input field is a list of ten user names: 001:ユーザー01, 002:ユーザー02, 003:ユーザー03, 004:ユーザー04, 005:ユーザー05, 006:ユーザー06, 007:ユーザー07, 008:ユーザー08, 009:ユーザー09, and 010:ユーザー10. The list is displayed in two columns. To the right of the list are up and down arrow buttons and a page indicator showing "1" and "2". At the bottom of the window, the date and time "2018年10月15日(月) 13:30" and "残り残量 100%" (Remaining battery 100%) are displayed.

- ・ [ユーザー名入力] を押すと、ユーザー名を直接入力できます。
- ・ マシンポリシーの設定によっては、ユーザー名選択画面ではなくユーザー名入力画面が表示されます。

- 3 パスワードを入力し、[確定]を押します。  
パスワードを設定していない場合は、この手順は不要です。

## 補足

- マシンポリシー設定については、『ネットワーク機能・Information server 編』第5章の「セキュリティーを設定する」の「マシンポリシーを設定する」を参照してください。
- ゲストアカウントの設定が無効になっている場合は、機器を使用するときにログインが必要です。登録されているユーザーが一人で、パスワードが設定されていないときは、そのユーザーで自動的にログインします。

## ログアウトする

---

ログアウトするには、手動でログアウトする方法と自動的にログアウトする方法があります。ここでは、手動でログアウトする方法を説明します。

### 補足

- 自動ログアウト時間の設定については、「[自動ログアウト時間を設定する](#)」(2-37 ページ) を参照してください。
- 読み取り終了後にログアウトするように設定できます。設定の詳細は、「[画面自動リセット時間](#)」(1-11 ページ) を参照してください。

- 1 **〈ログイン〉** を押します。
- 2 **〔はい〕** を押します。  
〔いいえ〕 を押すと、ログアウトしません。

## IC カードでログインする

---

オプションの IC カード認証装置が装着されている場合は、IC カードを読み取り部にかざすことでログインできます。

### 補足

- オプションの IC カード認証装置が必要です。
- あらかじめ IC カード認証の設定を有効にしてください。(→ [2-38 ページ](#)) また、カードとユーザーを登録してください。(→ [2-40 ページ](#))

- 1 **IC カードを読み取り部にかざします。**  
パスワードを設定していない場合や認証方法を「IC カード認証」に設定している場合は、「(ユーザー名) ログインしました。」と表示され、機器にログインされます。  
認証方法を「IC カード認証 + パスワード」に設定している場合は、次の手順に進みます。
- 2 **パスワードを入力し、〔確定〕 を押します。**

# 個人設定を使用する

個人設定では、ユーザーごとに設定をカスタマイズできます。  
個人設定を表示するには、ログインが必要です。

## 個人設定をする

ここでは、優先画面表示の設定を例に説明します。

- 1 ログイン操作を行います。(→ 1-28 ページ)
- 2 <メニュー> を押します。
- 3 [機器設定] タブ、[個人設定] の順に押します。

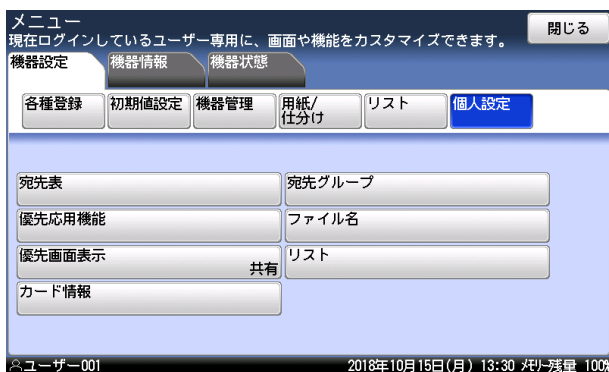

ユーザーログインをしていない状態で [個人設定] を押すと、「ログインしてください」というメッセージが表示されます。

- 4 [優先画面表示] を押します。

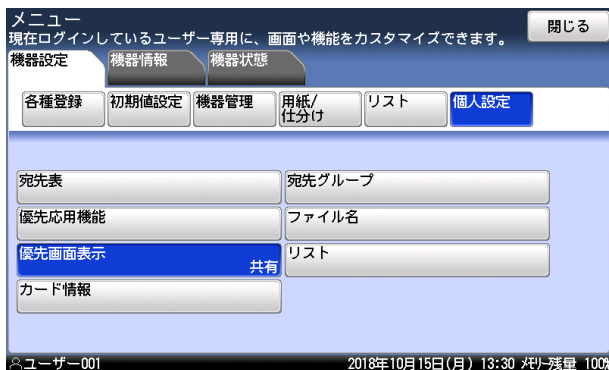

設定項目の詳細は、「個人設定一覧」を参照してください。(→ 1-31 ページ)

- 5 [共有] または [個人] を選択し、[確定] を押します。

# 個人設定一覧

機能	機能説明	設定値	参照ページ
宛先表	ユーザーごとに宛先の登録、変更、または削除ができません。		『スキャナー・ファクス編』第8章の「宛先を登録する」の「宛先を登録・変更する」
宛先グループ	ユーザーごとに宛先グループの登録、変更、削除、またはリストのプリントができます。		『スキャナー・ファクス編』第8章の「宛先を登録する」の「宛先グループを登録・変更する」
優先応用機能	ユーザーログインしたときのコピー画面、ファクス画面、スキャナー画面の優先応用機能を設定できます。	優先応用機能カスタマイズ OFF ON	1-4
お気に入り宛先* 1	ユーザーごとにスキャナー画面のお気に入りタブに表示する宛先を登録、変更、または削除できます。		『スキャナー・ファクス編』第8章の「宛先を登録する」の「お気に入り宛先を登録する」
フォルダーショートカット*1	ユーザーごとに共有フォルダーのパスをショートカットとして登録、変更、または削除できます。		『スキャナー・ファクス編』第8章の「宛先を登録する」の「フォルダーショートカットを登録・変更する」
ファイル名	ユーザーごとにファイル名の登録、変更、または削除ができます。		『スキャナー・ファクス編』第8章の「その他の登録をする」の「ファイル名を登録・変更する」
文書分類名*1	ユーザーごとに文書分類名の登録、変更、または削除ができます。		『スキャナー・ファクス編』第8章の「その他の登録をする」の「文書分類名を登録・変更する」
定型文*1	ユーザーごとに定型文の登録、変更、または削除ができます。		『スキャナー・ファクス編』第8章の「その他の登録をする」の「定型文を登録・変更する」
送信確認証*1	ユーザーごとにファクスの送信確認証を設定できます。	個人設定 OFF ON 送信確認証設定 OFF 印字 メール	『スキャナー・ファクス編』第7章の「送信結果を確認する（送信確認証）」
優先画面表示	ユーザーログインしたときに表示する画面を、共有設定または個人設定のいずれかから選択できます。	共有 個人	—
リスト	個人宛先表の宛先リストと個人宛先グループのリストをプリントできます。		『スキャナー・ファクス編』第8章の「宛先を登録する」の「宛先を登録・変更する」
カード情報	オプションの IC カード認証装置が装着されている場合は、ユーザーのカード情報が登録できます。		2-40

\* 1 オプションの Information server が必要です。

## 補足

\_\_の付いている値が、工場出荷時の設定です。

# 個人画面・共有画面を切り替える

ログイン中に、共有画面に切り替えるには [共有 / 個人] を押します。再び、個人画面に切り替えるには、[共有 / 個人] を押します。

## 1 ログインしているときに、[共有 / 個人] を押します。



# 文字を入力する

発信元や宛先表の相手先など、文字を入力するときに参照してください。

入力できる文字は、漢字（全角）、ひらがな（全角）、カタカナ（全角／半角）、英字（全角／半角）、数字（全角／半角）、記号（全角／半角）です。

漢字は JIS 第一水準、JIS 第二水準が入力できます。

## 文字入力画面について

### □ 文字入力画面

ひらがなを入力しているときの画面の例です。



### □ 変換候補選択画面

ひらがなを入力中に [変換] を押すと、漢字の変換候補が表示されます。

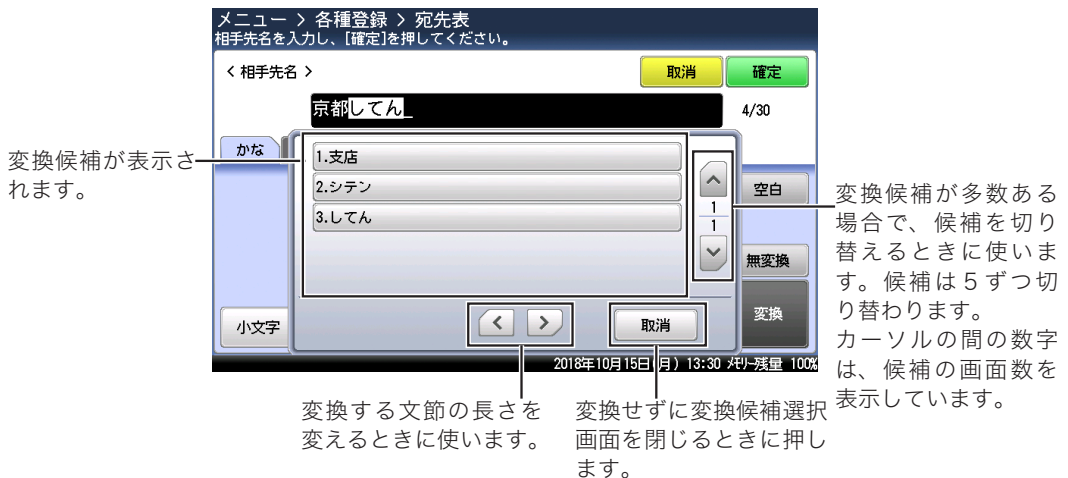

# 文字入力について

## □ 確定と未確定

文字が反転表示されているときは変換できる状態です。これを「未確定」といいます。[無変換]を押して、文字が変換できない状態に（入力を決定）することを「確定」といいます。未確定の文字は 14 文字まで入力できます。



### 補足

かな入力モードで入力した文字は、すべて未確定になります。それ以外の入力モードでは確定した状態で入力されます。

## □ 全角と半角

文字を入力するとき、全角文字と半角文字があります。全角は半角の 2 倍の大きさです。半角文字で 24 文字入力できる場合、全角文字では 12 文字入力できます。

## □ 文節表示

変換途中の文字は、文節と呼ばれる単位で区切られて表示されます。複数の文節がある場合は、初めの文節だけが変換対象になります。変換対象になっている文節は背景が白く表示されます。

文節の長さを変えるには、[<] と [>] を使用します。

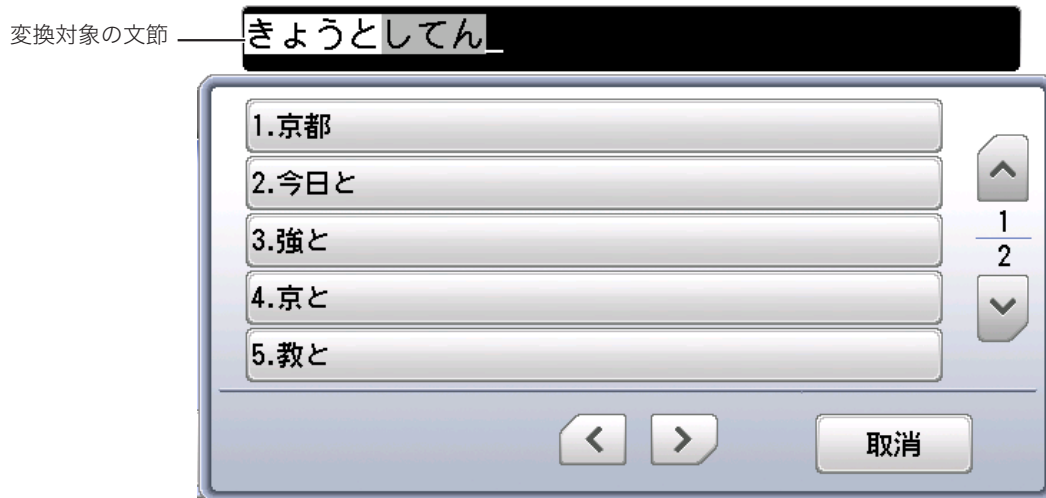

# 漢字・ひらがなを入力する

## □ 漢字・ひらがなを入力する

- 1 [かな] タブを押して、文字入力画面にひらがなを表示させます。
- 2 入力する文字を押します。



° (濁点) や ° (半濁点) を入力するときは、文字を入力したあとに、[°] や [°] を押します。

- 3 漢字に変換する場合は、[変換] を押します。

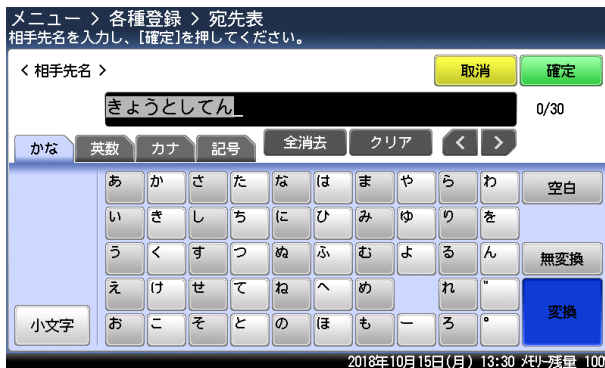

ひらがなを入力する場合は、[無変換] を押します。

- 4 変換したい漢字を選択します。

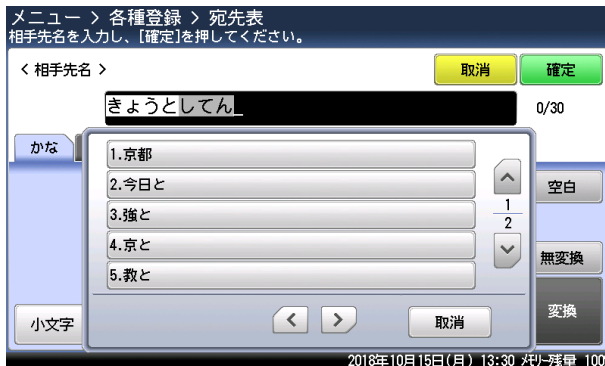

- ・変換候補が多数あるときは、[^] や [v] を使って表示を切り替えます。
- ・[<] や [>] を押すと、変換する文節の長さを変更できます。(→ 1-34 ページ)
- ・[取消] を押すと、手順 3 の画面に戻ります。



## □ 小文字を入力する

- 1 [かな] タブを押して、文字入力画面にひらがなを表示させます。
- 2 [小文字] を押して、小文字を表示させてます。

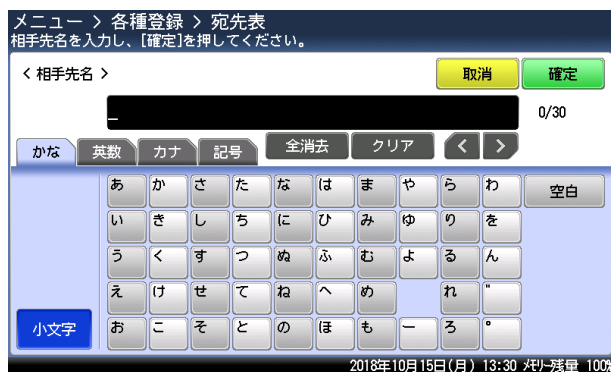

- 3 入力する文字を押します。

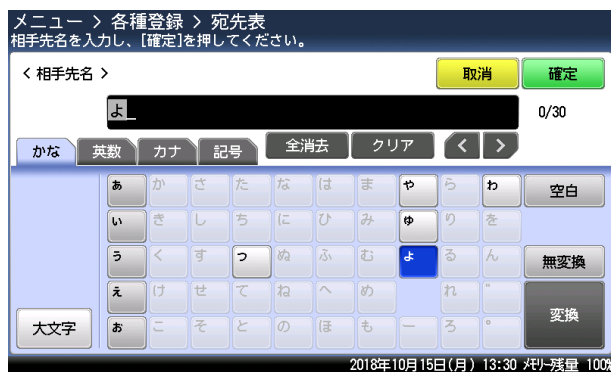

再び大文字を入力するときは、[大文字] を押します。

# カタカナを入力する

## 1 [カナ] タブを押して、文字入力画面にカタカナを表示させます。

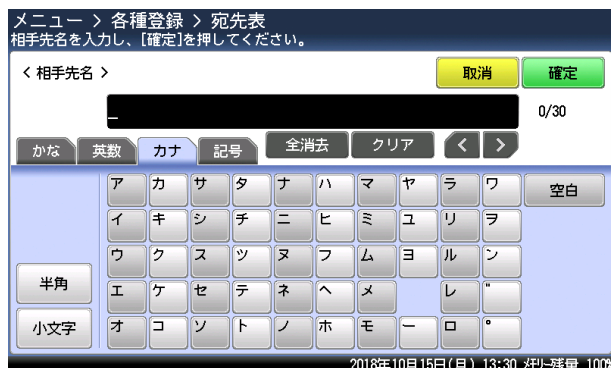

## 2 入力する文字を押します。

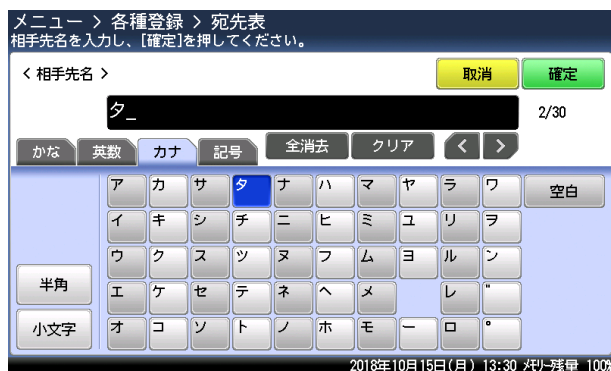

- ・ ° (濁点) や ° (半濁点) を入力するときは、文字を入力したあとに、[°] や [°] を押します。
- ・ 小文字を入力するときは、[小文字] を押します。再び大文字を入力するときは、[大文字] を押します。
- ・ 半角のカタカナを入力するときは、[半角] を押します。再び全角のカタカナを入力するときは、[全角] を押します。

# 英数字を入力する

アルファベットと数字が入力できます。

## 1 [英数] タブを押して、文字入力画面にアルファベットを表示させます。



## 2 入力する文字を押します。

- ・アルファベットの太文字を入力するときは、[大文字] を押します。再び小文字を入力するときは、[小文字] を押します。
- ・全角のアルファベットを入力するときは、[全角]を押します。再び半角のアルファベットを入力するときは、[半角] を押します。

# 記号を入力する

## 1 [記号] タブを押して、文字入力画面に記号を表示させます。

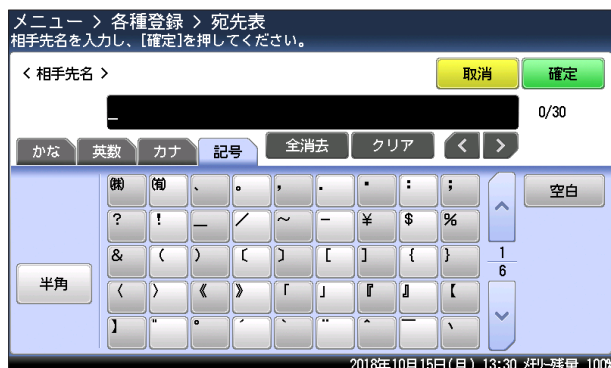

## 2 入力する記号を押します。

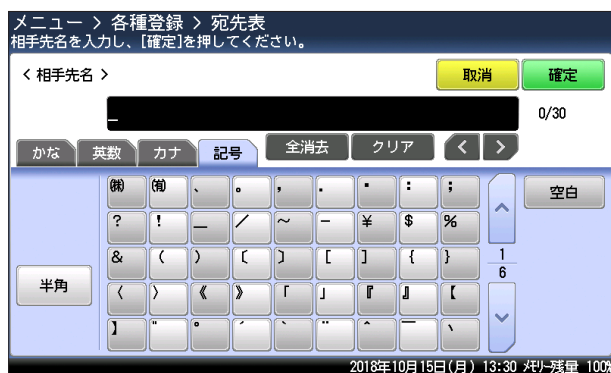

半角の記号を入力するときは、[半角]を押します。再び全角を入力するときは、[全角]を押します。全角と半角では入力できる記号の種類が違います。

# 数字を入力する

---

- 1 テンキーを押して、数字を入力します。



- ・全角の入力画面のときは、全角の数字が入力されます。半角の入力画面のときは、半角の数字が入力されます。
- ・数字は英数字の文字入力画面からも入力できます。

# 空白（スペース）を入力する

---

- 1 [空白] を押します。

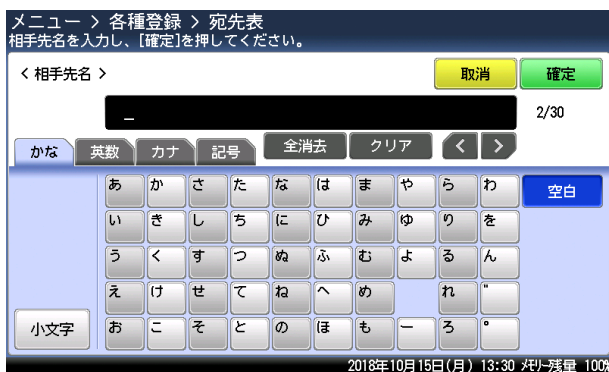

- ・全角の入力画面のときは、全角の空白が入力されます。半角の入力画面のときは、半角の空白が入力されます。

# ドメイン名を入力する

メールアドレスを入力する場合などに、ドメイン名ボタンを利用して、ドメイン名を簡単に入力できます。

## 補足

ドメイン名の登録のしかたは、『スキャナー・ファクス編』第8章の「その他の登録をする」の「ドメイン名を登録・変更する」を参照してください。

- 1 [英数] タブを押して、文字入力画面にアルファベットを表示させます。
- 2 [.co.jp] または [ドメイン名] を押します。



- ・ドメイン名が登録されていないときは、[co.jp] が表示されます。
- ・ドメイン名が登録されているときは、[ドメイン名] が表示されます。
- ・ドメイン名を登録していないときは、「.co.jp」が入力されます。これで手順は終了です。

- 3 入力したいドメイン名を押します。

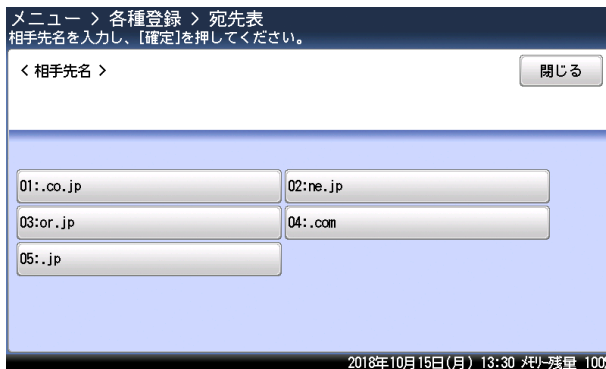

# 文字を削除する・挿入する

文字を削除するには、削除したい文字までカーソルを移動し、[クリア] を押します。  
文字を挿入するには、挿入したい位置までカーソルを移動し、文字を入力します。

## □ 文字を削除する

- 1 [ < ] または [ > ] を押して、削除したい文字の位置までカーソルを移動します。

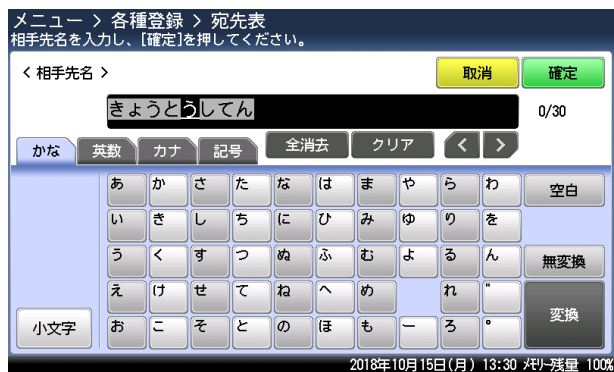

- 2 [クリア] を押します。  
直前に入力した文字は、[クリア] を押すだけで削除できます。

## □ 文字を挿入する

- 1 [ < ] または [ > ] を押して、挿入したい位置の右側までカーソルを移動します。

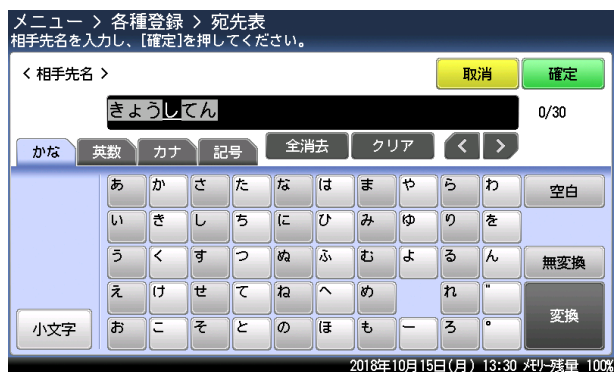

- 2 文字を入力します。  
カーソルの前に入力した文字が挿入されます。

# 第 2 章

## 管理設定

---

機器管理設定一覧 .....	2-2
セキュリティーコードを設定する .....	2-4
管理者パスワードを設定する .....	2-4
プロテクトコードを設定する .....	2-6
設定や操作を制限する (機能プロテクト設定) .....	2-8
機能プロテクトを設定する .....	2-9
機能プロテクトを使う .....	2-11
モード禁止設定をする .....	2-12
ユーザー使用状況を管理する .....	2-13
通貨単位を設定する .....	2-13
料金を設定する .....	2-15
ユーザー使用状況管理リストをプリントする .....	2-16
集計データを消去する .....	2-17
ネットワーク設定をする .....	2-18
TCP / IP 設定をする .....	2-19
LDAP サーバーを登録する .....	2-21
LDAP サーバーを削除する .....	2-25
LDAP 設定リストをプリントする .....	2-25
アーカイブ設定をする .....	2-26
ユーザー認証方法を設定する .....	2-30
機器設定をコピーする .....	2-31
USB メモリーにエクスポートする .....	2-31
USB メモリーから機器にインポートする .....	2-34
自動ログアウト時間を設定する .....	2-37
IC カード認証を設定する .....	2-38
IC カード認証を有効にする .....	2-38
認証方法を設定する .....	2-39
IC カード情報を登録する .....	2-40
セキュリティープリントのオートリリース機能を設定する .....	2-42



# 機器管理設定一覧

設置モードやセキュリティー通信機能の設定、ネットワーク設定など、機器に関する重要な設定ができます。

管理者パスワードを設定しておくとし、[機器管理] を押すたびに管理者パスワードを入力する画面が表示され、管理者以外による設定変更には制限をかけられます（一度管理者パスワードを入力すると、[機器設定] タブ内の設定は続けて行えます）。

機能	機能説明	設定値	参照ページ
セキュリティー通信機能	閉域通信やIDチェック送信、宛先確認、セキュリティー受信など、さまざまなセキュリティー通信の設定ができます。	閉域送信、閉域受信、IDチェック送信、宛先2度押し、ダイヤル2度押し、パスコードボーリング OFF ON  パスコード 0000～9999： (登録なし)  宛先確認 OFF ON 同報のみ  同報送信 OFF ON  セキュリティー受信 OFF ON (現在時刻)  ダイレクトメール防止 OFF ON	『スキャナー・ファクス編』第4章の「セキュリティー機能」
機能プロテクト設定	管理者パスワードやプロテクトコードを利用して、さまざまな機能を管理できます。	プロテクトしない プロテクトする 禁止	2-9
モード禁止設定	コピー・スキャナー・ファクス・プリンターの使用禁止を設定できます。	OFF ON	2-12
ユーザー使用状況管理	各ユーザーのコピーやファクスの総ページ数や通信時間の累計をリセットできます。	—	2-13
ネットワーク設定	機器をネットワーク上で使用するためのネットワーク設定ができます。	—	2-18
設置モード	機器を使用するために必要な設定ができます。	—	『スキャナー・ファクス編』第8章の「初期設定をする(設置モード)」

機能	機能説明	設定値	参照ページ
機器設定コピー	機器設定データを同機種のほかの機器へコピーできます。	—	2-31
全データ/設定の初期化	宛先表やコピー・ファクスの機能設定、蓄積文書など、[機器設定] タブで設定されているデータや機器に保存されているデータを消去できます。データ消去後は一度電源スイッチを OFF にしてください。  △注意 一度消去したデータは復旧できません。	—	—
管理者パスワード	管理者パスワードを設定できます。管理者パスワードを設定すると、管理者以外による「機器管理」内の設定変更に制限がかけられます。	出荷時には管理者パスワードは設定されていません。	2-4
プロテクトコード	プロテクトコードを設定できます。プロテクトコードは機能プロテクト設定やセキュリティー受信を使用するときが必要です。	出荷時にはプロテクトコードは設定されていません。	2-6
自動ログアウト時間	何も操作しなかった場合に、ログイン状態から自動的にログアウトするまでの時間を設定します。	1-10分： <u>3分</u>	2-37
IC カード認証	オプションの IC カード認証装置が装着されている場合のみ、認証の詳細が設定できます。	OFF ON	2-38

#### 補足

\_\_の付いている値が、工場出荷時の設定です。

# セキュリティーコードを設定する

機器にはセキュリティーを設定する「鍵」として、管理者パスワードとプロテクトコードの2種類の鍵が設けられます。

管理者パスワードを設定すると、[機器管理] 設定の操作に制限をかけることができます。プロテクトコードは、機能プロテクト設定により操作制限をかけられた機能や、セキュリティー受信機能を使用するときに必要な4桁の数字です。

## 管理者パスワードを設定する

管理者パスワードは、半角のアルファベットと数字、記号、スペースで28文字まで入力できます。設定後はパスワードを控え、保管してください。

### ！お願い

管理者パスワードを忘れた場合は、機器を初期化して再設定する必要があります。お買い上げの販売店、またはNTT通信機器お取扱相談センタ(裏表紙)へご連絡ください。

### □ 管理者パスワードを設定する

- 1 〈メニュー〉を押します。
- 2 [機器設定] タブ、[機器管理] の順に押します。
- 3 [管理者パスワード] を押します。

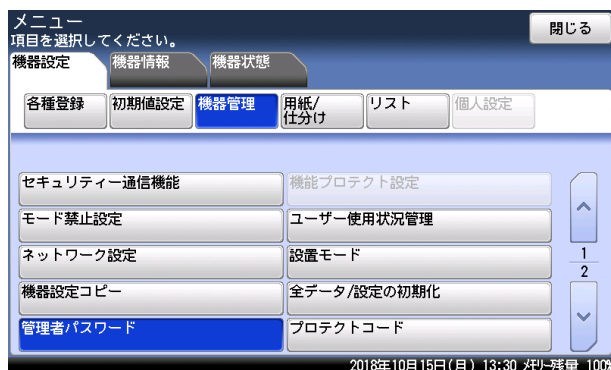

#### 4 設定したいパスワードを入力し、[確定] を押します。

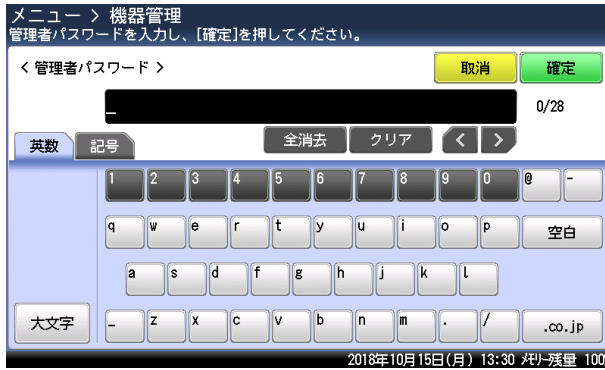

半角のアルファベットと数字、記号、スペースで 28 文字まで入力できます。

#### 5 再度パスワードを入力し、[確定] を押します。

### □ 管理者パスワードを変更する・削除する

パスワードを削除したい場合は、新しいパスワードを何も入力せずに、[確定] を押します。

- 1 〈メニュー〉を押します。
- 2 [機器設定] タブ、[機器管理] の順に押します。
- 3 管理者パスワードを入力し、[確定] を押します。

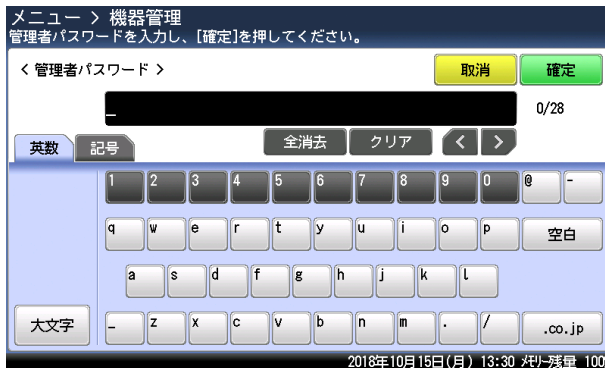

- 4 [管理者パスワード] を押します。
- 5 新しいパスワードを入力し、[確定] を押します。
  - ・半角のアルファベットと数字、記号で 28 文字まで入力できます。
  - ・パスワードを削除したい場合は、新しいパスワードを何も入力せずに、[確定] を押します。
- 6 再度新しいパスワードを入力し、[確定] を押します。
 

パスワードを削除したい場合は、新しいパスワードを何も入力せずに、[確定] を押します。

# プロテクトコードを設定する

プロテクトコードは任意の4桁の数字を設定できます。設定後は番号を控え、保管してください。

## □ プロテクトコードを設定する

- 1 〈メニュー〉を押します。
- 2 [機器設定] タブ、[機器管理] の順に押します。
- 3 管理者パスワードを設定している場合は、管理者パスワードを入力し、[確定]を押します。  
管理者パスワードを設定していない場合は、そのまま次の手順に進みます。
- 4 [プロテクトコード] を押します。

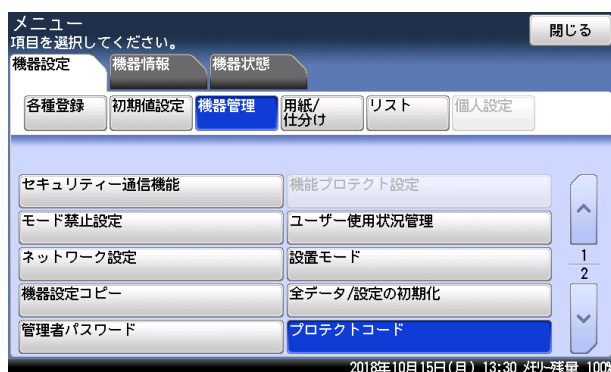

- 5 プロテクトコードを入力し、[確定]を押します。

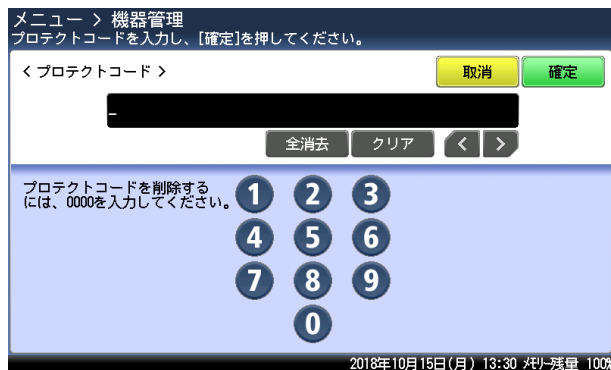

4桁の数字を入力してください。

## □ プロテクトコードを変更する・削除する

- 1 〈メニュー〉を押します。
- 2 [機器設定] タブ、[機器管理] の順に押します。
- 3 管理者パスワードを設定している場合は、管理者パスワードを入力し、[確定]を押します。  
管理者パスワードを設定していない場合は、そのまま次の手順に進みます。
- 4 [プロテクトコード] を押します。
- 5 現在のプロテクトコードを入力し、[確定] を押します。
- 6 新しいプロテクトコードを入力し、[確定] を押します。

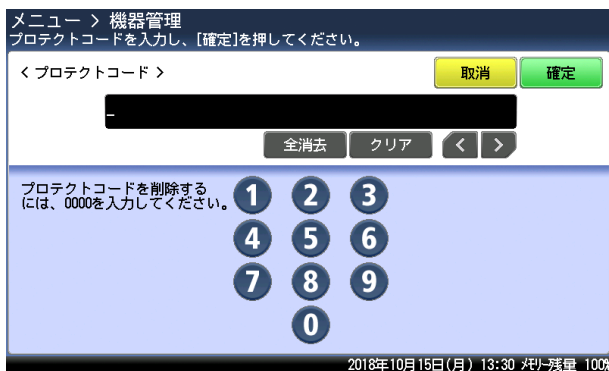

プロテクトコードを削除する場合は、「0000」と入力し、[確定] を押します。

# 設定や操作を制限する（機能プロテクト設定）

管理者パスワードやプロテクトコードを利用して機能を管理できます。  
管理できる機能は以下のとおりです。

操作をプロテクトできる機能		プロテクトの種類		
		禁止	プロテクトする	プロテクトしない
ファクス送信・インターネットファクス送信 <sup>*1</sup>	短縮ダイヤル (宛先表からの送信)	操作不可 「使用禁止設定されています。 管理者にお問い合わせください。」 と表示する	操作時に、 プロテクト コードを入力	制限なし
	直接ダイヤル (テンキーを使った送信)			
	宛先グループ送信			
	手動送信 (ハンドセットや [オンフック] を使った送信)			
	リダイヤル			
	閉域送信 <sup>*2</sup>			
	ID チェック送信 <sup>*2</sup>			
	メールアドレス <sup>*1</sup> (メールアドレスを直接入力 して送信)			
	メール履歴 <sup>*1</sup> (メール履歴を使った送信)			
	ジョブメモリー実行			
	F コード送信			
	自動配信 <sup>*2</sup>			
	メモリー送信 <sup>*2</sup>			
	分割送信 <sup>*2</sup>			
機器設定	宛先登録	操作時に、 管理者パスワードを入力して使用可能		
	宛先グループ登録			
	ポーリング原稿			
	F コード原稿			
	ジョブメモリー登録			
	F コードボックス (F コードボックスの登録)			
リスト	宛先リスト			
	宛先グループリスト			
	通信管理レポート			
	ジョブメモリーリスト			
	自動配信リスト			
	F コードボックスリスト			
通信履歴	通信履歴 (通信履歴の表示)			

\* 1 オプションの Information server が必要です。

\* 2 禁止に設定されている場合でも、〈メニュー〉から設定を変更するときは、管理者パスワードを入力すると設定変更できます。

## 補足

- 宛先表送信、短縮ダイヤル、テンキー、リダイヤルをプロテクトしていても、手動送信の場合はプロテクトできません。手動送信の場合で、宛先表送信短縮ダイヤル、テンキー、リダイヤルをプロテクトするには、「手動送信」をプロテクト設定してください。
- 手動送信を禁止またはプロテクトすると、〈スタート〉を押したときに「設定や操作を制限する（機能プロテクト設定）」（2-8 ページ）の表に書かれている動作になります。

## 機能プロテクトを設定する

## 補足

機能プロテクトを設定する場合は、あらかじめ管理者パスワード（→ 2-4 ページ）とプロテクトコード（→ 2-6 ページ）を設定しておく必要があります。

- 1 〈メニュー〉を押します。
- 2 [機器設定] タブ、[機器管理] の順に押します。
- 3 管理者パスワードを入力し、[確定] を押します。
- 4 [機能プロテクト設定] を押します。

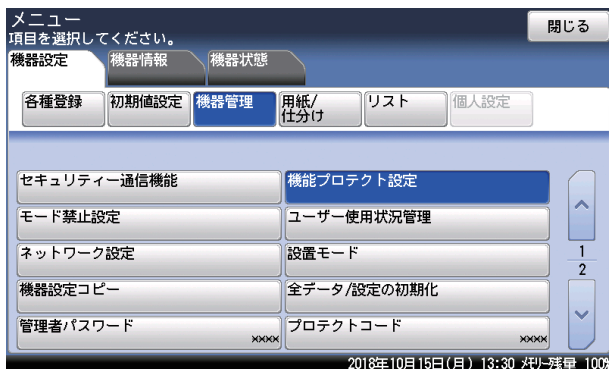

- 5 プロテクトコードを入力し、[確定] を押します。
- 6 設定・変更したい機能を選択します。

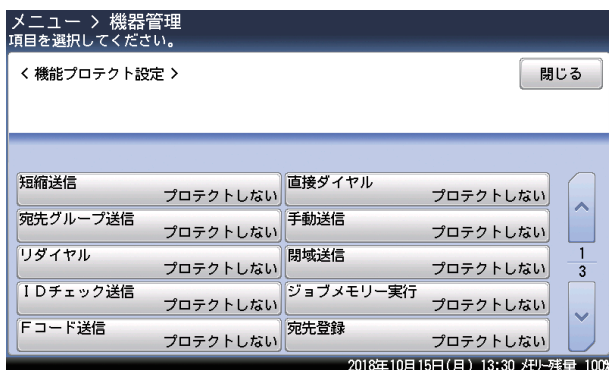



## 7 プロテクトの種類を選択し、[確定] を押します。

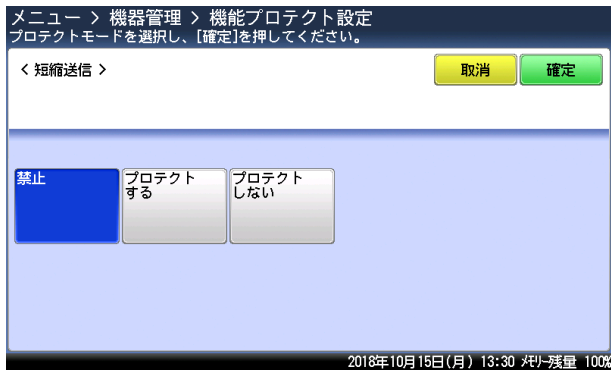

# 機能プロテクトを使う

ファクス機能・インターネットファクス機能を「禁止」に設定した場合機能プロテクト設定で「禁止」に設定した機能は使用できません。使用しようとすると画面に「使用禁止設定されています。管理者にお問い合わせください。」というメッセージが表示されます。

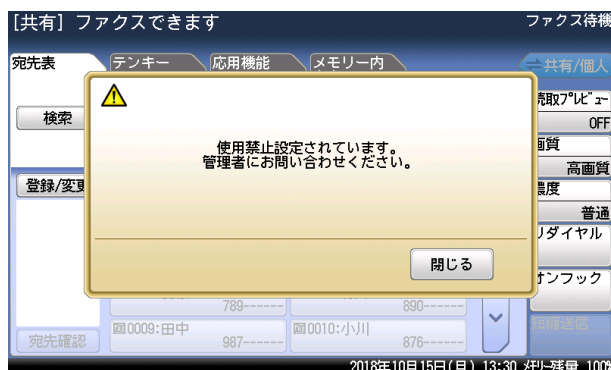

インターネットファクス機能を利用するには、オプションの Information server が必要です。

機器設定やリストの出力、通信履歴の表示を「禁止」に設定した場合機能プロテクト設定で機器設定やリストの出力、通信履歴の表示を「禁止」に設定した場合は、その機能を使用するときに管理者パスワードの入力が要求されます。

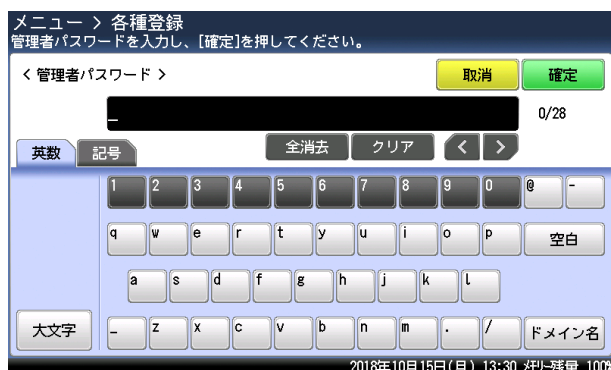

「プロテクトする」に設定した場合機能プロテクト設定で「プロテクトする」を設定した場合は、その機能を利用するときにプロテクトコードの入力が必要です。

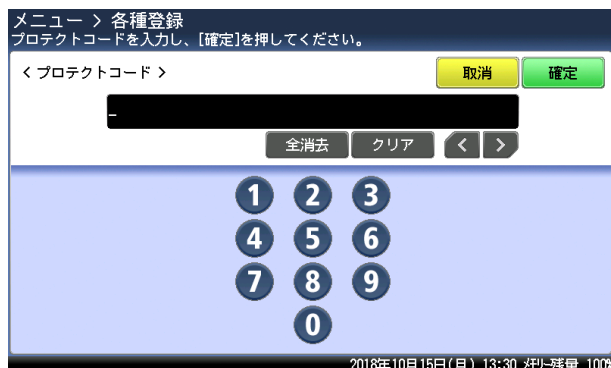

# モード禁止設定をする

コピー機能、スキャナー機能、ファクス機能、プリント機能を使用できないように設定できます。

## 補足

「プリント禁止」を ON に設定すると、リスト出力、オンライン、セキュリティープリントの操作を禁止します。

- 1 <メニュー> を押します。
- 2 [機器設定] タブ、[機器管理] の順に押します。
- 3 管理者パスワードを設定している場合は、管理者パスワードを入力し、[確定] を押します。  
管理者パスワードを設定していない場合は、そのまま次の手順に進みます。
- 4 「モード禁止設定」を押します。

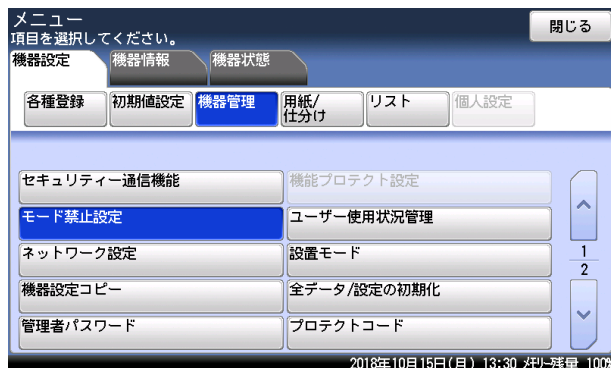

- 5 設定したい機能を選択します。

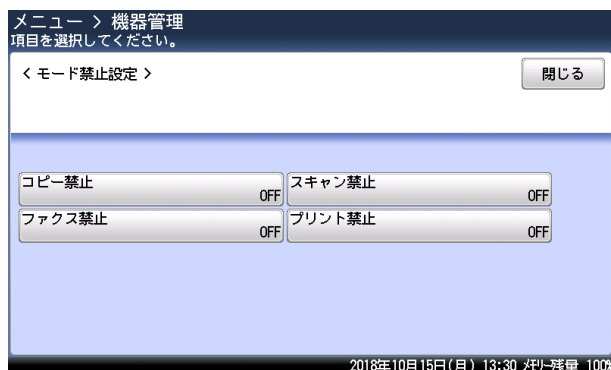

- 6 「ON」を選択し、[確定] を押します。

# ユーザー使用状況を管理する

この機能を使用すると、ユーザーごとのコピー、ファクス、スキャン、プリントそれぞれの総ページ数やファクス通信時間などを確認できます。また、1 ページあたりの単価を設定して、各ユーザーが使用したコピーやファクスなどの合計料金を集計できます。ユーザーが機器にログインして使用した場合はユーザーごとに、ログインせずに使用した場合はゲストユーザーとして、それぞれ集計されます。

## 操作の流れ

- 1 通貨単位を設定します（下記参照）
- 2 料金設定でコピー、ファクス、スキャン、プリントの設定を ON にし、1 枚あたりの単価を設定します。（→ 2-15 ページ）
- 3 コピー、スキャン、ファクス、プリントを使用します。ユーザーごとに管理したいときは、管理したいユーザーでログインして使用します。
- 4 ユーザー使用状況管理リストをプリントして使用状況を確認する。（→ 2-16 ページ）

## 補足

- ユーザーごとにコピー、スキャン、ファクスを集計するためには、機器のパネルでログインして、機器を使用してください。（→ 1-28 ページ）
- ユーザーごとにプリントを集計するためには、コンピューター上でプリンターの印刷設定画面を表示して、「拡張機能」タブに認証ユーザーを設定してください。設定のしかたは、『プリンター編』第 1 章の「印刷設定を変更する」の「[拡張機能] タブ」を参照してください。

## 通貨単位を設定する

料金設定の通貨単位を設定します。

- 1 〈メニュー〉を押します。
- 2 [機器設定] タブ、[機器管理] の順に押します。
- 3 管理者パスワードを設定している場合は、管理者パスワードを入力し、[確定] を押します。  
管理者パスワードを設定していない場合は、そのまま次の手順に進みます。
- 4 [ユーザー使用状況管理] を押します。

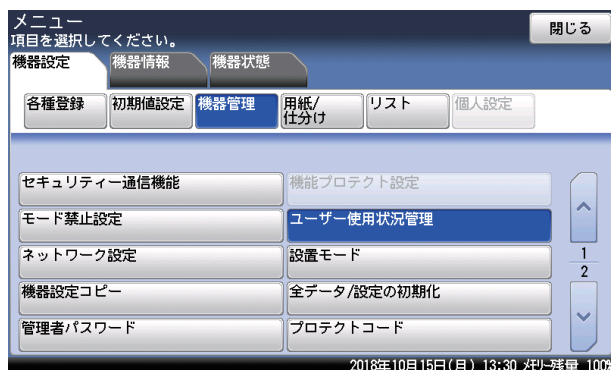

## 5 [通貨設定] を押します。

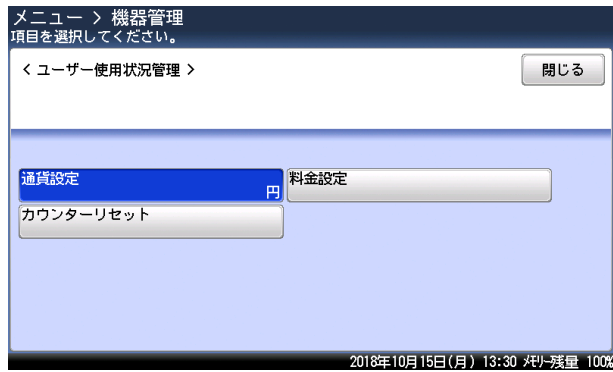

## 6 通貨単位を選択し、[確定] を押します。

# 料金を設定する

ON にしたあと、1 枚あたりの単価を設定します。

- 1 〈メニュー〉を押します。
- 2 [機器管理] を押します。
- 3 管理者パスワードを設定している場合は、管理者パスワードを入力し、[確定] を押します。  
管理者パスワードを設定していない場合は、そのまま手順 4 に進みます。
- 4 [ユーザー使用状況管理] を押します。
- 5 [料金設定] を押します。
- 6 設定したい機能を選択します。

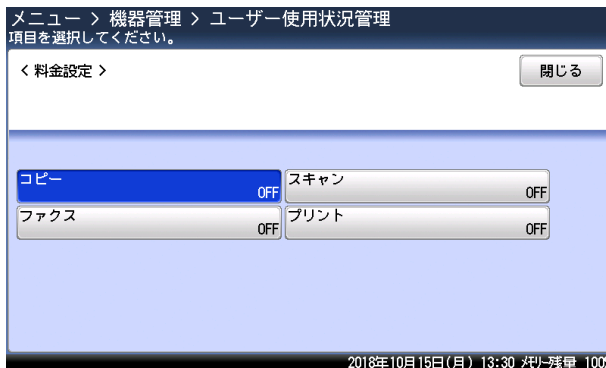

- 7 [ON] を押します。  
「OFF」を選択すると、料金設定が OFF になります。
- 8 1 枚あたりの単価を入力し、[確定] を押します。

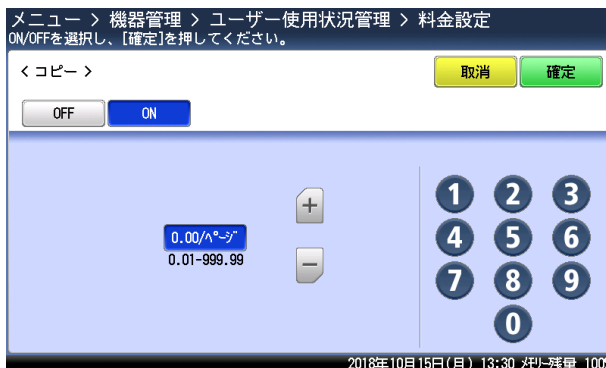

- ・続けてほかの料金設定をする場合は、手順 6 から操作を繰り返します。
- ・[+] と [-] や、テンキーを使っても設定できます

# ユーザー使用状況管理リストをプリントする

---

各モードで使用したページ数や通信時間の合計をユーザーごとにプリントできます。

ユーザー使用状況管理リストには、以下の情報が記載されています。

- コピー、ファクス、スキャン、プリントの 1 ページあたりの単価
- 全ユーザーの合計料金と総通信時間
- ゲストユーザー、一般ユーザーの総通信時間
- ゲストユーザー、一般ユーザーのファクス、スキャン、またはプリントの総ページ数と合計料金

## 補足

- インターネットファクスのページ数や通信時間はファクスの項目に加算されます。
- 料金設定が ON に設定されている項目のみ、リストにプリントされます。
- 999999 ページ、通信時間 999:59:59 (999 時間 59 分 59 秒) までカウントできます。
- 特定のユーザーの機器使用状況のみをプリントしたい場合は、『ネットワーク機能・Information server 編』第 5 章の「ユーザーの使用状況を管理する」を参照してください。

**1** 〈メニュー〉を押します。

**2** [機器設定] タブ、[リスト] の順に押します。

**3** [ユーザー使用状況管理リスト] を押します。

**4** [はい] を押します。

- 「ページ集約」を [ON] にすると、リスト 2 枚分を 1 枚の用紙に並べてプリントします。
- パンチの目印になるセンターマークをプリントできます。センターマークを付けたい位置を選択します。

# 集計データを消去する

集計したデータをすべて消去します。

- 1 〈メニュー〉を押します。
- 2 [機器設定] タブ、[機器管理] の順に押します。
- 3 管理者パスワードを設定している場合は、管理者パスワードを入力し、[確定]を押します。  
管理者パスワードを設定していない場合は、そのまま次の手順に進みます。
- 4 [ユーザー使用状況管理] を押します。
- 5 [カウンターリセット] を押します。

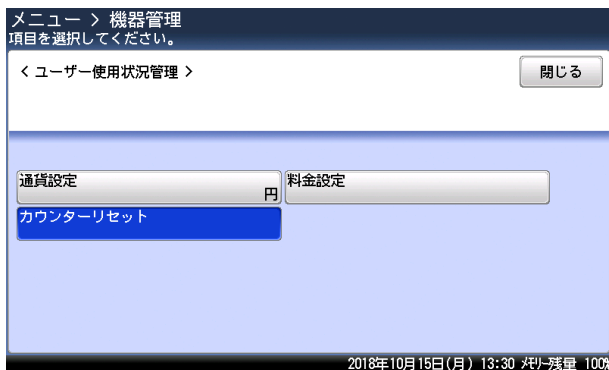

- 6 [はい] を押します。



# ネットワーク設定をする

ネットワークに関連するさまざまな機能を使用するための設定をします。

機能	機能説明	設定値	参照ページ
Ping	特定の IP アドレスを入力して Ping を実行し、接続状況を確認できます。		—
LDAP 設定 <sup>*1</sup>	LDAP サーバーを利用して、メールアドレスや名前など宛先情報を検索できます。		2-21
TCP / IP 設定	機器をネットワークで使用するための設定をします。		2-19
アーカイブ設定 <sup>*1</sup>	ファクスや電子メールで送受信した内容を、指定した宛先にファクス送信したり、指定した共有フォルダーに格納したりできます。	登録されていません	2-26
認証方法	ログインするユーザーの認証方法を設定します。	スタンドアロン シングルサインオン	2-30
アクセス制限設定のクリア	ネットワーク設定画面や Information server にアクセスできなくなった場合、アクセス制限を初期化できます。		—
スキャン to プリンターのクリア <sup>*1</sup>	スキャン to プリントモニターで登録したプリンターを、機器から削除できます。		—
サービス設定の初期化	ネットワーク設定画面や Information server にアクセスできなくなった場合、マシンポリシー設定にあるサービス設定を初期化できます。		—
ネットワーク接続速度切り替え	接続している LAN の通信速度を設定できます。	自動 100Mbps - 全二重 100Mbps - 半二重 10Mbps - 全二重 10Mbps - 半二重	—

\* 1 オプションの Information server が必要です。

## 補足

\_\_の付いている値が、工場出荷時の設定です。

- 1 <メニュー> を押します。
- 2 [機器設定] タブ、[機器管理] の順に押します。
- 3 管理者パスワードを設定している場合は、管理者パスワードを入力し、[確定] を押します。  
管理者パスワードを設定していない場合は、そのまま次の手順に進みます。
- 4 「ネットワーク設定」を選択し、[確定] を押します。
- 5 それぞれ設定を行います。

# TCP / IP 設定をする

## 補足

ネットワーク設定を変更する場合は、ネットワーク管理者に相談してください。IPアドレスの設定を間違えると、正しくネットワークに接続できません。

項目	説明
ホスト名	機器のホスト名を入力します。15文字まで入力できます。 名前の先頭に「*」は、入力できません。 初期値はMACアドレスです。
ワークグループ名	機器が接続されているネットワークのワークグループ名を入力します。 15文字まで入力できます。名前の先頭に「*」は、入力できません。 初期値は「WORKGROUP」です。 <b>補足</b> <ul style="list-style-type: none"><li>・ドメイン名はワークグループ名として使用できません。</li><li>・ネットワーク上にワークグループが無い場合は、新しいワークグループを作成してください。</li><li>・新しいワークグループを作成する場合は、ネットワーク管理者にお問い合わせください。</li></ul>
DNS サーバーアドレス	DNS サーバーを使用しているときは、優先 DNS サーバーアドレス（優先プライマリー）、代替 DNS サーバーアドレス（セカンダリー）を入力します。
DNS サフィクス	ホスト名だけで名前解決をする場合は、DNS サフィクスを登録します。 50文字まで入力できます。
IP アドレス自動取得	ネットワーク上に DHCP サーバーがある場合に、DHCP サーバーから自動的に IP アドレスを取得するかどうかを設定します。IP アドレスを自動で取得する場合は「ON」、自動で取得しない場合は「OFF」を設定します。 初期値は「ON」です。
IP アドレス	機器のネットワーク上の IP アドレスを設定します。 初期値は「192.168.1.10」です。 0.0.0.0、255.255.255、127. から始まるアドレスの入力はできません。 <b>補足</b> <p>「IP アドレス自動取得」が ON のときは、設定できません。</p>
サブネットマスク	サブネットマスクを設定します。 0.0.0.0、255.255.255、127. から始まるアドレスの入力はできません。 初期値は「255.255.255.0」です。 <b>補足</b> <p>「IP アドレス自動取得」が ON のときは、設定できません。</p>
ゲートウェイアドレス	ゲートウェイを使用しているときは、ゲートウェイアドレスを設定します。 0.0.0.0、255.255.255、127. から始まるアドレスの入力はできません。
WINS サーバーアドレス	WINS サーバーを使用しているときは、WINS サーバーアドレスを入力します。 0.0.0.0、255.255.255、127. から始まるアドレスの入力はできません。

項目	説明
IPv6 設定	<p>以下の設定ができます。</p> <ul style="list-style-type: none"> <li>• IPv6 アドレスを自動取得</li> <li>• グローバル IP アドレス</li> <li>• サブネットプレフィクス</li> <li>• ゲートウェイアドレス</li> </ul> <p>以下の確認ができます。</p> <ul style="list-style-type: none"> <li>• リンクローカルアドレス</li> </ul> <p>IPv6 設定の詳細は、『ネットワーク機能・Information server 編』第4章の「ネットワーク環境を設定する (TCP/IP 設定)」を参照してください。</p>

- 1 <メニュー> を押します。
- 2 [機器設定] タブ、[機器管理] の順に押します。
- 3 管理者パスワードを設定している場合は、管理者パスワードを入力し、[確定] を押します。  
管理者パスワードを設定していない場合は、そのまま次の手順に進みます。
- 4 [ネットワーク設定] を押します。
- 5 [TCP / IP 設定] を押します。

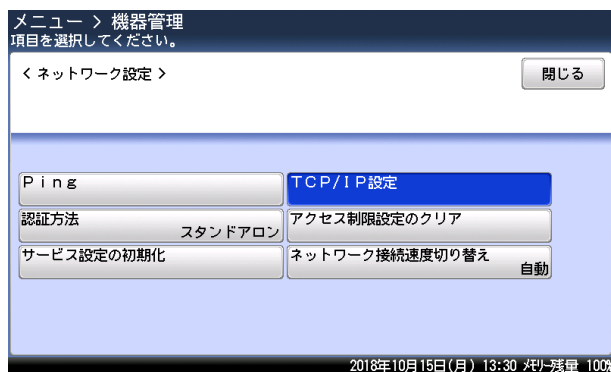

- 6 それぞれ設定を行います。

# LDAP サーバーを登録する

LDAP サーバーを利用して、メールアドレスや名前など宛先情報を検索できます。  
以下の情報が登録できます。

## 補足

オプションの Information server が必要です。

項目	説明
名前	画面に表示されるボタン名称です。半角 23 文字まで入力できます。 登録しなかった場合は、LDAP サーバーアドレスの先頭から 23 文字までが表示されます。
LDAP サーバーアドレス	登録する LDAP サーバーの名前、または IP アドレスを入力します。99 文字まで入力できます。
ポート番号	LDAP サーバーのポート番号を入力します。 設定可能範囲は 0 ~ 65535 で、初期値は 389 です。
認証方式	LDAP サーバーのアクセスにログインが必要かどうかを設定します。
ls ユーザーログイン	「認証方式」で「Simple」か「DIGETS-MD5」を選択した場合、ログインに Information server のユーザー情報を使用するかどうか設定にします。 この設定を有効にするときは、Information server のユーザー登録で「LDAP サーバー認証」のアカウントとパスワードを登録しておく、検索のたびにアカウントとパスワードを入力する必要があります。
アカウント ID	「ls ユーザーログイン」で「OFF」を選択した場合に、ログインに使用するアカウント ID を登録します。 アカウントを登録しないと、検索のときにアカウントの入力が必要になります。49 文字まで入力できます。
パスワード	「ls ユーザーログイン」で「OFF」を選択した場合に、ログインに使用するパスワードを登録します。 パスワードを登録しないと、検索のときにパスワードの入力が必要になります。29 文字まで入力できます。
検索開始位置	LDAP サーバーの検索開始位置を入力します。99 文字まで入力できます。
検索結果最大件数	検索結果を何件まで表示するか設定します。検索結果が設定した件数より多かった場合は、エラーを表示します。設定可能範囲は 1 ~ 100 件で、初期値は 50 件です。
最大検索時間	検索結果を表示するまでにかかる時間の上限を設定します。検索結果が設定した時間より長くかかった場合は、エラーを表示します。設定可能範囲は 0 ~ 9999 秒で、あらかじめ設定されている値は、0 (制限なし) です。
オプション設定	パラメーターに検索条件を追加できます。
追加する属性	追加する検索条件の属性を入力します。49 文字まで入力できます。
追加する値	追加する検索条件の値を入力します。99 文字まで入力できます。
検索方法	検索方法を選択します。

項目	説明
検索属性設定	
名前 1	名前の属性を設定します。49 文字まで入力できます。初期値は「cn」です。
名前 2	名前の属性を設定します。49 文字まで入力できます。初期値は「commonname」です。
メールアドレス 1	メールアドレスの属性を設定します。49 文字まで入力できます。初期値は「mail」です。
メールアドレス 2	メールアドレスの属性を設定します。49 文字まで入力できます。
ファクス番号 1	ファクス番号の属性を設定します。49 文字まで入力できます。初期値は「facsimileTelephoneNumber」です。
ファクス番号 2	ファクス番号の属性を設定します。49 文字まで入力できます。
電話番号 1	電話番号の属性を設定します。49 文字まで入力できます。初期値は「telephoneNumber」です。
電話番号 2	電話番号の属性を設定します。49 文字まで入力できます。
会社名 1	会社名の属性を設定します。49 文字まで入力できます。初期値は「company」です。
会社名 2	会社名の属性を設定します。49 文字まで入力できます。初期値は「O」です。

## □ LDAP サーバーを登録する・変更する

LDAP サーバーは 5 つまで登録できます。

ここでは LDAP サーバーの登録方法を説明します。変更の場合は、手順 6 で変更したい LDAP サーバーを選択し、[変更] を押します。手順 6 の画面が表示されるので、変更したい項目を選択して変更してください。

### 補足

1 つ目の LDAP サーバーを登録した場合は、「優先サーバーに設定しました。」というメッセージが表示されます。

- 1 <メニュー> を押します。
- 2 [機器設定] タブ、[機器管理] の順に押します。
- 3 管理者パスワードを設定している場合は、管理者パスワードを入力し、[確定] を押します。  
管理者パスワードを設定していない場合は、そのまま次の手順に進みます。
- 4 [ネットワーク設定] を押します。

## 5 [LDAP 設定] を押します。

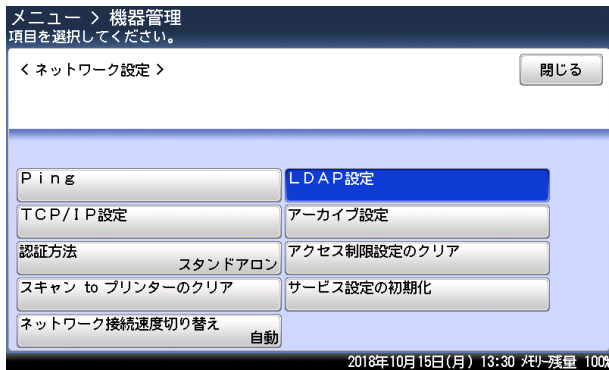

## 6 [登録] を押します。

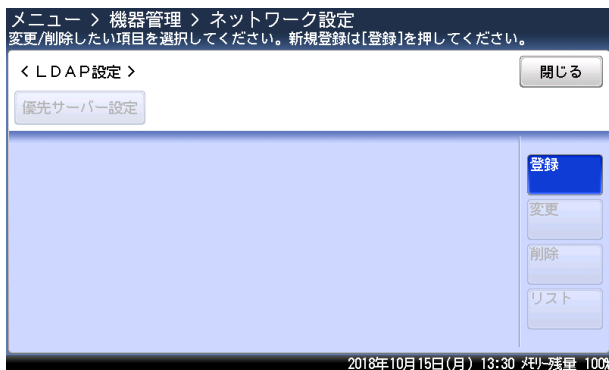

## 7 それぞれの項目を登録します。

## □ 優先 LDAP サーバーを設定する

登録されている LDAP サーバーの中から、LDAP 検索するとき使用する LDAP サーバーを設定します。

あらかじめ 1 つ以上の LDAP サーバーを登録しておいてください。

- 1 〈メニュー〉を押します。
- 2 [機器設定] タブ、[機器管理] の順に押します。
- 3 管理者パスワードを設定している場合は、管理者パスワードを入力し、[確定]を押します。  
管理者パスワードを設定していない場合は、そのまま次の手順に進みます。
- 4 [ネットワーク設定] を押します。
- 5 [LDAP 設定] を押します。
- 6 [優先サーバー設定] を押します。

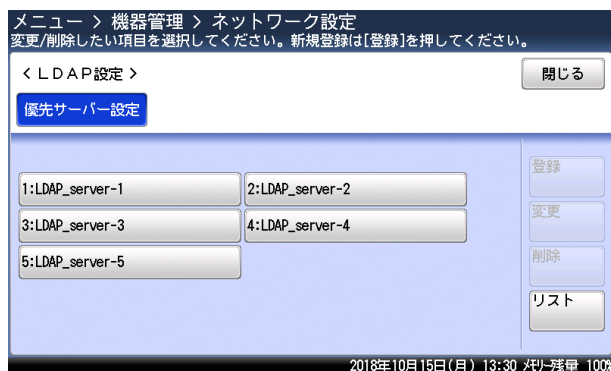

- 7 優先サーバーに設定したい LDAP サーバーを選択し、[確定] を押します。

## LDAP サーバーを削除する

---

- 1 〈メニュー〉を押します。
- 2 [機器設定] タブ、[機器管理] の順に押します。
- 3 管理者パスワードを設定している場合は、管理者パスワードを入力し、[確定] を押します。  
管理者パスワードを設定していない場合は、そのまま次の手順に進みます。
- 4 [ネットワーク設定] を押します。
- 5 [LDAP 設定] を押します。
- 6 削除したい LDAP サーバーを選択し、[削除] を押します。
- 7 [はい] を押します。

## LDAP 設定リストをプリントする

---

### 補足

〈メニュー〉→[機器設定] タブ→[リスト]→[LDAP 設定リスト]からもプリントできます。  
手順 7 から続けてください。

- 1 〈メニュー〉を押します。
- 2 [機器設定] タブ、[機器管理] の順に押します。
- 3 管理者パスワードを設定している場合は、管理者パスワードを入力し、[確定] を押します。  
管理者パスワードを設定していない場合は、そのまま次の手順に進みます。
- 4 [ネットワーク設定] を押します。
- 5 [LDAP 設定] を押します。
- 6 [リスト] を押します。
- 7 [はい] を押します。
  - 「ページ集約」を [ON] にすると、リスト 2 枚分を 1 枚の用紙に並べてプリントします。
  - パンチの目印になるセンターマークをプリントできます。センターマークを付けたい位置を選択します。



# アーカイブ設定をする

---

ファクス送受信した文書の内容を、指定した宛先にファクス送信できます。これを「アーカイブ」といいます。それぞれ設定できるアーカイブ先は1つです。

## ■アーカイブできる通信の種類

- ・送信済みファクス
- ・送信済みインターネットファクス
- ・送信済み電子メール
- ・受信済みファクス
- ・受信済みインターネットファクス

## ■アーカイブできない通信の種類

- ・ポーリング送信
- ・ポーリング受信
- ・Fコードポーリング送信
- ・Fコードポーリング受信
- ・Fコード親展受信
- ・Fコード掲示板受信

## ■格納先（いずれか1つ）

- ・ファクス宛先
- ・共有フォルダー

## 📌補足

- ・オプションの Information server が必要です。
- ・アーカイブ設定が ON の場合、リアルタイム送信および手動送信（ハンドセットや [オンフック] を使った送信）はできません。
- ・送信済み電子メールは、ファクス宛先にはアーカイブできません。
- ・送受信が正常に行われた場合のみ、設定したデータ保存が行われます。エラーなどで正常に送受信されなかった場合は、設定したデータ保存は行われません。
- ・アーカイブに失敗するとチェックメッセージがプリントされます。ユーザーが送信したファクスやインターネットファクスの送受信の失敗ではありません。

## □ アーカイブ先を設定する

ここでは、送信済みファクスのアーカイブ先設定を例に説明します。

- 1 <メニュー> を押します。
- 2 [機器設定] タブ、[機器管理] の順に押します。
- 3 管理者パスワードを設定している場合は、管理者パスワードを入力し、[確定] を押します。  
管理者パスワードを設定していない場合は、そのまま次の手順に進みます。
- 4 [ネットワーク設定] を押します。

## 5 [アーカイブ設定] を押します。

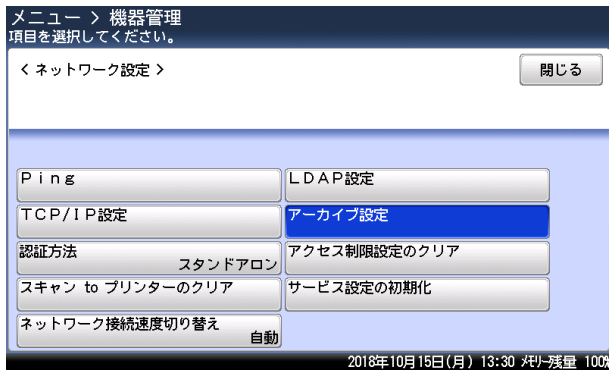

## 6 設定したい項目を選択します。

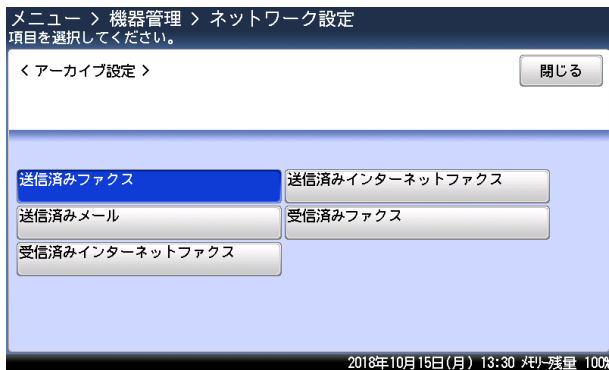

ここでは、[送信済みファクス] を押します。

## 7 [設定] を押します。

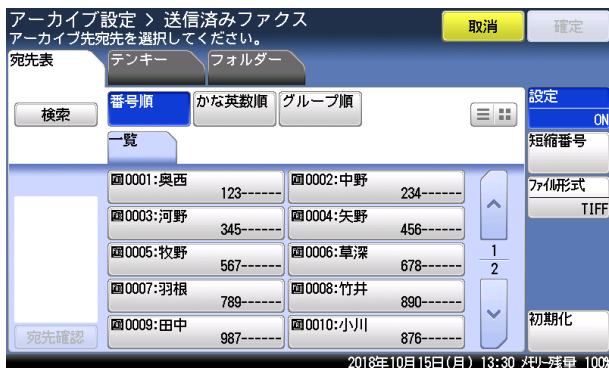

[設定] を押すごとに ON と OFF が切り替わります。

## 8 アーカイブ先のファクス番号またはフォルダーを設定します。

- ・ファクス番号を宛先に設定する方法は、『スキャナー・ファクス編』第6章の「宛先を指定する」を参照してください。
- ・フォルダーを設定する場合は、フォルダーショートカットを選択する方法とフォルダーのリンク先を入力する方法があります。詳細については『スキャナー・ファクス編』第1章の「スキャンしたファイルを送信する」の「共有フォルダーに保存する (スキャン to フォルダー)」を参照してください。

## 9 [ファイル形式] を押します。

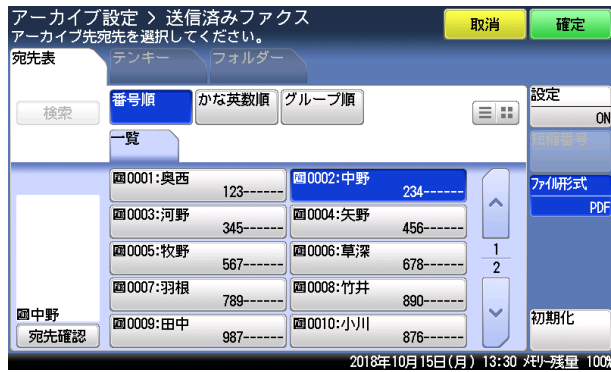

- ・[ファイル形式] を押すたびに、ファイル形式が TIFF と PDF で切り替わります。
- ・アーカイブ先にファクス番号を選択したときは、この手順は不要です。

## 10 [確定] を押します。

- ・手順はこれで終了です。
- ・続けて操作する場合は、手順 6 から操作を繰り返します。

## □ アーカイブ設定を初期化する

- 1 〈メニュー〉を押します。
- 2 [機器設定] タブ、[機器管理] の順に押します。
- 3 管理者パスワードを設定している場合は、管理者パスワードを入力し、[確定]を押します。  
管理者パスワードを設定していない場合は、そのまま次の手順に進みます。
- 4 [ネットワーク設定] を押します。
- 5 [アーカイブ設定] を押します。
- 6 アーカイブ設定を初期化したい項目を選択します。
- 7 [初期化] を押します。

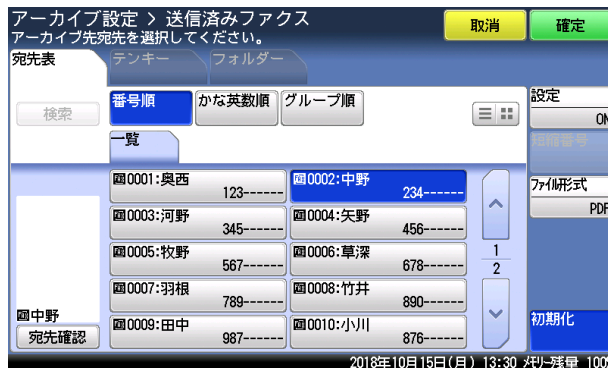

- 8 初期化する場合は [はい] を押します。

# ユーザー認証方法を設定する

この機能は使用するユーザーの認証方法を設定して、機器の使用を制限できます。

認証方法は2種類あります。

認証方法	説明
スタンドアロン	機器の中のユーザー情報を使って、ユーザー認証を行います。 あらかじめ、ユーザー情報を登録しておく必要があります。
シングルサインオン	Active Directory の認証を行ったあと、機器の中のユーザー情報を使ってユーザー認証を行います。 該当するユーザー情報が登録されていない場合は、自動的にユーザー情報を新規登録します。また、該当するユーザー情報がすでに登録されている場合は、Active Directory に登録されている情報で上書きします。

## 補足

- 登録ユーザー数が上限(200件)を超えた場合は、「シングルサインオン」設定時でもユーザー登録はされず、ゲストユーザーとしてログインします。
- ユーザー認証を「シングルサインオン」に設定するときは、あらかじめドメイン名の登録が必要です。ドメイン名は、ネットワーク設定または Information server の「マシンポリシー」画面から登録してください。詳細は、『ネットワーク機能・Information server 編』第5章の「セキュリティーを設定する」の「マシンポリシーを設定する」を参照してください。

- 1 <メニュー> を押します。
- 2 [機器設定] タブ、[機器管理] の順に押します。
- 3 管理者パスワードを設定している場合は、管理者パスワードを入力し、[確定] を押します。  
管理者パスワードを設定していない場合は、そのまま次の手順に進みます。
- 4 [ネットワーク設定] を押します。
- 5 [認証方法] を押します。

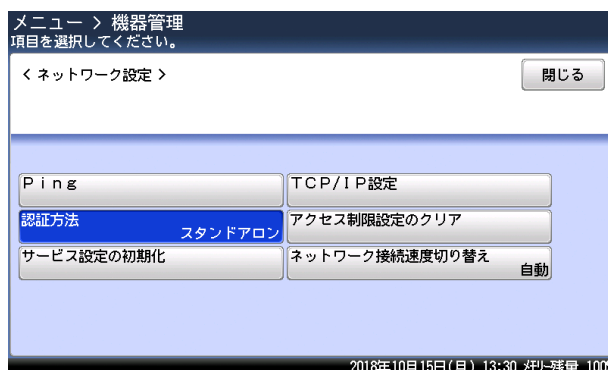

- 6 認証方法を選択し、[確定] を押します。
- 7 [はい] を押します。

# 機器設定をコピーする

コピー設定、ファクス設定や宛先表の登録内容などの機器設定データを同機種のほかの機器へコピーできます。

複数台の機器で機器設定を同じにしたい場合などに便利です。

USB メモリーに機器設定データをエクスポートし、ほかの機器へインポートします。

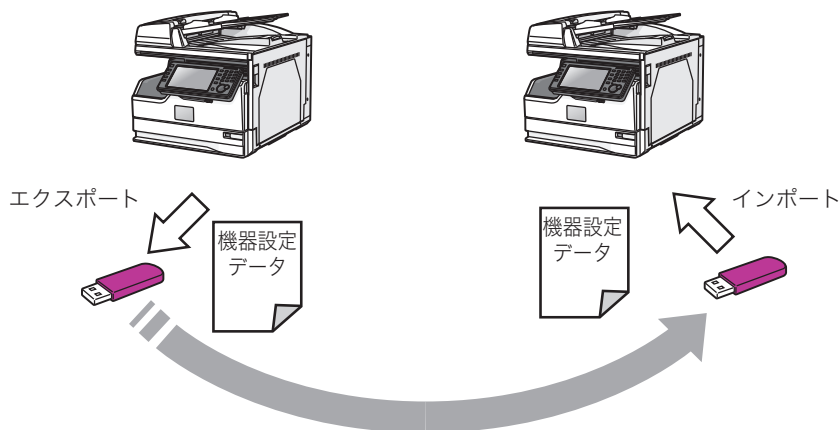

## USB メモリーにエクスポートする

### 補足

- FAT12、FAT16、または FAT32 でフォーマットした USB メモリーが使用できます。
- セキュリティ機能付の USB メモリーや、USB 接続のメモリーカードリーダー、延長ケーブルや USB ハブ経由での USB メモリー、USB の規格に準拠していない USB メモリーはサポートしていません。
- 途中で USB メモリーの容量が不足した場合は、書き込み中のデータがすべて削除されます。あらかじめ USB メモリーの容量が十分あることを確認してください。

### 1 <メニュー> を押します。

誤って USB メモリーを接続した場合は、「USB メモリーが接続されました」と表示されます。[閉じる] を押して画面を閉じます。

### 2 [機器設定] タブ、[機器管理] の順に押します。

### 3 管理者パスワードを設定している場合は、管理者パスワードを入力し、[確定] を押します。

管理者パスワードを設定していない場合は、そのまま次の手順に進みます。

#### 4 [機器設定コピー] を押します。

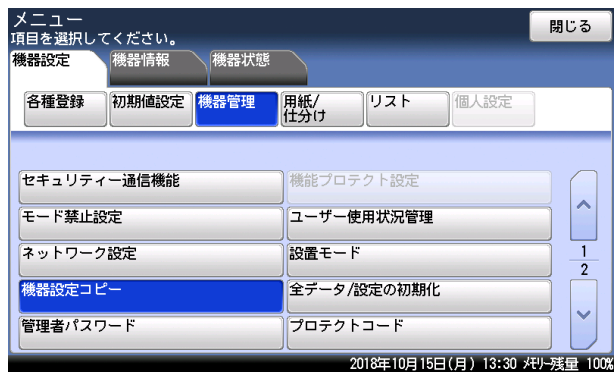

#### 5 エクスポートする機器の USB メモリー接続端子に、USB メモリーを接続します。

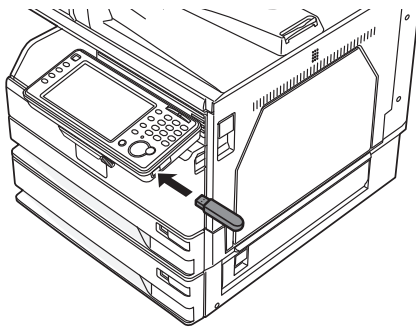

#### 6 [USB エクスポート] を押します。



## 7 機器設定データを保存するフォルダーを指定し、[確定] を押します。

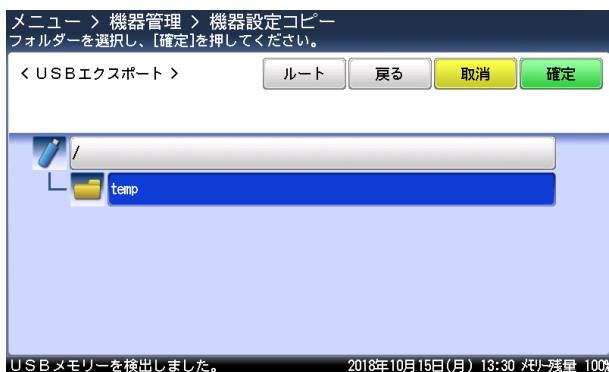

[ルート] をクリックすると、一番先頭の階層 (ルート) に戻ります。

## 8 ファイル名を入力し、[確定] を押します。

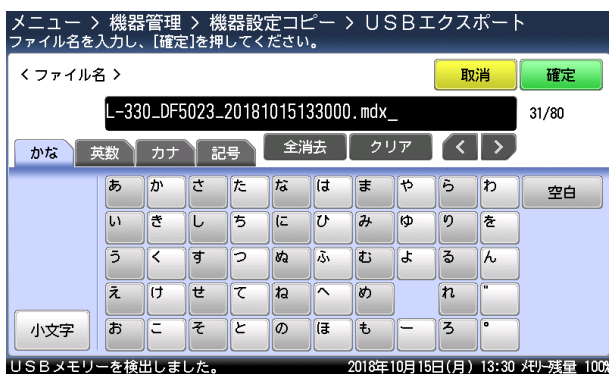

- ・初期ファイル名は、「製品名称\_機台番号\_日時 (YYYYMMDDhhmmss) .mdx」です。
- ・ファイル名の最後には「.mdx」を必ず付けてください。
- ・半角 80 文字まで入力できます。

## 9 パスワードを設定する場合は、パスワードを入力し、[確定] を押します。

- ・パスワードを設定しないときは、何も入力せずに [確定] を押します。
- ・半角 28 文字まで入力できます。

## 10 [はい] を押します。

## 11 エクスポートが完了したら、[閉じる] を押して、USB メモリーを機器から抜き取ります。

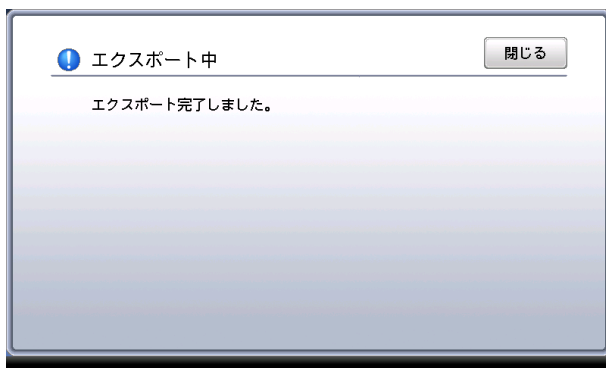



# USB メモリーから機器にインポートする

- 1 <メニュー> を押します。  
誤って USB メモリーを接続した場合は、「USB メモリーが接続されました」と表示されます。  
[閉じる] を押して画面を閉じます。
- 2 [機器設定] タブ、[機器管理] の順に押します。
- 3 管理者パスワードを設定している場合は、管理者パスワードを入力し、[確定] を押します。  
管理者パスワードを設定していない場合は、そのまま次の手順に進みます。
- 4 [機器設定コピー] を押します。
- 5 インポート先の機器の USB メモリー接続端子に、機器設定データの入った USB メモリーを接続します。

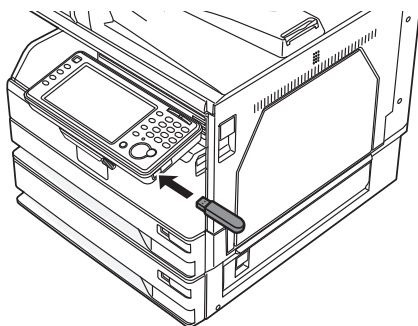

- 6 [USB インポート] を押します。
- 7 インポートする機器設定データを選択し、[確定] を押します。



- ・[ルート] をクリックすると、一番先頭の階層（ルート）に戻ります。
- ・ を押すと、ファイル情報（文書名、場所、ファイルサイズ、最終更新日）を表示します。

- 8 パスワードを入力し、[確定] を押します。  
パスワードが設定されていないときは、何も入力せずに [確定] を押します。
- 9 機器設定のみインポートする場合は [機器設定のみ] を、すべてのデータをインポートする場合は [すべて] を選択し、[はい] を押します。

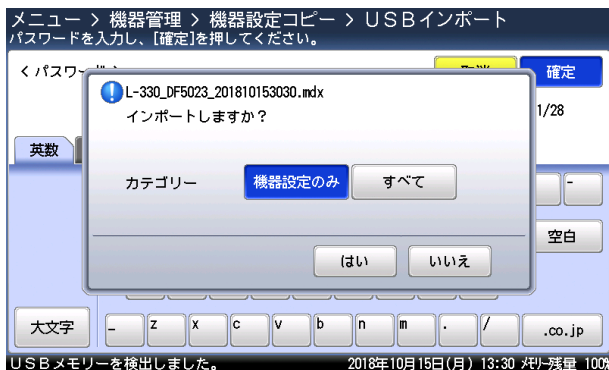

- [機器設定のみ] を選択した場合はユーザー情報が消去され、[すべて] を選択した場合はインポートしたユーザー情報で上書きされます。
- [機器設定のみ] を選択した場合と [すべて] を選択した場合のインポートされる設定データの違いについては、補足を参照してください。(→ 2-36 ページ)

- 10 インポートが完了したら、[閉じる] を押して、USB メモリーを機器から抜き取ります。

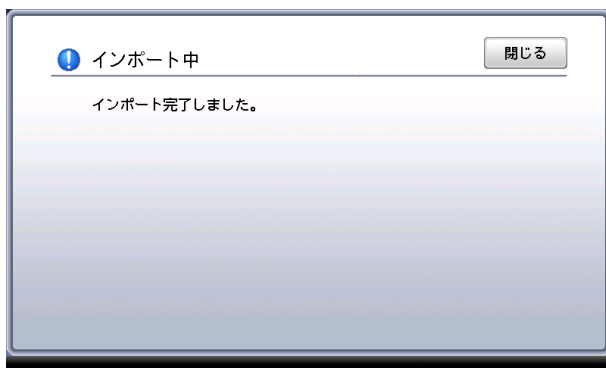

機器情報がインポートされると、機器は自動的に再起動を行います。

補足

[機器設定のみ] と [すべて] のインポート範囲は以下のとおりです。

項目	機器設定のみ	すべて
機器の設定	機器に保存されている全データ	機器に保存されている全データ
ユーザー情報	<ul style="list-style-type: none"> <li>宛先表 (共有)</li> <li>ショートカット (共有) <sup>1</sup></li> <li>テンプレート設定 <sup>1 2</sup></li> </ul>	<ul style="list-style-type: none"> <li>宛先表 (共有)</li> <li>ショートカット (共有) <sup>1</sup></li> <li>テンプレート設定 <sup>1 2</sup></li> <li>ユーザー登録</li> <li>宛先表 (個人)</li> <li>ショートカット (個人)</li> <li>ユーザーボックス転送設定 <sup>1</sup></li> </ul>
機器設定	<ul style="list-style-type: none"> <li>LDAP 設定</li> <li>SNMP 設定</li> <li>本体機器設定</li> <li>本体初期値設定</li> <li>TCP/IP 設定 <sup>3</sup></li> <li>メール設定 <sup>1 4</sup></li> <li>インターネット時刻設定 <sup>1 5</sup></li> </ul>	<ul style="list-style-type: none"> <li>LDAP 設定</li> <li>SNMP 設定</li> <li>本体機器設定</li> <li>本体初期値設定</li> <li>TCP/IP 設定 <sup>3</sup></li> <li>メール設定 <sup>1 4</sup></li> <li>インターネット時刻設定 <sup>1 5</sup></li> </ul>
機器管理設定	<ul style="list-style-type: none"> <li>アクセス制限 <sup>1</sup></li> <li>文書ボックス設定 <sup>1</sup></li> <li>ユーザー使用状況管理 <sup>6</sup></li> <li>セキュリティー設定 <sup>7</sup></li> </ul>	<ul style="list-style-type: none"> <li>アクセス制限 <sup>1</sup></li> <li>文書ボックス設定 <sup>1</sup></li> <li>ユーザー使用状況管理 <sup>6</sup></li> <li>セキュリティー設定 <sup>7</sup></li> <li>自動配信</li> <li>ユーザーポリシー</li> </ul>
機器情報	機器状態の機器名称、設置場所	機器状態の機器名称、設置場所

- \* 1 オプションの Information server が必要です。
- \* 2 ただし、カバーページはインポートされません。
- \* 3 ホスト名、IP アドレスは対象外。
- \* 4 機器情報の名前、機器メールアドレス、返信先メールアドレス、SMTP 認証ユーザー名、SMTP 認証パスワード、POP3 ユーザー名、認証方式は対象外。
- \* 5 同期時刻、前回同期時刻は対象外。
- \* 6 各機能でカウントされた時間やページ数などのデータは対象外。
- \* 7 SSL 証明書設定は対象外。

# 自動ログアウト時間を設定する

ログイン後、何も操作しなかった場合に自動的にログアウトするまでの時間を設定します。ユーザー認証を受けた（ログインした）状態で機器から離れてしまったときに、不正に使用されるのを防ぎます。

設定可能範囲は1～10分で、初期値は3分です。

## 補足

手動でログアウトする方法については、「[ログアウトする](#)」(1-29 ページ) を参照してください。

- 1 〈メニュー〉を押します。
- 2 [機器設定] タブ、[機器管理] の順に押します。
- 3 管理者パスワードを設定している場合は、管理者パスワードを入力し、[確定] を押します。  
管理者パスワードを設定していない場合は、そのまま次の手順に進みます。
- 4 「自動ログアウト時間」を押します。

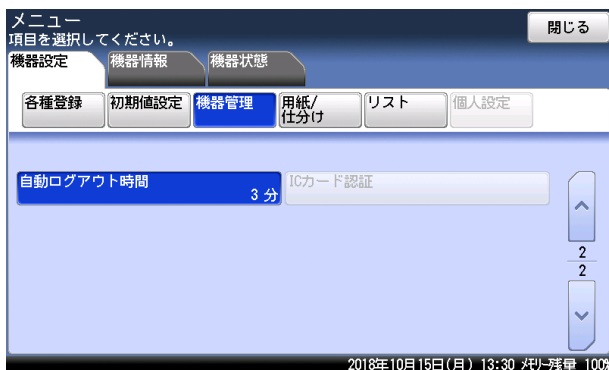

- 5 自動ログアウト時間を入力し、[確定] を押します。  
[+] と [-] や、テンキーを使って設定できます

# IC カード認証を設定する

オプションの IC カード認証装置が装着されている場合は、カード認証の設定をしてください。

## 補足

- IC カード認証装置はオプションです。
- IC カードは、FeliCa と MIFARE が使用できます。
- あらかじめ管理者パスワードの設定が必要です。(→ 2-4 ページ)

## IC カード認証を有効にする

- 1 <メニュー> を押します。
- 2 [機器設定] タブ、[機器管理] の順に押します。
- 3 管理者パスワードを入力し、[確定] を押します。
- 4 [IC カード認証] を押します。

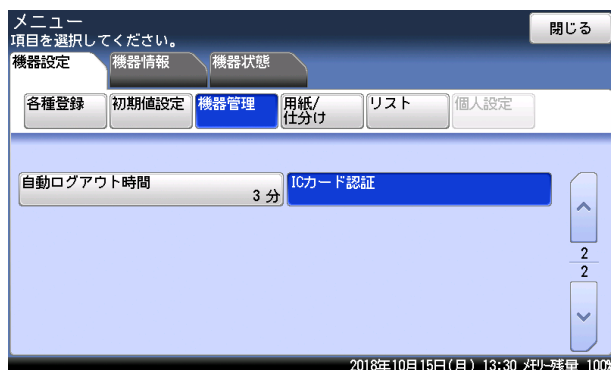

- 5 [設定] を選択します。

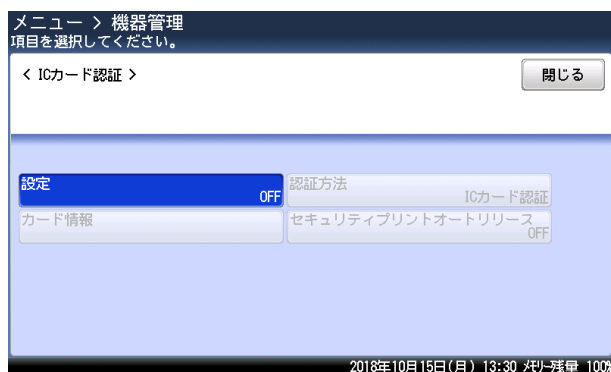

- 6 [ON] を選択し、[確定] を押します。  
[OFF] を選択すると、IC カード認証機能が無効になります。

# 認証方法を設定する

IC カードをかざしたときの認証方法を次の 2 つから選択できます。

- IC カード認証 : IC カードを読み取り部にかざすと、ユーザーが認証され、ログインされます。
- IC カード認証 + パスワード : IC カードを読み取り部にかざすとユーザー名が認識され、パスワードが設定されている場合は、パスワードの入力画面が表示されます。パスワードを入力するとログインされます。
- IC カードのみでログイン : この機能を ON にすると、IC カード以外でのログインを禁止します (ログイン画面でユーザーのボタンが押せなくなります)。

- 1 <メニュー> を押します。
- 2 [機器設定] タブ、[機器管理] の順に押します。
- 3 管理者パスワードを入力し、[確定] を押します。
- 4 [IC カード認証] を押します。
- 5 [認証方法] を選択します。

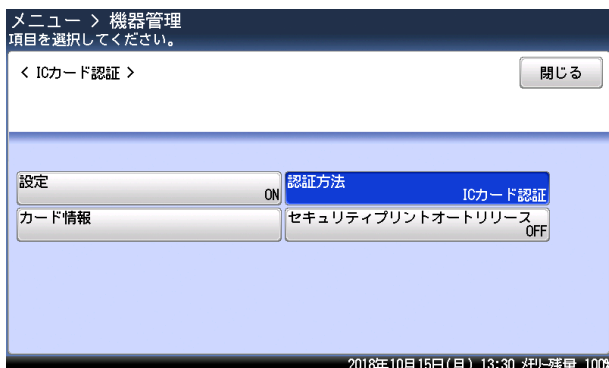

- 6 認証方法を選択し、[確定] を押します。

# IC カード情報を登録する

ユーザーごとに IC カードの情報を登録してください。一人のユーザーにつき、登録できる IC カードは 1 枚だけです。

## □ IC カード情報を新規登録する

- 1 <メニュー> を押します。
- 2 [機器設定] タブ、[機器管理] の順に押します。
- 3 管理者パスワードを入力し、[確定] を押します。
- 4 [IC カード認証] を押します。
- 5 [カード情報] を選択します。

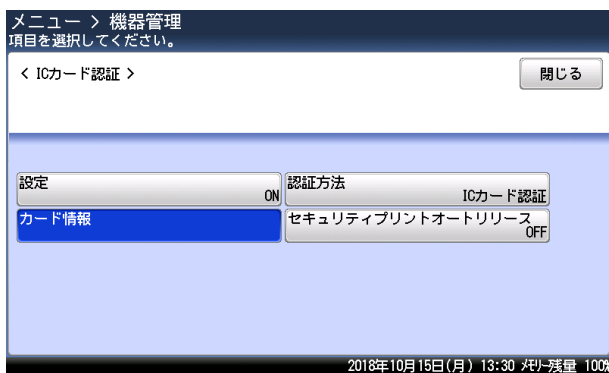

- 6 [登録] を選択します。
- 7 登録するユーザーを選択します。

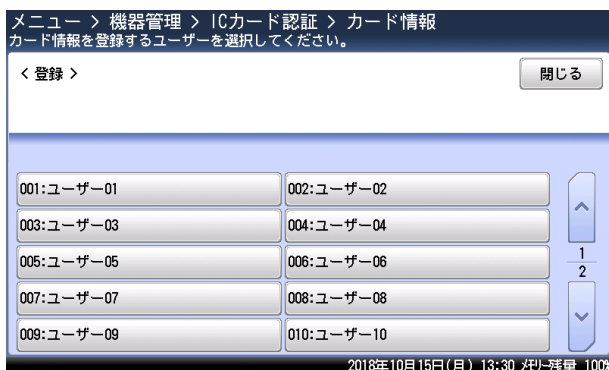

## 8 登録する IC カードを読み取り部にかざします。

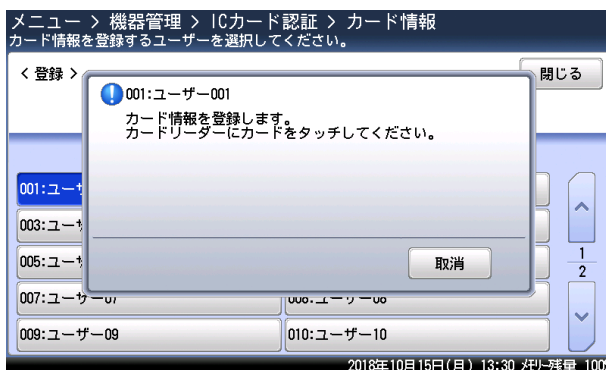

- ・読み取りが完了すると、「登録完了しました」と表示してから画面が閉じられます。
- ・手順7から繰り返して、すべてのユーザーの IC カードを登録します。

## □ IC カード情報を変更する

登録した IC カード情報を変更できます。

- 1 〈メニュー〉を押します。
- 2 [機器設定] タブ、[機器管理] の順に押します。
- 3 管理者パスワードを入力し、[確定] を押します。
- 4 [IC カード認証] を押します。
- 5 [カード情報] を選択します。
- 6 [変更] を選択します。
- 7 IC カード情報を変更するユーザーを選択します。
- 8 新しく登録する IC カードを読み取り部にかざします。

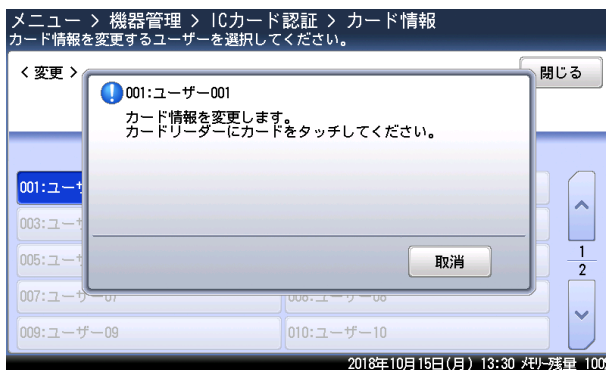

読み取りが完了すると、「変更完了しました。」と表示してから画面が閉じられます。



## □ IC カード情報を削除する

登録した IC カード情報を削除できます。ユーザーごとに削除を行う「削除」とすべてのユーザーの情報をまとめて削除する「全削除」があります。

- 1 〈メニュー〉を押します。
- 2 [機器設定] タブ、[機器管理] の順に押します。
- 3 管理者パスワードを入力し、[確定] を押します。
- 4 [IC カード認証] を押します。
- 5 [カード情報] を選択します。
- 6 [削除] を選択します。
- 7 ユーザーごとに削除を行う場合は [削除]、すべてのユーザーの情報をまとめて削除する場合は [全削除] を選択します。  
[全削除] を選択した場合は、手順 9 に進みます。
- 8 [削除] を選択した場合は、IC カード情報を削除するユーザーを選択します。
- 9 [はい] を選択します。  
[いいえ] を選択すると、削除をキャンセルします。

## セキュリティプリントのオートリリース機能を設定する

---

この機能を有効にすると、ユーザーが IC カードを使ってログインしたときに、セキュリティプリント文書のデータが蓄積されていた場合、文書をプリントする画面が表示されます。

- 1 〈メニュー〉を押します。
- 2 [機器設定] タブ、[機器管理] の順に押します。
- 3 管理者パスワードを入力し、[確定] を押します。
- 4 [IC カード認証] を押します。
- 5 [セキュリティプリントオートリリース] を選択します。
- 6 [ON] を選択し、[確定] を押します。  
[OFF] を選択すると、セキュリティプリントのオートリリース機能が無効になります。

# 第 3 章

## 主な仕様

---

主な仕様.....	3-2
主な仕様.....	3-2
外形寸法.....	3-10

# 主な仕様

本商品の仕様、外観は改良のため予告なく変更することがあります。あらかじめご了承ください。

## 主な仕様

### □ 基本仕様／コピー仕様

項目		仕 様
名称		L-330
形式		卓上型
メモリー容量		ファクス：32MB、コピー：58MB
読み取り解像度		600 dpi × 600 dpi
書き込み解像度		600 dpi × 600 dpi
階調		256 階調
感光体種類		OPC ドラム
複写方式		LED を露光光源とする乾式電子写真方式
現像方式		非磁性 1 成分接触現像
定着方式		ヒートローラーによる熱圧力定着方式
原稿サイズ		シート： 最大 297 mm × 420 mm
複写サイズ	用紙サイズ	給紙カセット 1 A4、A4☑、B5☑、A5☑、16K、16K☑、Letter、Letter☑ 給紙カセット 2 (オプション) B4、A4、A4☑、A5☑、B5☑、16K、16K☑、Letter、 Letter☑、Legal、Legal 13、F4
	画像欠け幅	先端・後端 3 mm、左・右 3 mm
用紙種類		普通紙、再生紙 60 ~ 90 g/m <sup>2</sup> 、約 300 枚 (64 g/m <sup>2</sup> )
ウォームアップタイム		27.0 秒 (室温 23 °C) キー操作受付までの時間：約 13 秒
連続複写速度 (最大) <sup>*2</sup>		A4☑ : 18.1 枚/分 A4 : 18.3 枚/分 B4 <sup>*3</sup> : 18.4 枚/分 B5☑ : 18.5 枚/分
複写倍率	固定	等倍 100 % ± 1.5 % 以内 拡大 141 % / 122 % / 115 % 縮小 86 % / 81 % / 70 %
	ズーム	25 ~ 400 % (1 % きざみ)
給紙方式	標準	給紙カセット (300 枚) × 1 段 64 g/m <sup>2</sup>
	オプション (最大)	給紙カセット (300 枚) × 1 段 64 g/m <sup>2</sup>
連続複写枚数		1 ~ 999 枚
電源		AC 100 ± 10 V 50/60 Hz 共用
待機電力		待機時 : 58 Wh 節電モード (モード 1) : 14 W 節電モード (モード 2) : 0.5 W (最小電力モード時 : 0.19 W <sup>*4</sup> )
最大消費電力 <sup>*5</sup>		880 W 以下 (フルオプション時)
電流値		9.1 A

項目	仕様
直流抵抗値	360.0 Ω (オプションのハンドセット装着時)
大きさ (幅×奥×高)	幅 500 mm × 奥行き 585 mm(※) × 高さ 460mm (※パネル角度 85° のとき)
機械占有寸法 (幅×奥)	幅 562 mm × 奥行き 631 mm (パネル角度 24°、延長用紙トレイを引き出した状態。突起部を除く)
質量 <sup>*6</sup>	約 25.6 kg
環境条件	周囲温度が 10 °C以上 30 °C以下のとき 相対湿度：20～80 % 周囲温度が 30 °Cを超えて 32 °C以下のとき 相対湿度：20～68 %

- \* 1 用紙サイズは、縦と横の比率が 2.5 倍以内に収まるように設定してください。
- \* 2 連続複写速度は、使用条件により低下する場合があります。
- \* 3 オプションの増設給紙カセットが必要です。
- \* 4 オプションの Information server、または IC カード認証装置の装着時は、設定できません。
- \* 5 最大消費電力の数値は、起動時や定着ヒーター通電時の瞬間的ピークの消費電力ではありません。
- \* 6 消耗品を除いた重さです。

## □ 自動原稿送り装置仕様

項目	仕様	
原稿送り装置の種類	自動原稿送り装置	
原稿サイズ	1 枚だけ読み取る場合	自動連続読み取りの場合
	<b>■最大</b> コピー時 幅 297 mm × 長さ 420 mm ファクス送信/スキャン時 600 dpi 読み取り時： 幅 297 mm × 長さ 500 mm 600 dpi 以外の読み取り時： 幅 297 mm × 長さ 900 mm <b>■最小</b> 幅 120 mm × 長さ 100 mm	<b>■最大</b> 幅 297 mm × 長さ 420 mm <b>■最小</b> 148 mm × 210 mm
原稿種類	35～128 g/m <sup>2</sup>	52～105 g/m <sup>2</sup>
原稿積載枚数	A4 以下：50 枚 B4：40 枚 A3：30 枚	
原稿読み取り速度	26 枚/分 (A4  、600 dpi、モノクロ)	

## □ プリンター部仕様

項目	仕様
形式	内蔵型
メモリー容量	「基本仕様/コピー仕様」に準ずる
プリントサイズ	「基本仕様/コピー仕様」に準ずる
連続プリント速度	「基本仕様/コピー仕様」に準ずる
書き込み解像度	600 dpi × 600 dpi

項目		仕様
ページ記述	標準	GDI
言語	オプション	PCL 5e <sup>*2</sup> 、PCL XL <sup>*2</sup>
対応プロトコル		TCP/IP (LPR (IPv4)、Port9100)、IPP <sup>*3</sup> 、SNMP
インターフェイス		Ethernet 10BASE-T、100BASE-TX、1000BASE-T、USB2.0
エミュレーション		HP LaserJet 4250n <sup>*2</sup>
対応 OS <sup>*1</sup>		Windows® 10 Home(x86/x64) Windows® 10 Pro(x86/x64) Windows® 10 Education(x86/x64) Windows® 10 Enterprise(x86/x64) Windows® 8.1 (x86/x64) Windows® 8.1 Pro (x86/x64) Windows® 8.1 Enterprise (x86/x64) Windows® 7 Enterprise (x86/x64) Windows® 7 Professional (x86/x64) Windows® 7 Ultimate (x86/x64) Windows® 7 Home Premium (x86/x64) Windows Server® 2016 Datacenter Windows Server® 2016 Standard Windows Server® 2016 Essentials Windows Server® 2012 R2 Datacenter Windows Server® 2012 R2 Standard Windows Server® 2012 R2 Essentials Windows Server® 2012 R2 Foundation Windows Server® 2012 Datacenter Windows Server® 2012 Standard Windows Server® 2012 Essentials Windows Server® 2012 Foundation Windows Server® 2008 R2 Datacenter (x64) Windows Server® 2008 R2 Enterprise (x64) Windows Server® 2008 R2 Standard (x64) Windows Server® 2008 Datacenter (x86/x64) Windows Server® 2008 Enterprise (x86/x64) Windows Server® 2008 Standard (x86/x64)
内蔵フォント	PCL5e <sup>*2</sup>	和文 2 フォント (MS 明朝、MS ゴシック) 欧文 80 フォント
	PCLXL <sup>*2</sup>	欧文 80 フォント

\* 1 2018年5月現在。

\* 2 オプションのプリンタコントローラーキットが必要です。

\* 3 オプションの Information server が必要です。

## □ スキャナー部仕様

項目	仕様
形式	カラーレスキャナー
原稿サイズ	「自動原稿送り装置仕様」に準ずる
読み取り解像度	600 dpi × 600 dpi、300 dpi × 300 dpi、200 dpi × 200 dpi
原稿読み取り速度	42 枚/分 (A4  )、300 dpi、片面原稿、モノクロ)
対応プロトコル	TWAIN、HTTP <sup>*2</sup> 、CIFS (SMB) <sup>*2</sup> 、FTP <sup>*2</sup> 、SMTP <sup>*2</sup> 、SMTPS <sup>*2</sup>
インターフェイス	Ethernet 10BASE-T、100BASE-TX、1000BASE-T、USB2.0
対応 OS (TWAIN) <sup>*1</sup>	Windows® 10 Home(x86/x64) Windows® 10 Pro(x86/x64) Windows® 10 Education(x86/x64) Windows® 10 Enterprise(x86/x64) Windows® 8.1 (x86/x64) Windows® 8.1 Pro (x86/x64) Windows® 8.1 Enterprise (x86/x64) Windows® 7 Enterprise (x86/x64) Windows® 7 Professional (x86/x64) Windows® 7 Ultimate (x86/x64) Windows® 7 Home Premium (x86/x64) Windows Server® 2016 Datacenter <sup>*3</sup> Windows Server® 2016 Standard <sup>*3</sup> Windows Server® 2016 Essentials <sup>*3</sup> Windows Server® 2012 R2 Datacenter <sup>*3</sup> Windows Server® 2012 R2 Standard <sup>*3</sup> Windows Server® 2012 R2 Essentials <sup>*3</sup> Windows Server® 2012 R2 Foundation <sup>*3</sup> Windows Server® 2012 Datacenter <sup>*3</sup> Windows Server® 2012 Standard <sup>*3</sup> Windows Server® 2012 Essentials <sup>*3</sup> Windows Server® 2012 Foundation <sup>*3</sup> Windows Server® 2008 R2 Datacenter (x64) <sup>*3</sup> Windows Server® 2008 R2 Enterprise (x64) <sup>*3</sup> Windows Server® 2008 R2 Standard (x64) <sup>*3</sup> Windows Server® 2008 Datacenter (x86/x64) <sup>*3</sup> Windows Server® 2008 Enterprise (x86/x64) <sup>*3</sup> Windows Server® 2008 Standard (x86/x64) <sup>*3</sup>
出力フォーマット	TIFF、JPEG、PDF
ドライバー	TWAIN ドライバー

\* 1 2018年5月現在。

\* 2 オプションの Information server が必要です。

\* 3 ネットワークのみ使用できます。

## □ ファクス部仕様

項目	仕様
適用回線	加入電話回線
走査線密度	超高画質 主走査 600 dpi× 副走査 600 dpi または 主走査 16 画素 /mm × 副走査 15.4 本 /mm <sup>*1</sup> 高画質 主走査 8 画素 /mm× 副走査 7.7 本 /mm 標準 主走査 8 画素 /mm× 副走査 3.85 本 /mm 写真 主走査 8 画素 /mm× 副走査 7.7 本 /mm
通信速度	33 600、31 200、28 800、26 400、24 000、21 600、 19 200、16 800、14 400、12 000、9 600、7 200、4 800、 2 400 bit/s (自動切替)
符号化方式	MH、MR、MMR、JBIG
通信モード	スーパー G3、G3
送信原稿サイズ	A3、B4、A4
記録紙サイズ	B4 <sup>*2</sup> 、A4、B5、A5
電送時間	2 秒台 <sup>*3</sup>

\*1 該当モードを持たない装置とは交信できません。

\*2 オプションの増設給紙カセットが必要です。

\*3 A4 版 700 字程度の当社標準原稿を、標準画質 (8 画素 × 3.85 本 /mm)、スーパー G3 モード (ITU-TV.34 準拠 33 600 bit/s) で送信した場合の時間です。これは画像情報のみの電送速度で通信の制御時間は含まれていません。なお、実際の通信時間は原稿の内容、相手機種、回線の状態により異なります。G3 機との通信 (同じ原稿を 14 400 bit/s で送ったとき) では 6 秒台になります。一般の電話回線での通信速度は、回線の条件、状況によって 33 600 bit/s の速度以下になる場合もあります。

## □ PC-FAX 仕様 (Information server 装着時)

項目	仕様
原稿サイズ	A3、B4、A4
符号化方式	MH、MR、MMR、JBIG
通信規格	T.30 (FAX)、T.37 (I-FAX)
通信速度	最大 33 600 bit/s (FAX)、最大 100 M bit/s (I-FAX)
最大解像度	600 dpi × 600 dpi
宛先表	2 000 件
同報最大件数	4 060 件
対応 OS <sup>*1</sup> ファクスドライバー	Windows® 10 Home(x86/x64) Windows® 10 Pro(x86/x64) Windows® 10 Education(x86/x64) Windows® 10 Enterprise(x86/x64) Windows® 8.1 (x86/x64) Windows® 8.1 Pro (x86/x64) Windows® 8.1 Enterprise (x86/x64) Windows® 7 Enterprise (x86/x64) Windows® 7 Professional (x86/x64) Windows® 7 Ultimate (x86/x64) Windows® 7 Home Premium (x86/x64)

項目	仕様
	Windows Server® 2016 Datacenter
	Windows Server® 2016 Standard
	Windows Server® 2016 Essentials
	Windows Server® 2012 R2 Datacenter
	Windows Server® 2012 R2 Standard
	Windows Server® 2012 R2 Essentials
	Windows Server® 2012 R2 Foundation
	Windows Server® 2012 Datacenter
	Windows Server® 2012 Standard
	Windows Server® 2012 Essentials
	Windows Server® 2012 Foundation
	Windows Server® 2008 R2 Datacenter (x64)
	Windows Server® 2008 R2 Enterprise (x64)
	Windows Server® 2008 R2 Standard (x64)
	Windows Server® 2008 Datacenter (x86/x64)
	Windows Server® 2008 Enterprise (x86/x64)
	Windows Server® 2008 Standard (x86/x64)

\*1 2018年5月現在。

## □ インターネット FAX 仕様 (Information server 装着時)

項目	仕様
通信プロトコル	送信：SMTP/ESMTP 受信：SMTP/POP3
通信規格	ITU-T T.37 (Simple Mode、Full Mode)
符号化方式	MH、MR、MMR、JBIG
送信原稿サイズ	A3、B4、A4
走査線密度	超高画質 主走査 600 dpi× 副走査 600 dpi または 主走査 16 画素 /mm × 副走査 15.4 本 /mm *1 高画質 主走査 8 画素 /mm× 副走査 7.7 本 /mm 標準 主走査 8 画素 /mm× 副走査 3.85 本 /mm
データフォーマット	TIFF-S、TIFF-F、PDF

\*1 該当モードを持たない装置とは交信できません。



## □ Information server 仕様

項 目	仕 様
対応ブラウザ	Microsoft Internet® Explorer 8 Microsoft Internet® Explorer 9 Microsoft Internet® Explorer 10 Microsoft Internet® Explorer 11 Microsoft Edge™ Firefox® 36 Safari 7.0
動作環境	対応ブラウザおよび各ドライバー・ユーティリティーが動作する Windows 環境
メモリー <sup>*1</sup>	4 GB
蓄積枚数	約 10,000 枚 A4 標準原稿の場合
宛先表登録件数	2,000 件 グループ :200 件
登録可能ユーザー数	200 ユーザー
LDAP 対応サーバー	Active Directory : Windows Server® 2016、Windows Server® 2012、Windows Server® 2008 R2、Windows Server® 2008 OpenLDAP on Linux®
対応認証サーバー・プロトコル	Windows Server® 2016 (Active Directory) Windows Server® 2012 (Active Directory) Windows Server® 2008 R2 (Active Directory) Windows Server® 2008 (Active Directory) Kerberos v5

\* 1 画像メモリー領域は約 1 GB です。

## □ マルチアクセス

マルチアクセスとは、1つの作業をしているときに他の作業を同時におこなえる機能のことです。本商品では、最大3つまでの作業を同時に行うことができます。同時にできる作業の組み合わせは下表を参照してください。

○…できる △…優先応用機能のみ操作可能 ×…できない

1つ目の作業 2つ目の作業	リアルタイム送信	メモリー送信	受信	送信原稿読み取り	コピー原稿読み取り	受信・印字	リストの印字	PCプリント	スキャン
リアルタイム送信		x	x	x	x	○	○	○	x
メモリー送信	x		x	○	○	○	○	○	○
受信	x	x		○	○	○	○	○	○
送信原稿読み取り	x	○	○		x	○	○	○	x
コピー原稿読み取り	x	○	○	x		○	○	○	x
受信・印字	○	○	○	○	○		x	x	○
リストの印字	○	○	○	○	○	x		x	○
PCプリント	○	○	○	○	○	x	x		○
スキャン	x	○	○	x	x	○	○	○	
機器の操作	△	○	○	△	x	○	○	○	x

1つ目の作業 2つ目の作業 3つ目の作業	メモリー送信						受信					
	送信原稿読み取り	コピー原稿読み取り	受信・印字	リストの印字	PCプリント	TWAINスキャン	送信原稿読み取り	コピー原稿読み取り	受信・印字	リストの印字	PCプリント	スキャン
リアルタイム送信	x	x	x	x	x	x	x	x	x	x	x	x
メモリー送信							x	x	x	x	x	x
受信	x	x	x	x	x	x						
送信原稿読み取り		x	○	○	○	x		x	○	○	○	x
コピー原稿読み取り	x		○	○	○	x	x		○	○	○	x
受信・印字	○	○		x	x	○	○	○		x	x	○
リストの印字	○	○	x		x	○	○	○	x		x	○
PCプリント	○	○	x	x		○	○	○	x	x		○
スキャン	x	x	○	○	○		x	x	○	○	○	
機器の操作	△	x	○	○	○	x	△	x	○	○	○	x

1つ目の作業 2つ目の作業 3つ目の作業	送信原稿読み取り			コピー原稿読み取り			スキャン		
	受信・印字	リストの印字	PCプリント	受信・印字	リストの印字	PCプリント	受信・印字	リストの印字	PCプリント
リアルタイム送信	x	x	x	x	x	x	x	x	x
メモリー送信	○	○	○	○	○	○	○	○	○
受信	○	○	○	○	○	○	○	○	○
送信原稿読み取り				x	x	x	x	x	x
コピー原稿読み取り	x	x	x				x	x	x
受信・印字		x	x		x	x		x	x
リストの印字	x		x	x		x	x		x
PCプリント	x	x		x	x		x	x	x
スキャン	x	x	x	x	x	x			
機器の操作	△	△	△	x	x	x	x	x	x

# 外形寸法

標準仕様

(単位:mm)

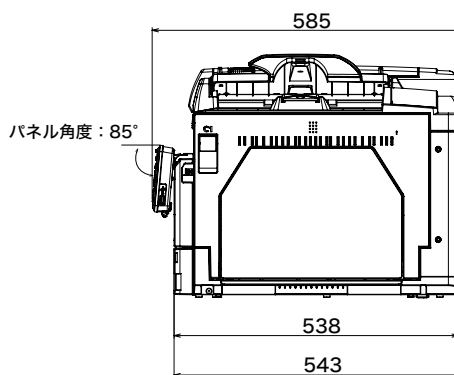
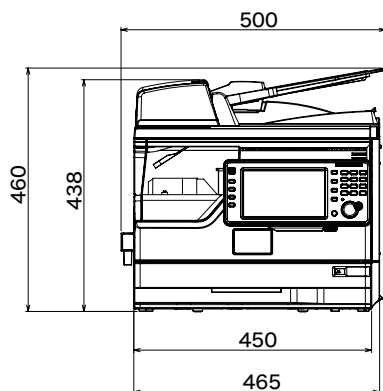
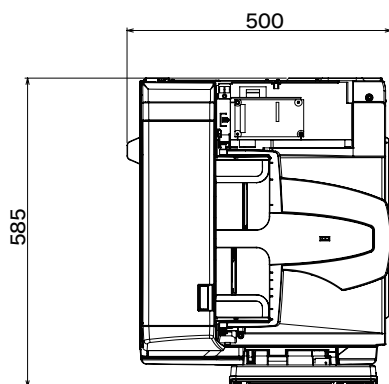

最大

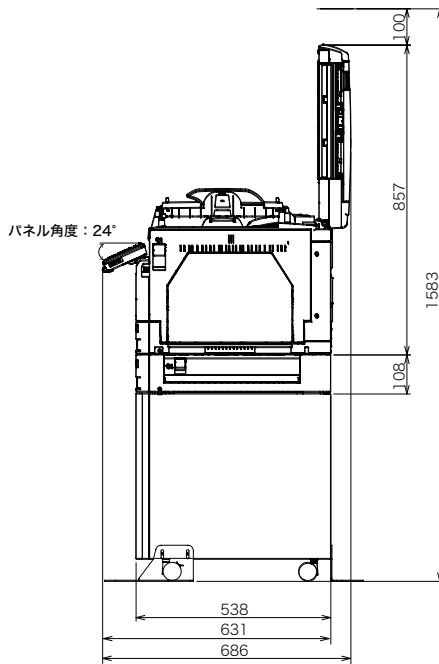

(単位:mm)

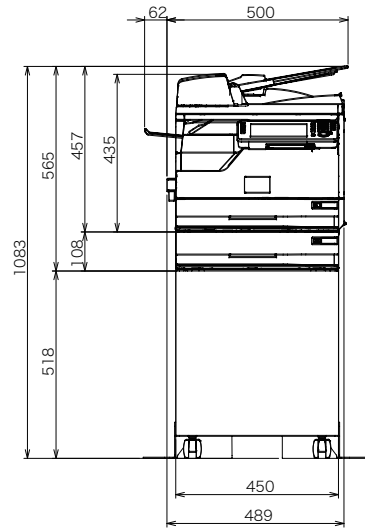

本体 + 増設給紙カセット + 専用台

3

主な仕様

(空白ページ)

# 第4章

## 商標および著作権について

---

商標および著作権などについて .....	4-2
登録商標および商標について .....	4-2
オープンソースソフトウェアに対応するソースコードの頒布について .....	4-2
オープンソースライセンスについて .....	4-2

# 商標および著作権などについて

## 登録商標および商標について

---

- RSA® は RSA Security Inc. の登録商標です。BSAFE® は RSA Security Inc. の米国およびその他の国における登録商標です。本商品は、RSA Security Inc. の RSA® BSAFE™ ソフトウェアを搭載しています。
-  Monotype Imaging
  - ◆ Monotype is a trademark of Monotype Imaging, Inc. registered in the United States Patent and Trademark Office and may be registered in certain jurisdictions. The Monotype Imaging logo is a trademark of Monotype Imaging, Inc. and may be registered in certain jurisdictions.
  - ◆ UFST is a trademark of Monotype Imaging, Inc. and may be registered in certain jurisdictions.
- 記載されている会社名およびサービス・製品の名称は各社の商標または登録商標です。

## オープンソースソフトウェアに対応するソースコードの頒布について

---

本商品には、オープンソースソフトウェアが含まれます。オープンソースソフトウェアのうち GPL (GNU GENERAL PUBLIC LICENSE)、LGPL (GNU LESSER GENERAL PUBLIC LICENSE)、または Sleepy Cat Software License の条件にて利用許諾されるものが含まれる場合には、各ライセンスの利用許諾条件に従い、弊社は、下記の CONTACT 情報宛に CONTACT してきた個人・団体に対し、お買い上げ後、少なくとも 3 年間、実費にて GPL/LGPL/ Sleepy Cat Software License ソフトウェアに対応するソースコードを、CD-ROM などの媒体により頒布します。

CONTACT 情報  
ce-support@syd.muratec.co.jp

## オープンソースライセンスについて

---

### □ libstdc++

GCC is Copyright (C) 1986, 1987, 1988, 1989, 1990, 1991, 1992, 1993, 1994, 1995, 1996, 1997, 1998, 1999, 2000, 2001, 2002, 2003, 2004, 2005, 2006, 2007, 2008 Free Software Foundation, Inc.

GCC is free software; you can redistribute it and/or modify it under the terms of the GNU General Public License as published by the Free Software Foundation; either version 3, or (at your option) any later version.

GCC is distributed in the hope that it will be useful, but WITHOUT ANY WARRANTY; without even the implied warranty of MERCHANTABILITY or FITNESS FOR A PARTICULAR PURPOSE. See the GNU General Public License for more details.

Files that have exception clauses are licensed under the terms of the GNU General Public License; either version 2, or (at your option) any later version.

On Debian GNU/Linux systems, the complete text of the GNU General Public License is in `/usr/share/common-licenses/GPL`, version 2 of this license in `/usr/`

share/common-licenses/GPL-2'.

The libstdc++-v3 library is licensed under the terms of the GNU General Public License, with this special exception:

As a special exception, you may use this file as part of a free software library without restriction. Specifically, if other files instantiate templates or use macros or inline functions from this file, or you compile this file and link it with other files to produce an executable, this file does not by itself cause the resulting executable to be covered by the GNU General Public License. This exception does not however invalidate any other reasons why the executable file might be covered by the GNU General Public License.

GNU GENERAL PUBLIC LICENSE  
Version 2, June 1991

Copyright (C) 1989, 1991 Free Software Foundation, Inc., 51 Franklin Street, Fifth Floor, Boston, MA 02110-1301 USA Everyone is permitted to copy and distribute verbatim copies of this license document, but changing it is not allowed.

Preamble

The licenses for most software are designed to take away your freedom to share and change it. By contrast, the GNU General Public License is intended to guarantee your freedom to share and change free software--to make sure the software is free for all its users. This General Public License applies to most of the Free Software Foundation's software and to any other program whose authors commit to using it. (Some other Free Software Foundation software is covered by the GNU Lesser General Public License instead.) You can apply it to your programs, too.

When we speak of free software, we are referring to freedom, not price. Our General Public Licenses are designed to make sure that you have the freedom to distribute copies of free software (and charge for this service if you wish), that you receive source code or can get it if you want it, that you can change the software or use pieces of it in new free programs; and that you know you can do these things.

To protect your rights, we need to make restrictions that forbid anyone to deny you these rights or to ask you to surrender the rights. These restrictions translate to certain responsibilities for you if you distribute copies of the software, or if you modify it.

For example, if you distribute copies of such a program, whether gratis or for a fee, you must give the recipients all the rights that you have. You must make sure that they, too, receive or can get the source code. And you must show them these terms so they know their rights.

We protect your rights with two steps: (1) copyright the software, and (2) offer you this license which gives you legal permission to copy, distribute and/or modify the software.

Also, for each author's protection and ours, we want to make certain that everyone understands that there is no warranty for this free software. If the software is modified by someone else and passed on, we want its recipients to know that what they have is not the original, so that any problems introduced by others will not reflect on the original authors' reputations.



Finally, any free program is threatened constantly by software patents. We wish to avoid the danger that redistributors of a free program will individually obtain patent licenses, in effect making the program proprietary. To prevent this, we have made it clear that any patent must be licensed for everyone's free use or not licensed at all.

The precise terms and conditions for copying, distribution and modification follow.

## GNU GENERAL PUBLIC LICENSE TERMS AND CONDITIONS FOR COPYING, DISTRIBUTION AND MODIFICATION

0. This License applies to any program or other work which contains a notice placed by the copyright holder saying it may be distributed under the terms of this General Public License. The "Program", below, refers to any such program or work, and a "work based on the Program" means either the Program or any derivative work under copyright law: that is to say, a work containing the Program or a portion of it, either verbatim or with modifications and/or translated into another language. (Hereinafter, translation is included without limitation in the term "modification".) Each licensee is addressed as "you".

Activities other than copying, distribution and modification are not covered by this License; they are outside its scope. The act of running the Program is not restricted, and the output from the Program is covered only if its contents constitute a work based on the Program (independent of having been made by running the Program). Whether that is true depends on what the Program does.

1. You may copy and distribute verbatim copies of the Program's source code as you receive it, in any medium, provided that you conspicuously and appropriately publish on each copy an appropriate copyright notice and disclaimer of warranty; keep intact all the notices that refer to this License and to the absence of any warranty; and give any other recipients of the Program a copy of this License along with the Program.

You may charge a fee for the physical act of transferring a copy, and you may at your option offer warranty protection in exchange for a fee.

2. You may modify your copy or copies of the Program or any portion of it, thus forming a work based on the Program, and copy and distribute such modifications or work under the terms of Section 1 above, provided that you also meet all of these conditions:

a) You must cause the modified files to carry prominent notices stating that you changed the files and the date of any change.

b) You must cause any work that you distribute or publish, that in whole or in part contains or is derived from the Program or any part thereof, to be licensed as a whole at no charge to all third parties under the terms of this License.

c) If the modified program normally reads commands interactively when run, you must cause it, when started running for such interactive use in the most ordinary way, to print or display an announcement including an appropriate copyright notice and a notice that there is no warranty (or else, saying that you provide a warranty) and that users may redistribute the program under these conditions, and telling the user how to view a copy of this License. (Exception: if the Program itself is interactive but does not normally print such an announcement, your work based on the Program is not required to print an announcement.)

These requirements apply to the modified work as a whole. If identifiable sections of that work are not derived from the Program, and can be reasonably considered

independent and separate works in themselves, then this License, and its terms, do not apply to those sections when you distribute them as separate works. But when you distribute the same sections as part of a whole which is a work based on the Program, the distribution of the whole must be on the terms of this License, whose permissions for other licensees extend to the entire whole, and thus to each and every part regardless of who wrote it.

Thus, it is not the intent of this section to claim rights or contest your rights to work written entirely by you; rather, the intent is to exercise the right to control the distribution of derivative or collective works based on the Program.

In addition, mere aggregation of another work not based on the Program with the Program (or with a work based on the Program) on a volume of a storage or distribution medium does not bring the other work under the scope of this License.

3. You may copy and distribute the Program (or a work based on it, under Section 2) in object code or executable form under the terms of Sections 1 and 2 above provided that you also do one of the following:

a) Accompany it with the complete corresponding machine-readable source code, which must be distributed under the terms of Sections 1 and 2 above on a medium customarily used for software interchange; or,

b) Accompany it with a written offer, valid for at least three years, to give any third party, for a charge no more than your cost of physically performing source distribution, a complete machine-readable copy of the corresponding source code, to be distributed under the terms of Sections 1 and 2 above on a medium customarily used for software interchange; or,

c) Accompany it with the information you received as to the offer to distribute corresponding source code. (This alternative is allowed only for noncommercial distribution and only if you received the program in object code or executable form with such an offer, in accord with Subsection b above.)

The source code for a work means the preferred form of the work for making modifications to it. For an executable work, complete source code means all the source code for all modules it contains, plus any associated interface definition files, plus the scripts used to control compilation and installation of the executable. However, as a special exception, the source code distributed need not include anything that is normally distributed (in either source or binary form) with the major components (compiler, kernel, and so on) of the operating system on which the executable runs, unless that component itself accompanies the executable.

If distribution of executable or object code is made by offering access to copy from a designated place, then offering equivalent access to copy the source code from the same place counts as distribution of the source code, even though third parties are not compelled to copy the source along with the object code.

4. You may not copy, modify, sublicense, or distribute the Program except as expressly provided under this License. Any attempt otherwise to copy, modify, sublicense or distribute the Program is void, and will automatically terminate your rights under this License. However, parties who have received copies, or rights, from you under this License will not have their licenses terminated so long as such parties remain in full compliance.

5. You are not required to accept this License, since you have not signed it. However, nothing else grants you permission to modify or distribute the Program

or its derivative works. These actions are prohibited by law if you do not accept this License. Therefore, by modifying or distributing the Program (or any work based on the Program), you indicate your acceptance of this License to do so, and all its terms and conditions for copying, distributing or modifying the Program or works based on it.

6. Each time you redistribute the Program (or any work based on the Program), the recipient automatically receives a license from the original licensor to copy, distribute or modify the Program subject to these terms and conditions. You may not impose any further restrictions on the recipients' exercise of the rights granted herein. You are not responsible for enforcing compliance by third parties to this License.

7. If, as a consequence of a court judgment or allegation of patent infringement or for any other reason (not limited to patent issues), conditions are imposed on you (whether by court order, agreement or otherwise) that contradict the conditions of this License, they do not excuse you from the conditions of this License. If you cannot distribute so as to satisfy simultaneously your obligations under this License and any other pertinent obligations, then as a consequence you may not distribute the Program at all. For example, if a patent license would not permit royalty-free redistribution of the Program by all those who receive copies directly or indirectly through you, then the only way you could satisfy both it and this License would be to refrain entirely from distribution of the Program.

If any portion of this section is held invalid or unenforceable under any particular circumstance, the balance of the section is intended to apply and the section as a whole is intended to apply in other circumstances.

It is not the purpose of this section to induce you to infringe any patents or other property right claims or to contest validity of any such claims; this section has the sole purpose of protecting the integrity of the free software distribution system, which is implemented by public license practices. Many people have made generous contributions to the wide range of software distributed through that system in reliance on consistent application of that system; it is up to the author/donor to decide if he or she is willing to distribute software through any other system and a licensee cannot impose that choice.

This section is intended to make thoroughly clear what is believed to be a consequence of the rest of this License.

8. If the distribution and/or use of the Program is restricted in certain countries either by patents or by copyrighted interfaces, the original copyright holder who places the Program under this License may add an explicit geographical distribution limitation excluding those countries, so that distribution is permitted only in or among countries not thus excluded. In such case, this License incorporates the limitation as if written in the body of this License.

9. The Free Software Foundation may publish revised and/or new versions of the General Public License from time to time. Such new versions will be similar in spirit to the present version, but may differ in detail to address new problems or concerns.

Each version is given a distinguishing version number. If the Program specifies a version number of this License which applies to it and "any later version", you have the option of following the terms and conditions either of that version or of any later version published by the Free Software Foundation. If the Program does not specify a version number of this License, you may choose any version ever published by the Free Software Foundation.

10. If you wish to incorporate parts of the Program into other free programs whose distribution conditions are different, write to the author to ask for permission. For software which is copyrighted by the Free Software Foundation, write to the Free Software Foundation; we sometimes make exceptions for this. Our decision will be guided by the two goals of preserving the free status of all derivatives of our free software and of promoting the sharing and reuse of software generally.

#### NO WARRANTY

11. BECAUSE THE PROGRAM IS LICENSED FREE OF CHARGE, THERE IS NO WARRANTY FOR THE PROGRAM, TO THE EXTENT PERMITTED BY APPLICABLE LAW. EXCEPT WHEN OTHERWISE STATED IN WRITING THE COPYRIGHT HOLDERS AND/OR OTHER PARTIES PROVIDE THE PROGRAM "AS IS" WITHOUT WARRANTY OF ANY KIND, EITHER EXPRESSED OR IMPLIED, INCLUDING, BUT NOT LIMITED TO, THE IMPLIED WARRANTIES OF MERCHANTABILITY AND FITNESS FOR A PARTICULAR PURPOSE. THE ENTIRE RISK AS TO THE QUALITY AND PERFORMANCE OF THE PROGRAM IS WITH YOU. SHOULD THE PROGRAM PROVE DEFECTIVE, YOU ASSUME THE COST OF ALL NECESSARY SERVICING, REPAIR OR CORRECTION.

12. IN NO EVENT UNLESS REQUIRED BY APPLICABLE LAW OR AGREED TO IN WRITING WILL ANY COPYRIGHT HOLDER, OR ANY OTHER PARTY WHO MAY MODIFY AND/OR REDISTRIBUTE THE PROGRAM AS PERMITTED ABOVE, BE LIABLE TO YOU FOR DAMAGES, INCLUDING ANY GENERAL, SPECIAL, INCIDENTAL OR CONSEQUENTIAL DAMAGES ARISING OUT OF THE USE OR INABILITY TO USE THE PROGRAM (INCLUDING BUT NOT LIMITED TO LOSS OF DATA OR DATA BEING RENDERED INACCURATE OR LOSSES SUSTAINED BY YOU OR THIRD PARTIES OR A FAILURE OF THE PROGRAM TO OPERATE WITH ANY OTHER PROGRAMS), EVEN IF SUCH HOLDER OR OTHER PARTY HAS BEEN ADVISED OF THE POSSIBILITY OF SUCH DAMAGES.

#### END OF TERMS AND CONDITIONS

##### How to Apply These Terms to Your New Programs

If you develop a new program, and you want it to be of the greatest possible use to the public, the best way to achieve this is to make it free software which everyone can redistribute and change under these terms.

To do so, attach the following notices to the program. It is safest to attach them to the start of each source file to most effectively convey the exclusion of warranty; and each file should have at least the "copyright" line and a pointer to where the full notice is found.

```
<one line to give the program's name and a brief idea of what it does.>  
Copyright (C) <year> <name of author>
```

This program is free software; you can redistribute it and/or modify it under the terms of the GNU General Public License as published by the Free Software Foundation; either version 2 of the License, or (at your option) any later version.

This program is distributed in the hope that it will be useful, but WITHOUT ANY WARRANTY; without even the implied warranty of MERCHANTABILITY or FITNESS FOR A PARTICULAR PURPOSE. See the GNU General Public License for more details.

You should have received a copy of the GNU General Public License along with this program; if not, write to the Free Software Foundation, Inc., 51 Franklin Street, Fifth Floor, Boston, MA 02110-1301 USA.

Also add information on how to contact you by electronic and paper mail.

If the program is interactive, make it output a short notice like this when it starts in an interactive mode:

```
Gnomovision version 69, Copyright (C) year name of author
Gnomovision comes with ABSOLUTELY NO WARRANTY; for details type `show w'.
This is free software, and you are welcome to redistribute it under certain
conditions; type `show c' for details.
```

The hypothetical commands ``show w'` and ``show c'` should show the appropriate parts of the General Public License. Of course, the commands you use may be called something other than ``show w'` and ``show c'`; they could even be mouse-clicks or menu items--whatever suits your program.

You should also get your employer (if you work as a programmer) or your school, if any, to sign a "copyright disclaimer" for the program, if necessary. Here is a sample; alter the names:

```
Yoyodyne, Inc., hereby disclaims all copyright interest in the program
`Gnomovision' (which makes passes at compilers) written by James Hacker.
```

```
<signature of Ty Coon>, 1 April 1989
Ty Coon, President of Vice
```

This General Public License does not permit incorporating your program into proprietary programs. If your program is a subroutine library, you may consider it more useful to permit linking proprietary applications with the library. If this is what you want to do, use the GNU Lesser General Public License instead of this License.

## □ SQLite 3.7.2

SQLite Is Public Domain

All of the code and documentation in SQLite has been dedicated to the public domain by the authors. All code authors, and representatives of the companies they work for, have signed affidavits dedicating their contributions to the public domain and originals of those signed affidavits are stored in a firesafe at the main offices of Hwaci. Anyone is free to copy, modify, publish, use, compile, sell, or distribute the original SQLite code, either in source code form or as a compiled binary, for any purpose, commercial or non-commercial, and by any means.

The previous paragraph applies to the deliverable code and documentation in SQLite - those parts of the SQLite library that you actually bundle and ship with a larger application. Some scripts used as part of the build process (for example the "configure" scripts generated by autoconf) might fall under other open-source licenses. Nothing from these build scripts ever reaches the final deliverable SQLite library, however, and so the licenses associated with those scripts should not be a factor in assessing your rights to copy and use the SQLite library.

All of the deliverable code in SQLite has been written from scratch. No code has been taken from other projects or from the open internet. Every line of code can be traced back to its original author, and all of those authors have public domain dedications on file. So the SQLite code base is clean and is uncontaminated with

licensed code from other projects.

## □ Apache Tomcat 7.0.47

Copyright 1999-2013 The Apache Software Foundation

Apache License  
Version 2.0, January 2004  
<http://www.apache.org/licenses/>

TERMS AND CONDITIONS FOR USE, REPRODUCTION, AND DISTRIBUTION

### 1. Definitions.

"License" shall mean the terms and conditions for use, reproduction, and distribution as defined by Sections 1 through 9 of this document.

"Licensor" shall mean the copyright owner or entity authorized by the copyright owner that is granting the License.

"Legal Entity" shall mean the union of the acting entity and all other entities that control, are controlled by, or are under common control with that entity. For the purposes of this definition, "control" means (i) the power, direct or indirect, to cause the direction or management of such entity, whether by contract or otherwise, or (ii) ownership of fifty percent (50%) or more of the outstanding shares, or (iii) beneficial ownership of such entity.

"You" (or "Your") shall mean an individual or Legal Entity exercising permissions granted by this License.

"Source" form shall mean the preferred form for making modifications, including but not limited to software source code, documentation source, and configuration files.

"Object" form shall mean any form resulting from mechanical transformation or translation of a Source form, including but not limited to compiled object code, generated documentation, and conversions to other media types.

"Work" shall mean the work of authorship, whether in Source or Object form, made available under the License, as indicated by a copyright notice that is included in or attached to the work (an example is provided in the Appendix below).

"Derivative Works" shall mean any work, whether in Source or Object form, that is based on (or derived from) the Work and for which the editorial revisions, annotations, elaborations, or other modifications represent, as a whole, an original work of authorship. For the purposes of this License, Derivative Works shall not include works that remain separable from, or merely link (or bind by name) to the interfaces of, the Work and Derivative Works thereof.

"Contribution" shall mean any work of authorship, including the original version of the Work and any modifications or additions to that Work or Derivative Works thereof, that is intentionally submitted to Licensor for inclusion in the Work by the copyright owner or by an individual or Legal Entity authorized to submit on behalf of the copyright owner. For the purposes of this definition, "submitted" means any form of electronic, verbal, or written communication sent to the Licensor or its representatives, including but not limited to communication on electronic mailing



lists, source code control systems, and issue tracking systems that are managed by, or on behalf of, the Licensor for the purpose of discussing and improving the Work, but excluding communication that is conspicuously marked or otherwise designated in writing by the copyright owner as "Not a Contribution."

"Contributor" shall mean Licensor and any individual or Legal Entity on behalf of whom a Contribution has been received by Licensor and subsequently incorporated within the Work.

2. Grant of Copyright License. Subject to the terms and conditions of this License, each Contributor hereby grants to You a perpetual, worldwide, non-exclusive, no-charge, royalty-free, irrevocable copyright license to reproduce, prepare Derivative Works of, publicly display, publicly perform, sublicense, and distribute the Work and such Derivative Works in Source or Object form.

3. Grant of Patent License. Subject to the terms and conditions of this License, each Contributor hereby grants to You a perpetual, worldwide, non-exclusive, no-charge, royalty-free, irrevocable (except as stated in this section) patent license to make, have made, use, offer to sell, sell, import, and otherwise transfer the Work, where such license applies only to those patent claims licensable by such Contributor that are necessarily infringed by their Contribution(s) alone or by combination of their Contribution(s) with the Work to which such Contribution(s) was submitted. If You institute patent litigation against any entity (including a cross-claim or counterclaim in a lawsuit) alleging that the Work or a Contribution incorporated within the Work constitutes direct or contributory patent infringement, then any patent licenses granted to You under this License for that Work shall terminate as of the date such litigation is filed.

4. Redistribution. You may reproduce and distribute copies of the Work or Derivative Works thereof in any medium, with or without modifications, and in Source or Object form, provided that You meet the following conditions:

(a) You must give any other recipients of the Work or Derivative Works a copy of this License; and

(b) You must cause any modified files to carry prominent notices stating that You changed the files; and

(c) You must retain, in the Source form of any Derivative Works that You distribute, all copyright, patent, trademark, and attribution notices from the Source form of the Work, excluding those notices that do not pertain to any part of the Derivative Works; and

(d) If the Work includes a "NOTICE" text file as part of its distribution, then any Derivative Works that You distribute must include a readable copy of the attribution notices contained within such NOTICE file, excluding those notices that do not pertain to any part of the Derivative Works, in at least one of the following places: within a NOTICE text file distributed as part of the Derivative Works; within the Source form or documentation, if provided along with the Derivative Works; or, within a display generated by the Derivative Works, if and wherever such third-party notices normally appear. The contents of the NOTICE file are for informational purposes only and do not modify the License. You may add Your own attribution notices within Derivative Works that You distribute, alongside or as an addendum to the NOTICE text from the Work, provided that such additional attribution notices cannot be construed as modifying the License.

You may add Your own copyright statement to Your modifications and may provide additional or different license terms and conditions for use, reproduction,

or distribution of Your modifications, or for any such Derivative Works as a whole, provided Your use, reproduction, and distribution of the Work otherwise complies with the conditions stated in this License.

5. Submission of Contributions. Unless You explicitly state otherwise, any Contribution intentionally submitted for inclusion in the Work by You to the Licensor shall be under the terms and conditions of this License, without any additional terms or conditions. Notwithstanding the above, nothing herein shall supersede or modify the terms of any separate license agreement you may have executed with Licensor regarding such Contributions.

6. Trademarks. This License does not grant permission to use the trade names, trademarks, service marks, or product names of the Licensor, except as required for reasonable and customary use in describing the origin of the Work and reproducing the content of the NOTICE file.

7. Disclaimer of Warranty. Unless required by applicable law or agreed to in writing, Licensor provides the Work (and each Contributor provides its Contributions) on an "AS IS" BASIS, WITHOUT WARRANTIES OR CONDITIONS OF ANY KIND, either express or implied, including, without limitation, any warranties or conditions of TITLE, NON-INFRINGEMENT, MERCHANTABILITY, or FITNESS FOR A PARTICULAR PURPOSE. You are solely responsible for determining the appropriateness of using or redistributing the Work and assume any risks associated with Your exercise of permissions under this License.

8. Limitation of Liability. In no event and under no legal theory, whether in tort (including negligence), contract, or otherwise, unless required by applicable law (such as deliberate and grossly negligent acts) or agreed to in writing, shall any Contributor be liable to You for damages, including any direct, indirect, special, incidental, or consequential damages of any character arising as a result of this License or out of the use or inability to use the Work (including but not limited to damages for loss of goodwill, work stoppage, computer failure or malfunction, or any and all other commercial damages or losses), even if such Contributor has been advised of the possibility of such damages.

9. Accepting Warranty or Additional Liability. While redistributing the Work or Derivative Works thereof, You may choose to offer, and charge a fee for, acceptance of support, warranty, indemnity, or other liability obligations and/or rights consistent with this License. However, in accepting such obligations, You may act only on Your own behalf and on Your sole responsibility, not on behalf of any other Contributor, and only if You agree to indemnify, defend, and hold each Contributor harmless for any liability incurred by, or claims asserted against, such Contributor by reason of your accepting any such warranty or additional liability.

END OF TERMS AND CONDITIONS

APPENDIX: How to apply the Apache License to your work.

To apply the Apache License to your work, attach the following boilerplate notice, with the fields enclosed by brackets "[]" replaced with your own identifying information. (Don't include the brackets!) The text should be enclosed in the appropriate comment syntax for the file format. We also recommend that a file or class name and description of purpose be included on the same "printed page" as the copyright notice for easier identification within third-party archives.

Copyright [yyyy] [name of copyright owner]

Licensed under the Apache License, Version 2.0 (the "License"); you may not use



this file except in compliance with the License. You may obtain a copy of the License at

<http://www.apache.org/licenses/LICENSE-2.0>

Unless required by applicable law or agreed to in writing, software distributed under the License is distributed on an "AS IS" BASIS, WITHOUT WARRANTIES OR CONDITIONS OF ANY KIND, either express or implied. See the License for the specific language governing permissions and limitations under the License.

#### APACHE TOMCAT SUBCOMPONENTS:

Apache Tomcat includes a number of subcomponents with separate copyright notices and license terms. Your use of these subcomponents is subject to the terms and conditions of the following licenses.

For the ecj-x.x.x.jar component:

Eclipse Public License - v 1.0

THE ACCOMPANYING PROGRAM IS PROVIDED UNDER THE TERMS OF THIS ECLIPSE PUBLIC LICENSE ("AGREEMENT"). ANY USE, REPRODUCTION OR DISTRIBUTION OF THE PROGRAM CONSTITUTES RECIPIENT'S ACCEPTANCE OF THIS AGREEMENT.

#### 1. DEFINITIONS

"Contribution" means:

a) in the case of the initial Contributor, the initial code and documentation distributed under this Agreement, and

b) in the case of each subsequent Contributor:

i) changes to the Program, and

ii) additions to the Program;

where such changes and/or additions to the Program originate from and are distributed by that particular Contributor. A Contribution 'originates' from a Contributor if it was added to the Program by such Contributor itself or anyone acting on such Contributor's behalf. Contributions do not include additions to the Program which: (i) are separate modules of software distributed in conjunction with the Program under their own license agreement, and (ii) are not derivative works of the Program.

"Contributor" means any person or entity that distributes the Program.

"Licensed Patents" mean patent claims licensable by a Contributor which are necessarily infringed by the use or sale of its Contribution alone or when combined with the Program.

"Program" means the Contributions distributed in accordance with this Agreement.

"Recipient" means anyone who receives the Program under this Agreement, including all Contributors.

## 2. GRANT OF RIGHTS

a) Subject to the terms of this Agreement, each Contributor hereby grants Recipient a non-exclusive, worldwide, royalty-free copyright license to reproduce, prepare derivative works of, publicly display, publicly perform, distribute and sublicense the Contribution of such Contributor, if any, and such derivative works, in source code and object code form.

b) Subject to the terms of this Agreement, each Contributor hereby grants Recipient a non-exclusive, worldwide, royalty-free patent license under Licensed Patents to make, use, sell, offer to sell, import and otherwise transfer the Contribution of such Contributor, if any, in source code and object code form. This patent license shall apply to the combination of the Contribution and the Program if, at the time the Contribution is added by the Contributor, such addition of the Contribution causes such combination to be covered by the Licensed Patents. The patent license shall not apply to any other combinations which include the Contribution. No hardware per se is licensed hereunder.

c) Recipient understands that although each Contributor grants the licenses to its Contributions set forth herein, no assurances are provided by any Contributor that the Program does not infringe the patent or other intellectual property rights of any other entity. Each Contributor disclaims any liability to Recipient for claims brought by any other entity based on infringement of intellectual property rights or otherwise. As a condition to exercising the rights and licenses granted hereunder, each Recipient hereby assumes sole responsibility to secure any other intellectual property rights needed, if any. For example, if a third party patent license is required to allow Recipient to distribute the Program, it is Recipient's responsibility to acquire that license before distributing the Program.

d) Each Contributor represents that to its knowledge it has sufficient copyright rights in its Contribution, if any, to grant the copyright license set forth in this Agreement.

## 3. REQUIREMENTS

A Contributor may choose to distribute the Program in object code form under its own license agreement, provided that:

a) it complies with the terms and conditions of this Agreement; and

b) its license agreement:

i) effectively disclaims on behalf of all Contributors all warranties and conditions, express and implied, including warranties or conditions of title and non-infringement, and implied warranties or conditions of merchantability and fitness for a particular purpose;

ii) effectively excludes on behalf of all Contributors all liability for damages, including direct, indirect, special, incidental and consequential damages, such as lost profits;

iii) states that any provisions which differ from this Agreement are offered by that Contributor alone and not by any other party; and

iv) states that source code for the Program is available from such Contributor, and informs licensees how to obtain it in a reasonable manner on or through a medium customarily used for software exchange.

When the Program is made available in source code form:

- a) it must be made available under this Agreement; and
- b) a copy of this Agreement must be included with each copy of the Program.

Contributors may not remove or alter any copyright notices contained within the Program.

Each Contributor must identify itself as the originator of its Contribution, if any, in a manner that reasonably allows subsequent Recipients to identify the originator of the Contribution.

#### 4. COMMERCIAL DISTRIBUTION

Commercial distributors of software may accept certain responsibilities with respect to end users, business partners and the like. While this license is intended to facilitate the commercial use of the Program, the Contributor who includes the Program in a commercial product offering should do so in a manner which does not create potential liability for other Contributors. Therefore, if a Contributor includes the Program in a commercial product offering, such Contributor ("Commercial Contributor") hereby agrees to defend and indemnify every other Contributor ("Indemnified Contributor") against any losses, damages and costs (collectively "Losses") arising from claims, lawsuits and other legal actions brought by a third party against the Indemnified Contributor to the extent caused by the acts or omissions of such Commercial Contributor in connection with its distribution of the Program in a commercial product offering. The obligations in this section do not apply to any claims or Losses relating to any actual or alleged intellectual property infringement. In order to qualify, an Indemnified Contributor must: a) promptly notify the Commercial Contributor in writing of such claim, and b) allow the Commercial Contributor to control, and cooperate with the Commercial Contributor in, the defense and any related settlement negotiations. The Indemnified Contributor may participate in any such claim at its own expense.

For example, a Contributor might include the Program in a commercial product offering, Product X. That Contributor is then a Commercial Contributor. If that Commercial Contributor then makes performance claims, or offers warranties related to Product X, those performance claims and warranties are such Commercial Contributor's responsibility alone. Under this section, the Commercial Contributor would have to defend claims against the other Contributors related to those performance claims and warranties, and if a court requires any other Contributor to pay any damages as a result, the Commercial Contributor must pay those damages.

#### 5. NO WARRANTY

EXCEPT AS EXPRESSLY SET FORTH IN THIS AGREEMENT, THE PROGRAM IS PROVIDED ON AN "AS IS" BASIS, WITHOUT WARRANTIES OR CONDITIONS OF ANY KIND, EITHER EXPRESS OR IMPLIED INCLUDING, WITHOUT LIMITATION, ANY WARRANTIES OR CONDITIONS OF TITLE, NON-INFRINGEMENT, MERCHANTABILITY OR FITNESS FOR A PARTICULAR PURPOSE. Each Recipient is solely responsible for determining the appropriateness of using and distributing the Program and assumes all risks associated with its exercise of rights under this Agreement, including but not limited to the risks and costs of program errors, compliance with applicable laws, damage to or loss of data, programs or equipment, and unavailability or interruption of operations.

#### 6. DISCLAIMER OF LIABILITY

EXCEPT AS EXPRESSLY SET FORTH IN THIS AGREEMENT, NEITHER RECIPIENT NOR ANY CONTRIBUTORS SHALL HAVE ANY LIABILITY FOR ANY DIRECT, INDIRECT, INCIDENTAL, SPECIAL, EXEMPLARY, OR CONSEQUENTIAL DAMAGES (INCLUDING WITHOUT LIMITATION LOST PROFITS), HOWEVER CAUSED AND ON ANY THEORY OF LIABILITY, WHETHER IN CONTRACT, STRICT LIABILITY, OR TORT (INCLUDING NEGLIGENCE OR OTHERWISE) ARISING IN ANY WAY OUT OF THE USE OR DISTRIBUTION OF THE PROGRAM OR THE EXERCISE OF ANY RIGHTS GRANTED HEREUNDER, EVEN IF ADVISED OF THE POSSIBILITY OF SUCH DAMAGES.

## 7. GENERAL

If any provision of this Agreement is invalid or unenforceable under applicable law, it shall not affect the validity or enforceability of the remainder of the terms of this Agreement, and without further action by the parties hereto, such provision shall be reformed to the minimum extent necessary to make such provision valid and enforceable.

If Recipient institutes patent litigation against any entity (including a cross-claim or counterclaim in a lawsuit) alleging that the Program itself (excluding combinations of the Program with other software or hardware) infringes such Recipient's patent(s), then such Recipient's rights granted under Section 2(b) shall terminate as of the date such litigation is filed.

All Recipient's rights under this Agreement shall terminate if it fails to comply with any of the material terms or conditions of this Agreement and does not cure such failure in a reasonable period of time after becoming aware of such noncompliance. If all Recipient's rights under this Agreement terminate, Recipient agrees to cease use and distribution of the Program as soon as reasonably practicable. However, Recipient's obligations under this Agreement and any licenses granted by Recipient relating to the Program shall continue and survive.

Everyone is permitted to copy and distribute copies of this Agreement, but in order to avoid inconsistency the Agreement is copyrighted and may only be modified in the following manner. The Agreement Steward reserves the right to publish new versions (including revisions) of this Agreement from time to time. No one other than the Agreement Steward has the right to modify this Agreement. The Eclipse Foundation is the initial Agreement Steward. The Eclipse Foundation may assign the responsibility to serve as the Agreement Steward to a suitable separate entity. Each new version of the Agreement will be given a distinguishing version number. The Program (including Contributions) may always be distributed subject to the version of the Agreement under which it was received. In addition, after a new version of the Agreement is published, Contributor may elect to distribute the Program (including its Contributions) under the new version. Except as expressly stated in Sections 2(a) and 2(b) above, Recipient receives no rights or licenses to the intellectual property of any Contributor under this Agreement, whether expressly, by implication, estoppel or otherwise. All rights in the Program not expressly granted under this Agreement are reserved.

This Agreement is governed by the laws of the State of New York and the intellectual property laws of the United States of America. No party to this Agreement will bring a legal action under this Agreement more than one year after the cause of action arose. Each party waives its rights to a jury trial in any resulting litigation.

For the Windows Installer component:

\* All NSIS source code, plug-ins, documentation, examples, header files and graphics, with the exception of the compression modules and where otherwise noted, are licensed under the zlib/libpng license.

\* The zlib compression module for NSIS is licensed under the zlib/libpng license.

\* The bzip2 compression module for NSIS is licensed under the bzip2 license.

\* The lzma compression module for NSIS is licensed under the Common Public License version 1.0.

#### zlib/libpng license

This software is provided 'as-is', without any express or implied warranty. In no event will the authors be held liable for any damages arising from the use of this software.

Permission is granted to anyone to use this software for any purpose, including commercial applications, and to alter it and redistribute it freely, subject to the following restrictions:

1. The origin of this software must not be misrepresented; you must not claim that you wrote the original software. If you use this software in a product, an acknowledgment in the product documentation would be appreciated but is not required.
2. Altered source versions must be plainly marked as such, and must not be misrepresented as being the original software.
3. This notice may not be removed or altered from any source distribution.

#### bzip2 license

Redistribution and use in source and binary forms, with or without modification, are permitted provided that the following conditions are met:

1. Redistributions of source code must retain the above copyright notice, this list of conditions and the following disclaimer.
2. The origin of this software must not be misrepresented; you must not claim that you wrote the original software. If you use this software in a product, an acknowledgment in the product documentation would be appreciated but is not required.
3. Altered source versions must be plainly marked as such, and must not be misrepresented as being the original software.
4. The name of the author may not be used to endorse or promote products derived from this software without specific prior written permission.

THIS SOFTWARE IS PROVIDED BY THE AUTHOR ``AS IS AND ANY EXPRESS OR IMPLIED WARRANTIES, INCLUDING, BUT NOT LIMITED TO, THE IMPLIED WARRANTIES OF MERCHANTABILITY AND FITNESS FOR A PARTICULAR PURPOSE ARE DISCLAIMED. IN NO EVENT SHALL THE AUTHOR BE LIABLE FOR ANY DIRECT, INDIRECT, INCIDENTAL, SPECIAL, EXEMPLARY, OR CONSEQUENTIAL DAMAGES (INCLUDING, BUT NOT LIMITED TO, PROCUREMENT OF SUBSTITUTE GOODS OR SERVICES; LOSS OF USE, DATA, OR PROFITS; OR BUSINESS INTERRUPTION) HOWEVER CAUSED AND ON ANY THEORY OF LIABILITY, WHETHER IN CONTRACT, STRICT LIABILITY, OR TORT (INCLUDING NEGLIGENCE OR OTHERWISE) ARISING IN ANY WAY OUT OF THE USE OF THIS SOFTWARE, EVEN IF ADVISED OF THE POSSIBILITY OF SUCH DAMAGE.

Julian Seward, Cambridge, UK.

[jseward@acm.org](mailto:jseward@acm.org)

Common Public License version 1.0

THE ACCOMPANYING PROGRAM IS PROVIDED UNDER THE TERMS OF THIS COMMON PUBLIC LICENSE ("AGREEMENT"). ANY USE, REPRODUCTION OR DISTRIBUTION OF THE PROGRAM CONSTITUTES RECIPIENT'S ACCEPTANCE OF THIS AGREEMENT.

## 1. DEFINITIONS

"Contribution" means:

a) in the case of the initial Contributor, the initial code and documentation distributed under this Agreement, and b) in the case of each subsequent Contributor:

i) changes to the Program, and

ii) additions to the Program;

where such changes and/or additions to the Program originate from and are distributed by that particular Contributor. A Contribution 'originates' from a Contributor if it was added to the Program by such Contributor itself or anyone acting on such Contributor's behalf. Contributions do not include additions to the Program which: (i) are separate modules of software distributed in conjunction with the Program under their own license agreement, and (ii) are not derivative works of the Program.

"Contributor" means any person or entity that distributes the Program.

"Licensed Patents " mean patent claims licensable by a Contributor which are necessarily infringed by the use or sale of its Contribution alone or when combined with the Program.

"Program" means the Contributions distributed in accordance with this Agreement.

"Recipient" means anyone who receives the Program under this Agreement, including all Contributors.

## 2. GRANT OF RIGHTS

a) Subject to the terms of this Agreement, each Contributor hereby grants Recipient a non-exclusive, worldwide, royalty-free copyright license to reproduce, prepare derivative works of, publicly display, publicly perform, distribute and sublicense the Contribution of such Contributor, if any, and such derivative works, in source code and object code form.

b) Subject to the terms of this Agreement, each Contributor hereby grants Recipient a non-exclusive, worldwide, royalty-free patent license under Licensed Patents to make, use, sell, offer to sell, import and otherwise transfer the Contribution of such Contributor, if any, in source code and object code form. This patent license shall apply to the combination of the Contribution and the Program if, at the time the Contribution is added by the Contributor, such addition of the Contribution causes such combination to be covered by the Licensed Patents. The patent license shall not apply to any other combinations which include the Contribution. No hardware per se is licensed hereunder.

c) Recipient understands that although each Contributor grants the licenses to its Contributions set forth herein, no assurances are provided by any Contributor that the Program does not infringe the patent or other intellectual property

rights of any other entity. Each Contributor disclaims any liability to Recipient for claims brought by any other entity based on infringement of intellectual property rights or otherwise. As a condition to exercising the rights and licenses granted hereunder, each Recipient hereby assumes sole responsibility to secure any other intellectual property rights needed, if any. For example, if a third party patent license is required to allow Recipient to distribute the Program, it is Recipient's responsibility to acquire that license before distributing the Program.

d) Each Contributor represents that to its knowledge it has sufficient copyright rights in its Contribution, if any, to grant the copyright license set forth in this Agreement.

### 3. REQUIREMENTS

A Contributor may choose to distribute the Program in object code form under its own license agreement, provided that:

a) it complies with the terms and conditions of this Agreement; and

b) its license agreement:

i) effectively disclaims on behalf of all Contributors all warranties and conditions, express and implied, including warranties or conditions of title and non-infringement, and implied warranties or conditions of merchantability and fitness for a particular purpose;

ii) effectively excludes on behalf of all Contributors all liability for damages, including direct, indirect, special, incidental and consequential damages, such as lost profits;

iii) states that any provisions which differ from this Agreement are offered by that Contributor alone and not by any other party; and

iv) states that source code for the Program is available from such Contributor, and informs licensees how to obtain it in a reasonable manner on or through a medium customarily used for software exchange.

When the Program is made available in source code form:

a) it must be made available under this Agreement; and

b) a copy of this Agreement must be included with each copy of the Program.

Contributors may not remove or alter any copyright notices contained within the Program.

Each Contributor must identify itself as the originator of its Contribution, if any, in a manner that reasonably allows subsequent Recipients to identify the originator of the Contribution.

### 4. COMMERCIAL DISTRIBUTION

Commercial distributors of software may accept certain responsibilities with respect to end users, business partners and the like. While this license is intended to facilitate the commercial use of the Program, the Contributor who includes the Program in a commercial product offering should do so in a manner which does not create potential liability for other Contributors. Therefore, if a Contributor includes the Program in a commercial product offering, such Contributor



("Commercial Contributor") hereby agrees to defend and indemnify every other Contributor ("Indemnified Contributor") against any losses, damages and costs (collectively "Losses") arising from claims, lawsuits and other legal actions brought by a third party against the Indemnified Contributor to the extent caused by the acts or omissions of such Commercial Contributor in connection with its distribution of the Program in a commercial product offering. The obligations in this section do not apply to any claims or Losses relating to any actual or alleged intellectual property infringement. In order to qualify, an Indemnified Contributor must: a) promptly notify the Commercial Contributor in writing of such claim, and b) allow the Commercial Contributor to control, and cooperate with the Commercial Contributor in, the defense and any related settlement negotiations. The Indemnified Contributor may participate in any such claim at its own expense.

For example, a Contributor might include the Program in a commercial product offering, Product X. That Contributor is then a Commercial Contributor. If that Commercial Contributor then makes performance claims, or offers warranties related to Product X, those performance claims and warranties are such Commercial Contributor's responsibility alone. Under this section, the Commercial Contributor would have to defend claims against the other Contributors related to those performance claims and warranties, and if a court requires any other Contributor to pay any damages as a result, the Commercial Contributor must pay those damages.

#### 5. NO WARRANTY

EXCEPT AS EXPRESSLY SET FORTH IN THIS AGREEMENT, THE PROGRAM IS PROVIDED ON AN "AS IS" BASIS, WITHOUT WARRANTIES OR CONDITIONS OF ANY KIND, EITHER EXPRESS OR IMPLIED INCLUDING, WITHOUT LIMITATION, ANY WARRANTIES OR CONDITIONS OF TITLE, NON-INFRINGEMENT, MERCHANTABILITY OR FITNESS FOR A PARTICULAR PURPOSE. Each Recipient is solely responsible for determining the appropriateness of using and distributing the Program and assumes all risks associated with its exercise of rights under this Agreement, including but not limited to the risks and costs of program errors, compliance with applicable laws, damage to or loss of data, programs or equipment, and unavailability or interruption of operations.

#### 6. DISCLAIMER OF LIABILITY

EXCEPT AS EXPRESSLY SET FORTH IN THIS AGREEMENT, NEITHER RECIPIENT NOR ANY CONTRIBUTORS SHALL HAVE ANY LIABILITY FOR ANY DIRECT, INDIRECT, INCIDENTAL, SPECIAL, EXEMPLARY, OR CONSEQUENTIAL DAMAGES (INCLUDING WITHOUT LIMITATION LOST PROFITS), HOWEVER CAUSED AND ON ANY THEORY OF LIABILITY, WHETHER IN CONTRACT, STRICT LIABILITY, OR TORT (INCLUDING NEGLIGENCE OR OTHERWISE) ARISING IN ANY WAY OUT OF THE USE OR DISTRIBUTION OF THE PROGRAM OR THE EXERCISE OF ANY RIGHTS GRANTED HEREUNDER, EVEN IF ADVISED OF THE POSSIBILITY OF SUCH DAMAGES.

#### 7. GENERAL

If any provision of this Agreement is invalid or unenforceable under applicable law, it shall not affect the validity or enforceability of the remainder of the terms of this Agreement, and without further action by the parties hereto, such provision shall be reformed to the minimum extent necessary to make such provision valid and enforceable.

If Recipient institutes patent litigation against a Contributor with respect to a



patent applicable to software (including a cross-claim or counterclaim in a lawsuit), then any patent licenses granted by that Contributor to such Recipient under this Agreement shall terminate as of the date such litigation is filed. In addition, if Recipient institutes patent litigation against any entity (including a cross-claim or counterclaim in a lawsuit) alleging that the Program itself (excluding combinations of the Program with other software or hardware) infringes such Recipient's patent(s), then such Recipient's rights granted under Section 2(b) shall terminate as of the date such litigation is filed.

All Recipient's rights under this Agreement shall terminate if it fails to comply with any of the material terms or conditions of this Agreement and does not cure such failure in a reasonable period of time after becoming aware of such noncompliance. If all Recipient's rights under this Agreement terminate, Recipient agrees to cease use and distribution of the Program as soon as reasonably practicable. However, Recipient's obligations under this Agreement and any licenses granted by Recipient relating to the Program shall continue and survive.

Everyone is permitted to copy and distribute copies of this Agreement, but in order to avoid inconsistency the Agreement is copyrighted and may only be modified in the following manner. The Agreement Steward reserves the right to publish new versions (including revisions) of this Agreement from time to time. No one other than the Agreement Steward has the right to modify this Agreement. IBM is the initial Agreement Steward. IBM may assign the responsibility to serve as the Agreement Steward to a suitable separate entity. Each new version of the Agreement will be given a distinguishing version number. The Program (including Contributions) may always be distributed subject to the version of the Agreement under which it was received. In addition, after a new version of the Agreement is published, Contributor may elect to distribute the Program (including its Contributions) under the new version. Except as expressly stated in Sections 2(a) and 2(b) above, Recipient receives no rights or licenses to the intellectual property of any Contributor under this Agreement, whether expressly, by implication, estoppel or otherwise. All rights in the Program not expressly granted under this Agreement are reserved.

This Agreement is governed by the laws of the State of New York and the intellectual property laws of the United States of America. No party to this Agreement will bring a legal action under this Agreement more than one year after the cause of action arose. Each party waives its rights to a jury trial in any resulting litigation.

Special exception for LZMA compression module

Igor Pavlov and Amir Szekely, the authors of the LZMA compression module for NSIS, expressly permit you to statically or dynamically link your code (or bind by name) to the files from the LZMA compression module for NSIS without subjecting your linked code to the terms of the Common Public license version 1.0. Any modifications or additions to files from the LZMA compression module for NSIS, however, are subject to the terms of the Common Public License version 1.0.

For the following XML Schemas for Java EE Deployment Descriptors:

- javaee\_5.xsd
- javaee\_web\_services\_1\_2.xsd
- javaee\_web\_services\_client\_1\_2.xsd
- javaee\_6.xsd
- javaee\_web\_services\_1\_3.xsd
- javaee\_web\_services\_client\_1\_3.xsd
- jsp\_2\_2.xsd

- web-app\_3\_0.xsd
- web-common\_3\_0.xsd
- web-fragment\_3\_0.xsd

## COMMON DEVELOPMENT AND DISTRIBUTION LICENSE (CDDL) Version 1.0

### 1. Definitions.

1.1. Contributor. means each individual or entity that creates or contributes to the creation of Modifications.

1.2. Contributor Version. means the combination of the Original Software, prior Modifications used by a Contributor (if any), and the Modifications made by that particular Contributor.

1.3. Covered Software. means (a) the Original Software, or (b) Modifications, or (c) the combination of files containing Original Software with files containing Modifications, in each case including portions thereof.

1.4. Executable. means the Covered Software in any form other than Source Code.

1.5. Initial Developer. means the individual or entity that first makes Original Software available under this License.

1.6. Larger Work. means a work which combines Covered Software or portions thereof with code not governed by the terms of this License.

1.7. License. means this document.

1.8. Licensable. means having the right to grant, to the maximum extent possible, whether at the time of the initial grant or subsequently acquired, any and all of the rights conveyed herein.

1.9. Modifications. means the Source Code and Executable form of any of the following:

A. Any file that results from an addition to, deletion from or modification of the contents of a file containing Original Software or previous Modifications;

B. Any new file that contains any part of the Original Software or previous Modification; or

C. Any new file that is contributed or otherwise made available under the terms of this License.

1.10. Original Software. means the Source Code and Executable form of computer software code that is originally released under this License.

1.11. Patent Claims. means any patent claim(s), now owned or hereafter acquired, including without limitation, method, process, and apparatus claims, in any patent Licensable by grantor.

1.12. Source Code. means (a) the common form of computer software code in which modifications are made and (b) associated documentation included in or with such code.

1.13. You. (or .Your.) means an individual or a legal entity exercising rights under,

and complying with all of the terms of, this License. For legal entities, .You. includes any entity which controls, is controlled by, or is under common control with You. For purposes of this definition, .control. means (a) the power, direct or indirect, to cause the direction or management of such entity, whether by contract or otherwise, or (b) ownership of more than fifty percent (50%) of the outstanding shares or beneficial ownership of such entity.

## 2. License Grants.

### 2.1. The Initial Developer Grant.

Conditioned upon Your compliance with Section 3.1 below and subject to third party intellectual property claims, the Initial Developer hereby grants You a world-wide, royalty-free, non-exclusive license:

(a) under intellectual property rights (other than patent or trademark) Licensable by Initial Developer, to use, reproduce, modify, display, perform, sublicense and distribute the Original Software (or portions thereof), with or without Modifications, and/or as part of a Larger Work; and

(b) under Patent Claims infringed by the making, using or selling of Original Software, to make, have made, use, practice, sell, and offer for sale, and/or otherwise dispose of the Original Software (or portions thereof).

(c) The licenses granted in Sections 2.1(a) and (b) are effective on the date Initial Developer first distributes or otherwise makes the Original Software available to a third party under the terms of this License.

(d) Notwithstanding Section 2.1(b) above, no patent license is granted: (1) for code that You delete from the Original Software, or (2) for infringements caused by: (i) the modification of the Original Software, or (ii) the combination of the Original Software with other software or devices.

### 2.2. Contributor Grant.

Conditioned upon Your compliance with Section 3.1 below and subject to third party intellectual property claims, each Contributor hereby grants You a world-wide, royalty-free, non-exclusive license:

(a) under intellectual property rights (other than patent or trademark) Licensable by Contributor to use, reproduce, modify, display, perform, sublicense and distribute the Modifications created by such Contributor (or portions thereof), either on an unmodified basis, with other Modifications, as Covered Software and/or as part of a Larger Work; and

(b) under Patent Claims infringed by the making, using, or selling of Modifications made by that Contributor either alone and/or in combination with its Contributor Version (or portions of such combination), to make, use, sell, offer for sale, have made, and/or otherwise dispose of: (1) Modifications made by that Contributor (or portions thereof); and (2) the combination of Modifications made by that Contributor with its Contributor Version (or portions of such combination).

(c) The licenses granted in Sections 2.2(a) and 2.2(b) are effective on the date Contributor first distributes or otherwise makes the Modifications available to a third party.

(d) Notwithstanding Section 2.2(b) above, no patent license is granted: (1) for any code that Contributor has deleted from the Contributor Version; (2) for

infringements caused by: (i) third party modifications of Contributor Version, or (ii) the combination of Modifications made by that Contributor with other software (except as part of the Contributor Version) or other devices; or (3) under Patent Claims infringed by Covered Software in the absence of Modifications made by that Contributor.

### 3. Distribution Obligations.

#### 3.1. Availability of Source Code.

Any Covered Software that You distribute or otherwise make available in Executable form must also be made available in Source Code form and that Source Code form must be distributed only under the terms of this License. You must include a copy of this License with every copy of the Source Code form of the Covered Software You distribute or otherwise make available. You must inform recipients of any such Covered Software in Executable form as to how they can obtain such Covered Software in Source Code form in a reasonable manner on or through a medium customarily used for software exchange.

#### 3.2. Modifications.

The Modifications that You create or to which You contribute are governed by the terms of this License. You represent that You believe Your Modifications are Your original creation(s) and/or You have sufficient rights to grant the rights conveyed by this License.

#### 3.3. Required Notices.

You must include a notice in each of Your Modifications that identifies You as the Contributor of the Modification. You may not remove or alter any copyright, patent or trademark notices contained within the Covered Software, or any notices of licensing or any descriptive text giving attribution to any Contributor or the Initial Developer.

#### 3.4. Application of Additional Terms.

You may not offer or impose any terms on any Covered Software in Source Code form that alters or restricts the applicable version of this License or the recipients' rights hereunder. You may choose to offer, and to charge a fee for, warranty, support, indemnity or liability obligations to one or more recipients of Covered Software. However, you may do so only on Your own behalf, and not on behalf of the Initial Developer or any Contributor. You must make it absolutely clear that any such warranty, support, indemnity or liability obligation is offered by You alone, and You hereby agree to indemnify the Initial Developer and every Contributor for any liability incurred by the Initial Developer or such Contributor as a result of warranty, support, indemnity or liability terms You offer.

#### 3.5. Distribution of Executable Versions.

You may distribute the Executable form of the Covered Software under the terms of this License or under the terms of a license of Your choice, which may contain terms different from this License, provided that You are in compliance with the terms of this License and that the license for the Executable form does not attempt to limit or alter the recipient's rights in the Source Code form from the rights set forth in this License. If You distribute the Covered Software in Executable form under a different license, You must make it absolutely clear that any terms which differ from this License are offered by You alone, not by the Initial Developer or Contributor. You hereby agree to indemnify the Initial Developer and every Contributor for any liability incurred by the Initial Developer or such Contributor as a result of any such terms You offer.

#### 3.6. Larger Works.

You may create a Larger Work by combining Covered Software with other code

not governed by the terms of this License and distribute the Larger Work as a single product. In such a case, You must make sure the requirements of this License are fulfilled for the Covered Software.

#### 4. Versions of the License.

##### 4.1. New Versions.

Sun Microsystems, Inc. is the initial license steward and may publish revised and/or new versions of this License from time to time. Each version will be given a distinguishing version number. Except as provided in Section 4.3, no one other than the license steward has the right to modify this License.

##### 4.2. Effect of New Versions.

You may always continue to use, distribute or otherwise make the Covered Software available under the terms of the version of the License under which You originally received the Covered Software. If the Initial Developer includes a notice in the Original Software prohibiting it from being distributed or otherwise made available under any subsequent version of the License, You must distribute and make the Covered Software available under the terms of the version of the License under which You originally received the Covered Software. Otherwise, You may also choose to use, distribute or otherwise make the Covered Software available under the terms of any subsequent version of the License published by the license steward.

##### 4.3. Modified Versions.

When You are an Initial Developer and You want to create a new license for Your Original Software, You may create and use a modified version of this License if You: (a) rename the license and remove any references to the name of the license steward (except to note that the license differs from this License); and (b) otherwise make it clear that the license contains terms which differ from this License.

#### 5. DISCLAIMER OF WARRANTY.

COVERED SOFTWARE IS PROVIDED UNDER THIS LICENSE ON AN .AS IS. BASIS, WITHOUT WARRANTY OF ANY KIND, EITHER EXPRESSED OR IMPLIED, INCLUDING, WITHOUT LIMITATION, WARRANTIES THAT THE COVERED SOFTWARE IS FREE OF DEFECTS, MERCHANTABLE, FIT FOR A PARTICULAR PURPOSE OR NON-INFRINGEMENT. THE ENTIRE RISK AS TO THE QUALITY AND PERFORMANCE OF THE COVERED SOFTWARE IS WITH YOU. SHOULD ANY COVERED SOFTWARE PROVE DEFECTIVE IN ANY RESPECT, YOU (NOT THE INITIAL DEVELOPER OR ANY OTHER CONTRIBUTOR) ASSUME THE COST OF ANY NECESSARY SERVICING, REPAIR OR CORRECTION. THIS DISCLAIMER OF WARRANTY CONSTITUTES AN ESSENTIAL PART OF THIS LICENSE. NO USE OF ANY COVERED SOFTWARE IS AUTHORIZED HEREUNDER EXCEPT UNDER THIS DISCLAIMER.

#### 6. TERMINATION.

6.1. This License and the rights granted hereunder will terminate automatically if You fail to comply with terms herein and fail to cure such breach within 30 days of becoming aware of the breach. Provisions which, by their nature, must remain in effect beyond the termination of this License shall survive.

6.2. If You assert a patent infringement claim (excluding declaratory judgment actions) against Initial Developer or a Contributor (the Initial Developer or Contributor against whom You assert such claim is referred to as .Participant.) alleging that the Participant Software (meaning the Contributor Version where the

Participant is a Contributor or the Original Software where the Participant is the Initial Developer) directly or indirectly infringes any patent, then any and all rights granted directly or indirectly to You by such Participant, the Initial Developer (if the Initial Developer is not the Participant) and all Contributors under Sections 2.1 and/or 2.2 of this License shall, upon 60 days notice from Participant terminate prospectively and automatically at the expiration of such 60 day notice period, unless if within such 60 day period You withdraw Your claim with respect to the Participant Software against such Participant either unilaterally or pursuant to a written agreement with Participant.

6.3. In the event of termination under Sections 6.1 or 6.2 above, all end user licenses that have been validly granted by You or any distributor hereunder prior to termination (excluding licenses granted to You by any distributor) shall survive termination.

## 7. LIMITATION OF LIABILITY.

UNDER NO CIRCUMSTANCES AND UNDER NO LEGAL THEORY, WHETHER TORT (INCLUDING NEGLIGENCE), CONTRACT, OR OTHERWISE, SHALL YOU, THE INITIAL DEVELOPER, ANY OTHER CONTRIBUTOR, OR ANY DISTRIBUTOR OF COVERED SOFTWARE, OR ANY SUPPLIER OF ANY OF SUCH PARTIES, BE LIABLE TO ANY PERSON FOR ANY INDIRECT, SPECIAL, INCIDENTAL, OR CONSEQUENTIAL DAMAGES OF ANY CHARACTER INCLUDING, WITHOUT LIMITATION, DAMAGES FOR LOST PROFITS, LOSS OF GOODWILL, WORK STOPPAGE, COMPUTER FAILURE OR MALFUNCTION, OR ANY AND ALL OTHER COMMERCIAL DAMAGES OR LOSSES, EVEN IF SUCH PARTY SHALL HAVE BEEN INFORMED OF THE POSSIBILITY OF SUCH DAMAGES. THIS LIMITATION OF LIABILITY SHALL NOT APPLY TO LIABILITY FOR DEATH OR PERSONAL INJURY RESULTING FROM SUCH PARTY'S NEGLIGENCE TO THE EXTENT APPLICABLE LAW PROHIBITS SUCH LIMITATION. SOME JURISDICTIONS DO NOT ALLOW THE EXCLUSION OR LIMITATION OF INCIDENTAL OR CONSEQUENTIAL DAMAGES, SO THIS EXCLUSION AND LIMITATION MAY NOT APPLY TO YOU.

## 8. U.S. GOVERNMENT END USERS.

The Covered Software is a .commercial item,. as that term is defined in 48 C.F.R. 2.101 (Oct. 1995), consisting of .commercial computer software. (as that term is defined at 48 C.F.R. ? 252.227-7014(a)(1)) and commercial computer software documentation. as such terms are used in 48 C.F.R. 12.212 (Sept. 1995). Consistent with 48 C.F.R. 12.212 and 48 C.F.R. 227.7202-1 through 227.7202-4 (June 1995), all U.S. Government End Users acquire Covered Software with only those rights set forth herein. This U.S. Government Rights clause is in lieu of, and supersedes, any other FAR, DFAR, or other clause or provision that addresses Government rights in computer software under this License.

## 9. MISCELLANEOUS.

This License represents the complete agreement concerning subject matter hereof. If any provision of this License is held to be unenforceable, such provision shall be reformed only to the extent necessary to make it enforceable. This License shall be governed by the law of the jurisdiction specified in a notice contained within the Original Software (except to the extent applicable law, if any, provides otherwise), excluding such jurisdiction's conflict-of-law provisions. Any litigation relating to this License shall be subject to the jurisdiction of the courts located in the jurisdiction and venue specified in a notice contained within the Original Software, with the losing party responsible for costs, including, without limitation, court costs and reasonable attorneys. fees and expenses. The application of the United Nations Convention on Contracts for the International Sale of Goods is

expressly excluded. Any law or regulation which provides that the language of a contract shall be construed against the drafter shall not apply to this License. You agree that You alone are responsible for compliance with the United States export administration regulations (and the export control laws and regulation of any other countries) when You use, distribute or otherwise make available any Covered Software.

#### 10. RESPONSIBILITY FOR CLAIMS.

As between Initial Developer and the Contributors, each party is responsible for claims and damages arising, directly or indirectly, out of its utilization of rights under this License and You agree to work with Initial Developer and Contributors to distribute such responsibility on an equitable basis. Nothing herein is intended or shall be deemed to constitute any admission of liability.

#### NOTICE PURSUANT TO SECTION 9 OF THE COMMON DEVELOPMENT AND DISTRIBUTION LICENSE (CDDL)

The code released under the CDDL shall be governed by the laws of the State of California (excluding conflict-of-law provisions). Any litigation relating to this License shall be subject to the jurisdiction of the Federal Courts of the Northern District of California and the state courts of the State of California, with venue lying in Santa Clara County, California.

## □ Apache Ant 1.9.3

Copyright 1999-2012 The Apache Software Foundation

The <sync> task is based on code Copyright (c) 2002, Landmark Graphics Corp that has been kindly donated to the Apache Software Foundation.

Apache License  
Version 2.0, January 2004  
<http://www.apache.org/licenses/>

#### TERMS AND CONDITIONS FOR USE, REPRODUCTION, AND DISTRIBUTION

##### 1. Definitions.

"License" shall mean the terms and conditions for use, reproduction, and distribution as defined by Sections 1 through 9 of this document.

"Licensor" shall mean the copyright owner or entity authorized by the copyright owner that is granting the License.

"Legal Entity" shall mean the union of the acting entity and all other entities that control, are controlled by, or are under common control with that entity. For the purposes of this definition, "control" means (i) the power, direct or indirect, to cause the direction or management of such entity, whether by contract or otherwise, or (ii) ownership of fifty percent (50%) or more of the outstanding shares, or (iii) beneficial ownership of such entity.

"You" (or "Your") shall mean an individual or Legal Entity exercising permissions granted by this License.

"Source" form shall mean the preferred form for making modifications, including but not limited to software source code, documentation source, and configuration files.



"Object" form shall mean any form resulting from mechanical transformation or translation of a Source form, including but not limited to compiled object code, generated documentation, and conversions to other media types.

"Work" shall mean the work of authorship, whether in Source or Object form, made available under the License, as indicated by a copyright notice that is included in or attached to the work (an example is provided in the Appendix below).

"Derivative Works" shall mean any work, whether in Source or Object form, that is based on (or derived from) the Work and for which the editorial revisions, annotations, elaborations, or other modifications represent, as a whole, an original work of authorship. For the purposes of this License, Derivative Works shall not include works that remain separable from, or merely link (or bind by name) to the interfaces of, the Work and Derivative Works thereof.

"Contribution" shall mean any work of authorship, including the original version of the Work and any modifications or additions to that Work or Derivative Works thereof, that is intentionally submitted to Licensor for inclusion in the Work by the copyright owner or by an individual or Legal Entity authorized to submit on behalf of the copyright owner. For the purposes of this definition, "submitted" means any form of electronic, verbal, or written communication sent to the Licensor or its representatives, including but not limited to communication on electronic mailing lists, source code control systems, and issue tracking systems that are managed by, or on behalf of, the Licensor for the purpose of discussing and improving the Work, but excluding communication that is conspicuously marked or otherwise designated in writing by the copyright owner as "Not a Contribution."

"Contributor" shall mean Licensor and any individual or Legal Entity on behalf of whom a Contribution has been received by Licensor and subsequently incorporated within the Work.

2. Grant of Copyright License. Subject to the terms and conditions of this License, each Contributor hereby grants to You a perpetual, worldwide, non-exclusive, no-charge, royalty-free, irrevocable copyright license to reproduce, prepare Derivative Works of, publicly display, publicly perform, sublicense, and distribute the Work and such Derivative Works in Source or Object form.

3. Grant of Patent License. Subject to the terms and conditions of this License, each Contributor hereby grants to You a perpetual, worldwide, non-exclusive, no-charge, royalty-free, irrevocable (except as stated in this section) patent license to make, have made, use, offer to sell, sell, import, and otherwise transfer the Work, where such license applies only to those patent claims licensable by such Contributor that are necessarily infringed by their Contribution(s) alone or by combination of their Contribution(s) with the Work to which such Contribution(s) was submitted. If You institute patent litigation against any entity (including a cross-claim or counterclaim in a lawsuit) alleging that the Work or a Contribution incorporated within the Work constitutes direct or contributory patent infringement, then any patent licenses granted to You under this License for that Work shall terminate as of the date such litigation is filed.

4. Redistribution. You may reproduce and distribute copies of the Work or Derivative Works thereof in any medium, with or without modifications, and in Source or Object form, provided that You meet the following conditions:

(a) You must give any other recipients of the Work or Derivative Works a copy of this License; and



(b) You must cause any modified files to carry prominent notices stating that You changed the files; and

(c) You must retain, in the Source form of any Derivative Works that You distribute, all copyright, patent, trademark, and attribution notices from the Source form of the Work, excluding those notices that do not pertain to any part of the Derivative Works; and

(d) If the Work includes a "NOTICE" text file as part of its distribution, then any Derivative Works that You distribute must include a readable copy of the attribution notices contained within such NOTICE file, excluding those notices that do not pertain to any part of the Derivative Works, in at least one of the following places: within a NOTICE text file distributed as part of the Derivative Works; within the Source form or documentation, if provided along with the Derivative Works; or, within a display generated by the Derivative Works, if and wherever such third-party notices normally appear. The contents of the NOTICE file are for informational purposes only and do not modify the License. You may add Your own attribution notices within Derivative Works that You distribute, alongside or as an addendum to the NOTICE text from the Work, provided that such additional attribution notices cannot be construed as modifying the License.

You may add Your own copyright statement to Your modifications and may provide additional or different license terms and conditions for use, reproduction, or distribution of Your modifications, or for any such Derivative Works as a whole, provided Your use, reproduction, and distribution of the Work otherwise complies with the conditions stated in this License.

5. Submission of Contributions. Unless You explicitly state otherwise, any Contribution intentionally submitted for inclusion in the Work by You to the Licensor shall be under the terms and conditions of this License, without any additional terms or conditions. Notwithstanding the above, nothing herein shall supersede or modify the terms of any separate license agreement you may have executed with Licensor regarding such Contributions.

6. Trademarks. This License does not grant permission to use the trade names, trademarks, service marks, or product names of the Licensor, except as required for reasonable and customary use in describing the origin of the Work and reproducing the content of the NOTICE file.

7. Disclaimer of Warranty. Unless required by applicable law or agreed to in writing, Licensor provides the Work (and each Contributor provides its Contributions) on an "AS IS" BASIS, WITHOUT WARRANTIES OR CONDITIONS OF ANY KIND, either express or implied, including, without limitation, any warranties or conditions of TITLE, NON-INFRINGEMENT, MERCHANTABILITY, or FITNESS FOR A PARTICULAR PURPOSE. You are solely responsible for determining the appropriateness of using or redistributing the Work and assume any risks associated with Your exercise of permissions under this License.

8. Limitation of Liability. In no event and under no legal theory, whether in tort (including negligence), contract, or otherwise, unless required by applicable law (such as deliberate and grossly negligent acts) or agreed to in writing, shall any Contributor be liable to You for damages, including any direct, indirect, special, incidental, or consequential damages of any character arising as a result of this License or out of the use or inability to use the Work (including but not limited to damages for loss of goodwill, work stoppage, computer failure or malfunction, or any and all other commercial damages or losses), even if such Contributor has been advised of the possibility of such damages.

9. Accepting Warranty or Additional Liability. While redistributing the Work or Derivative Works thereof, You may choose to offer, and charge a fee for, acceptance of support, warranty, indemnity, or other liability obligations and/or rights consistent with this License. However, in accepting such obligations, You may act only on Your own behalf and on Your sole responsibility, not on behalf of any other Contributor, and only if You agree to indemnify, defend, and hold each Contributor harmless for any liability incurred by, or claims asserted against, such Contributor by reason of your accepting any such warranty or additional liability.

## END OF TERMS AND CONDITIONS

APPENDIX: How to apply the Apache License to your work.

To apply the Apache License to your work, attach the following boilerplate notice, with the fields enclosed by brackets "[ ]" replaced with your own identifying information. (Don't include the brackets!) The text should be enclosed in the appropriate comment syntax for the file format. We also recommend that a file or class name and description of purpose be included on the same "printed page" as the copyright notice for easier identification within third-party archives.

Copyright [yyyy] [name of copyright owner]

Licensed under the Apache License, Version 2.0 (the "License"); you may not use this file except in compliance with the License. You may obtain a copy of the License at

<http://www.apache.org/licenses/LICENSE-2.0>

Unless required by applicable law or agreed to in writing, software distributed under the License is distributed on an "AS IS" BASIS, WITHOUT WARRANTIES OR CONDITIONS OF ANY KIND, either express or implied. See the License for the specific language governing permissions and limitations under the License.

## ❑ rotatelogs

Apache License  
Version 2.0, January 2004  
<http://www.apache.org/licenses/>

### TERMS AND CONDITIONS FOR USE, REPRODUCTION, AND DISTRIBUTION

#### 1. Definitions.

"License" shall mean the terms and conditions for use, reproduction, and distribution as defined by Sections 1 through 9 of this document.

"Licensor" shall mean the copyright owner or entity authorized by the copyright owner that is granting the License.

"Legal Entity" shall mean the union of the acting entity and all other entities that control, are controlled by, or are under common control with that entity. For the purposes of this definition, "control" means (i) the power, direct or indirect, to cause the direction or management of such entity, whether by contract or otherwise, or (ii) ownership of fifty percent (50%) or more of the outstanding shares, or (iii) beneficial ownership of such entity.

"You" (or "Your") shall mean an individual or Legal Entity exercising permissions

granted by this License.

"Source" form shall mean the preferred form for making modifications, including but not limited to software source code, documentation source, and configuration files.

"Object" form shall mean any form resulting from mechanical transformation or translation of a Source form, including but not limited to compiled object code, generated documentation, and conversions to other media types.

"Work" shall mean the work of authorship, whether in Source or Object form, made available under the License, as indicated by a copyright notice that is included in or attached to the work (an example is provided in the Appendix below).

"Derivative Works" shall mean any work, whether in Source or Object form, that is based on (or derived from) the Work and for which the editorial revisions, annotations, elaborations, or other modifications represent, as a whole, an original work of authorship. For the purposes of this License, Derivative Works shall not include works that remain separable from, or merely link (or bind by name) to the interfaces of, the Work and Derivative Works thereof.

"Contribution" shall mean any work of authorship, including the original version of the Work and any modifications or additions to that Work or Derivative Works thereof, that is intentionally submitted to Licensor for inclusion in the Work by the copyright owner or by an individual or Legal Entity authorized to submit on behalf of the copyright owner. For the purposes of this definition, "submitted" means any form of electronic, verbal, or written communication sent to the Licensor or its representatives, including but not limited to communication on electronic mailing lists, source code control systems, and issue tracking systems that are managed by, or on behalf of, the Licensor for the purpose of discussing and improving the Work, but excluding communication that is conspicuously marked or otherwise designated in writing by the copyright owner as "Not a Contribution."

"Contributor" shall mean Licensor and any individual or Legal Entity on behalf of whom a Contribution has been received by Licensor and subsequently incorporated within the Work.

2. Grant of Copyright License. Subject to the terms and conditions of this License, each Contributor hereby grants to You a perpetual, worldwide, non-exclusive, no-charge, royalty-free, irrevocable copyright license to reproduce, prepare Derivative Works of, publicly display, publicly perform, sublicense, and distribute the Work and such Derivative Works in Source or Object form.

3. Grant of Patent License. Subject to the terms and conditions of this License, each Contributor hereby grants to You a perpetual, worldwide, non-exclusive, no-charge, royalty-free, irrevocable (except as stated in this section) patent license to make, have made, use, offer to sell, sell, import, and otherwise transfer the Work, where such license applies only to those patent claims licensable by such Contributor that are necessarily infringed by their Contribution(s) alone or by combination of their Contribution(s) with the Work to which such Contribution(s) was submitted. If You institute patent litigation against any entity (including a cross-claim or counterclaim in a lawsuit) alleging that the Work or a Contribution incorporated within the Work constitutes direct or contributory patent infringement, then any patent licenses granted to You under this License for that Work shall terminate as of the date such litigation is filed.

4. Redistribution. You may reproduce and distribute copies of the Work or

Derivative Works thereof in any medium, with or without modifications, and in Source or Object form, provided that You meet the following conditions:

- a. You must give any other recipients of the Work or Derivative Works a copy of this License; and
- b. You must cause any modified files to carry prominent notices stating that You changed the files; and
- c. You must retain, in the Source form of any Derivative Works that You distribute, all copyright, patent, trademark, and attribution notices from the Source form of the Work, excluding those notices that do not pertain to any part of the Derivative Works; and
- d. If the Work includes a "NOTICE" text file as part of its distribution, then any Derivative Works that You distribute must include a readable copy of the attribution notices contained within such NOTICE file, excluding those notices that do not pertain to any part of the Derivative Works, in at least one of the following places: within a NOTICE text file distributed as part of the Derivative Works; within the Source form or documentation, if provided along with the Derivative Works; or, within a display generated by the Derivative Works, if and wherever such third-party notices normally appear. The contents of the NOTICE file are for informational purposes only and do not modify the License. You may add Your own attribution notices within Derivative Works that You distribute, alongside or as an addendum to the NOTICE text from the Work, provided that such additional attribution notices cannot be construed as modifying the License.

You may add Your own copyright statement to Your modifications and may provide additional or different license terms and conditions for use, reproduction, or distribution of Your modifications, or for any such Derivative Works as a whole, provided Your use, reproduction, and distribution of the Work otherwise complies with the conditions stated in this License.

5. Submission of Contributions. Unless You explicitly state otherwise, any Contribution intentionally submitted for inclusion in the Work by You to the Licensor shall be under the terms and conditions of this License, without any additional terms or conditions. Notwithstanding the above, nothing herein shall supersede or modify the terms of any separate license agreement you may have executed with Licensor regarding such Contributions.

6. Trademarks. This License does not grant permission to use the trade names, trademarks, service marks, or product names of the Licensor, except as required for reasonable and customary use in describing the origin of the Work and reproducing the content of the NOTICE file.

7. Disclaimer of Warranty. Unless required by applicable law or agreed to in writing, Licensor provides the Work (and each Contributor provides its Contributions) on an "AS IS" BASIS, WITHOUT WARRANTIES OR CONDITIONS OF ANY KIND, either express or implied, including, without limitation, any warranties or conditions of TITLE, NON-INFRINGEMENT, MERCHANTABILITY, or FITNESS FOR A PARTICULAR PURPOSE. You are solely responsible for determining the appropriateness of using or redistributing the Work and assume any risks associated with Your exercise of permissions under this License.

8. Limitation of Liability. In no event and under no legal theory, whether in tort (including negligence), contract, or otherwise, unless required by applicable law (such as deliberate and grossly negligent acts) or agreed to in writing, shall any Contributor be liable to You for damages, including any direct, indirect, special, incidental, or consequential damages of any character arising as a result of this License or out of the use or inability to use the Work (including but not limited to damages for loss of goodwill, work stoppage, computer failure or malfunction, or any and all other commercial damages or losses), even if such Contributor has

been advised of the possibility of such damages.

9. Accepting Warranty or Additional Liability. While redistributing the Work or Derivative Works thereof, You may choose to offer, and charge a fee for, acceptance of support, warranty, indemnity, or other liability obligations and/or rights consistent with this License. However, in accepting such obligations, You may act only on Your own behalf and on Your sole responsibility, not on behalf of any other Contributor, and only if You agree to indemnify, defend, and hold each Contributor harmless for any liability incurred by, or claims asserted against, such Contributor by reason of your accepting any such warranty or additional liability.

END OF TERMS AND CONDITIONS

APPENDIX: How to apply the Apache License to your work

To apply the Apache License to your work, attach the following boilerplate notice, with the fields enclosed by brackets "[]" replaced with your own identifying information. (Don't include the brackets!) The text should be enclosed in the appropriate comment syntax for the file format. We also recommend that a file or class name and description of purpose be included on the same "printed page" as the copyright notice for easier identification within third-party archives.

Copyright [yyyy] [name of copyright owner]

Licensed under the Apache License, Version 2.0 (the "License"); you may not use this file except in compliance with the License. You may obtain a copy of the License at

<http://www.apache.org/licenses/LICENSE-2.0>

Unless required by applicable law or agreed to in writing, software distributed under the License is distributed on an "AS IS" BASIS, WITHOUT WARRANTIES OR CONDITIONS OF ANY KIND, either express or implied. See the License for the specific language governing permissions and limitations under the License.

## ❑ vsftpd 2.3.5

vsftpd is licensed under version 2 of the GNU GPL.

As copyright holder, I give permission for vsftpd to be linked to the OpenSSL libraries. This includes permission for vsftpd binaries to be distributed linked against the OpenSSL libraries. All other obligations under the GPL v2 remain intact.

GNU GENERAL PUBLIC LICENSE  
Version 2, June 1991

Copyright (C) 1989, 1991 Free Software Foundation, Inc. 59 Temple Place, Suite 330, Boston, MA 02111-1307 USA

Everyone is permitted to copy and distribute verbatim copies of this license document, but changing it is not allowed.

Preamble

The licenses for most software are designed to take away your freedom to share and change it. By contrast, the GNU General Public License is intended to guarantee your freedom to share and change free software--to make sure the software is free for all its users. This General Public License applies to most of the Free Software Foundation's software and to any other program whose authors

commit to using it. (Some other Free Software Foundation software is covered by the GNU Library General Public License instead.) You can apply it to your programs, too.

When we speak of free software, we are referring to freedom, not price. Our General Public Licenses are designed to make sure that you have the freedom to distribute copies of free software (and charge for this service if you wish), that you receive source code or can get it if you want it, that you can change the software or use pieces of it in new free programs; and that you know you can do these things.

To protect your rights, we need to make restrictions that forbid anyone to deny you these rights or to ask you to surrender the rights. These restrictions translate to certain responsibilities for you if you distribute copies of the software, or if you modify it.

For example, if you distribute copies of such a program, whether gratis or for a fee, you must give the recipients all the rights that you have. You must make sure that they, too, receive or can get the source code. And you must show them these terms so they know their rights.

We protect your rights with two steps: (1) copyright the software, and (2) offer you this license which gives you legal permission to copy, distribute and/or modify the software.

Also, for each author's protection and ours, we want to make certain that everyone understands that there is no warranty for this free software. If the software is modified by someone else and passed on, we want its recipients to know that what they have is not the original, so that any problems introduced by others will not reflect on the original authors' reputations.

Finally, any free program is threatened constantly by software patents. We wish to avoid the danger that redistributors of a free program will individually obtain patent licenses, in effect making the program proprietary. To prevent this, we have made it clear that any patent must be licensed for everyone's free use or not licensed at all.

The precise terms and conditions for copying, distribution and modification follow.

#### GNU GENERAL PUBLIC LICENSE TERMS AND CONDITIONS FOR COPYING, DISTRIBUTION AND MODIFICATION

0. This License applies to any program or other work which contains a notice placed by the copyright holder saying it may be distributed under the terms of this General Public License. The "Program", below, refers to any such program or work, and a "work based on the Program" means either the Program or any derivative work under copyright law:

that is to say, a work containing the Program or a portion of it, either verbatim or with modifications and/or translated into another language. (Hereinafter, translation is included without limitation in the term "modification".) Each licensee is addressed as "you".

Activities other than copying, distribution and modification are not covered by this License; they are outside its scope. The act of running the Program is not restricted, and the output from the Program is covered only if its contents constitute a work based on the Program (independent of having been made by running the Program). Whether that is true depends on what the Program does.



1. You may copy and distribute verbatim copies of the Program's source code as you receive it, in any medium, provided that you conspicuously and appropriately publish on each copy an appropriate copyright notice and disclaimer of warranty; keep intact all the notices that refer to this License and to the absence of any warranty; and give any other recipients of the Program a copy of this License along with the Program.

You may charge a fee for the physical act of transferring a copy, and you may at your option offer warranty protection in exchange for a fee.

2. You may modify your copy or copies of the Program or any portion of it, thus forming a work based on the Program, and copy and distribute such modifications or work under the terms of Section 1 above, provided that you also meet all of these conditions:

a) You must cause the modified files to carry prominent notices stating that you changed the files and the date of any change.

b) You must cause any work that you distribute or publish, that in whole or in part contains or is derived from the Program or any part thereof, to be licensed as a whole at no charge to all third parties under the terms of this License.

c) If the modified program normally reads commands interactively when run, you must cause it, when started running for such interactive use in the most ordinary way, to print or display an announcement including an appropriate copyright notice and a notice that there is no warranty (or else, saying that you provide a warranty) and that users may redistribute the program under these conditions, and telling the user how to view a copy of this License. (Exception: if the Program itself is interactive but does not normally print such an announcement, your work based on the Program is not required to print an announcement.)

These requirements apply to the modified work as a whole. If identifiable sections of that work are not derived from the Program, and can be reasonably considered independent and separate works in themselves, then this License, and its terms, do not apply to those sections when you distribute them as separate works. But when you distribute the same sections as part of a whole which is a work based on the Program, the distribution of the whole must be on the terms of this License, whose permissions for other licensees extend to the entire whole, and thus to each and every part regardless of who wrote it.

Thus, it is not the intent of this section to claim rights or contest your rights to work written entirely by you; rather, the intent is to exercise the right to control the distribution of derivative or collective works based on the Program.

In addition, mere aggregation of another work not based on the Program with the Program (or with a work based on the Program) on a volume of a storage or distribution medium does not bring the other work under the scope of this License.

3. You may copy and distribute the Program (or a work based on it, under Section 2) in object code or executable form under the terms of Sections 1 and 2 above provided that you also do one of the following:

a) Accompany it with the complete corresponding machine-readable source code, which must be distributed under the terms of Sections 1 and 2 above on a medium customarily used for software interchange; or,

b) Accompany it with a written offer, valid for at least three years, to give any

third party, for a charge no more than your cost of physically performing source distribution, a complete machine-readable copy of the corresponding source code, to be distributed under the terms of Sections 1 and 2 above on a medium customarily used for software interchange; or,

c) Accompany it with the information you received as to the offer to distribute corresponding source code. (This alternative is allowed only for noncommercial distribution and only if you received the program in object code or executable form with such an offer, in accord with Subsection b above.)

The source code for a work means the preferred form of the work for making modifications to it. For an executable work, complete source code means all the source code for all modules it contains, plus any associated interface definition files, plus the scripts used to control compilation and installation of the executable. However, as a special exception, the source code distributed need not include anything that is normally distributed (in either source or binary form) with the major components (compiler, kernel, and so on) of the operating system on which the executable runs, unless that component itself accompanies the executable.

If distribution of executable or object code is made by offering access to copy from a designated place, then offering equivalent access to copy the source code from the same place counts as distribution of the source code, even though third parties are not compelled to copy the source along with the object code.

4. You may not copy, modify, sublicense, or distribute the Program except as expressly provided under this License. Any attempt otherwise to copy, modify, sublicense or distribute the Program is void, and will automatically terminate your rights under this License. However, parties who have received copies, or rights, from you under this License will not have their licenses terminated so long as such parties remain in full compliance.

5. You are not required to accept this License, since you have not signed it. However, nothing else grants you permission to modify or distribute the Program or its derivative works. These actions are prohibited by law if you do not accept this License. Therefore, by modifying or distributing the Program (or any work based on the Program), you indicate your acceptance of this License to do so, and all its terms and conditions for copying, distributing or modifying the Program or works based on it.

6. Each time you redistribute the Program (or any work based on the Program), the recipient automatically receives a license from the original licensor to copy, distribute or modify the Program subject to these terms and conditions. You may not impose any further restrictions on the recipients' exercise of the rights granted herein. You are not responsible for enforcing compliance by third parties to this License.

7. If, as a consequence of a court judgment or allegation of patent infringement or for any other reason (not limited to patent issues), conditions are imposed on you (whether by court order, agreement or otherwise) that contradict the conditions of this License, they do not excuse you from the conditions of this License. If you cannot distribute so as to satisfy simultaneously your obligations under this License and any other pertinent obligations, then as a consequence you may not distribute the Program at all. For example, if a patent license would not permit royalty-free redistribution of the Program by all those who receive copies directly or indirectly through you, then the only way you could satisfy both it and this License would be to refrain entirely from distribution of the Program.

If any portion of this section is held invalid or unenforceable under any particular



circumstance, the balance of the section is intended to apply and the section as a whole is intended to apply in other circumstances.

It is not the purpose of this section to induce you to infringe any patents or other property right claims or to contest validity of any such claims; this section has the sole purpose of protecting the integrity of the free software distribution system, which is implemented by public license practices. Many people have made generous contributions to the wide range of software distributed through that system in reliance on consistent application of that system; it is up to the author/donor to decide if he or she is willing to distribute software through any other system and a licensee cannot impose that choice.

This section is intended to make thoroughly clear what is believed to be a consequence of the rest of this License.

8. If the distribution and/or use of the Program is restricted in certain countries either by patents or by copyrighted interfaces, the original copyright holder who places the Program under this License may add an explicit geographical distribution limitation excluding those countries, so that distribution is permitted only in or among countries not thus excluded. In such case, this License incorporates the limitation as if written in the body of this License.

9. The Free Software Foundation may publish revised and/or new versions of the General Public License from time to time. Such new versions will be similar in spirit to the present version, but may differ in detail to address new problems or concerns.

Each version is given a distinguishing version number. If the Program specifies a version number of this License which applies to it and "any later version", you have the option of following the terms and conditions either of that version or of any later version published by the Free Software Foundation. If the Program does not specify a version number of this License, you may choose any version ever published by the Free Software Foundation.

10. If you wish to incorporate parts of the Program into other free programs whose distribution conditions are different, write to the author to ask for permission. For software which is copyrighted by the Free Software Foundation, write to the Free Software Foundation; we sometimes make exceptions for this. Our decision will be guided by the two goals of preserving the free status of all derivatives of our free software and of promoting the sharing and reuse of software generally.

#### NO WARRANTY

11. BECAUSE THE PROGRAM IS LICENSED FREE OF CHARGE, THERE IS NO WARRANTY FOR THE PROGRAM, TO THE EXTENT PERMITTED BY APPLICABLE LAW. EXCEPT WHEN OTHERWISE STATED IN WRITING THE COPYRIGHT HOLDERS AND/OR OTHER PARTIES PROVIDE THE PROGRAM "AS IS" WITHOUT WARRANTY OF ANY KIND, EITHER EXPRESSED OR IMPLIED, INCLUDING, BUT NOT LIMITED TO, THE IMPLIED WARRANTIES OF MERCHANTABILITY AND FITNESS FOR A PARTICULAR PURPOSE. THE ENTIRE RISK AS TO THE QUALITY AND PERFORMANCE OF THE PROGRAM IS WITH YOU. SHOULD THE PROGRAM PROVE DEFECTIVE, YOU ASSUME THE COST OF ALL NECESSARY SERVICING, REPAIR OR CORRECTION.

12. IN NO EVENT UNLESS REQUIRED BY APPLICABLE LAW OR AGREED TO IN WRITING WILL ANY COPYRIGHT HOLDER, OR ANY OTHER PARTY WHO MAY MODIFY AND/OR REDISTRIBUTE THE PROGRAM AS PERMITTED ABOVE,

BE LIABLE TO YOU FOR DAMAGES, INCLUDING ANY GENERAL, SPECIAL, INCIDENTAL OR CONSEQUENTIAL DAMAGES ARISING OUT OF THE USE OR INABILITY TO USE THE PROGRAM (INCLUDING BUT NOT LIMITED TO LOSS OF DATA OR DATA BEING RENDERED INACCURATE OR LOSSES SUSTAINED BY YOU OR THIRD PARTIES OR A FAILURE OF THE PROGRAM TO OPERATE WITH ANY OTHER PROGRAMS), EVEN IF SUCH HOLDER OR OTHER PARTY HAS BEEN ADVISED OF THE POSSIBILITY OF SUCH DAMAGES.

## □ OpenSSL 1.0.1E

### LICENSE ISSUES

The OpenSSL toolkit stays under a dual license, i.e. both the conditions of the OpenSSL License and the original SSLeay license apply to the toolkit. See below for the actual license texts.

### OpenSSL License

Copyright (c) 1998-2016 The OpenSSL Project. All rights reserved.

Redistribution and use in source and binary forms, with or without modification, are permitted provided that the following conditions are met:

1. Redistributions of source code must retain the above copyright notice, this list of conditions and the following disclaimer.

2. Redistributions in binary form must reproduce the above copyright notice, this list of conditions and the following disclaimer in the documentation and/or other materials provided with the distribution.

3. All advertising materials mentioning features or use of this software must display the following acknowledgment:

"This product includes software developed by the OpenSSL Project for use in the OpenSSL Toolkit. (<http://www.openssl.org/>)"

4. The names "OpenSSL Toolkit" and "OpenSSL Project" must not be used to endorse or promote products derived from this software without prior written permission. For written permission, please contact [openssl-core@openssl.org](mailto:openssl-core@openssl.org).

5. Products derived from this software may not be called "OpenSSL" nor may "OpenSSL" appear in their names without prior written permission of the OpenSSL Project.

6. Redistributions of any form whatsoever must retain the following acknowledgment: "This product includes software developed by the OpenSSL Project for use in the OpenSSL Toolkit (<http://www.openssl.org/>)"

THIS SOFTWARE IS PROVIDED BY THE OpenSSL PROJECT "AS IS" AND ANY EXPRESSED OR IMPLIED WARRANTIES, INCLUDING, BUT NOT LIMITED TO, THE IMPLIED WARRANTIES OF MERCHANTABILITY AND FITNESS FOR A PARTICULAR PURPOSE ARE DISCLAIMED. IN NO EVENT SHALL THE OpenSSL PROJECT OR ITS CONTRIBUTORS BE LIABLE FOR ANY DIRECT, INDIRECT, INCIDENTAL, SPECIAL, EXEMPLARY, OR CONSEQUENTIAL DAMAGES (INCLUDING, BUT NOT LIMITED TO, PROCUREMENT OF SUBSTITUTE GOODS OR SERVICES; LOSS OF USE, DATA, OR PROFITS; OR BUSINESS INTERRUPTION) HOWEVER CAUSED AND ON ANY THEORY OF LIABILITY, WHETHER IN CONTRACT, STRICT LIABILITY, OR TORT (INCLUDING NEGLIGENCE OR OTHERWISE) ARISING IN ANY WAY OUT OF THE USE OF THIS SOFTWARE, EVEN IF ADVISED OF THE POSSIBILITY OF SUCH DAMAGE.

This product includes cryptographic software written by Eric Young (eay@cryptsoft.com). This product includes software written by Tim Hudson (tjh@cryptsoft.com).

Original SSLeay License  
Copyright (C) 1995-1998 Eric Young (eay@cryptsoft.com)  
All rights reserved.

This package is an SSL implementation written by Eric Young (eay@cryptsoft.com). The implementation was written so as to conform with Netscapes SSL.

This library is free for commercial and non-commercial use as long as the following conditions are adhered to. The following conditions apply to all code found in this distribution, be it the RC4, RSA, lhash, DES, etc., code; not just the SSL code. The SSL documentation included with this distribution is covered by the same copyright terms except that the holder is Tim Hudson (tjh@cryptsoft.com).

Copyright remains Eric Young's, and as such any Copyright notices in the code are not to be removed.

If this package is used in a product, Eric Young should be given attribution as the author of the parts of the library used.

This can be in the form of a textual message at program startup or in documentation (online or textual) provided with the package.

Redistribution and use in source and binary forms, with or without modification, are permitted provided that the following conditions are met:

1. Redistributions of source code must retain the copyright notice, this list of conditions and the following disclaimer.

2. Redistributions in binary form must reproduce the above copyright notice, this list of conditions and the following disclaimer in the documentation and/or other materials provided with the distribution.

3. All advertising materials mentioning features or use of this software must display the following acknowledgement:

"This product includes cryptographic software written by Eric Young (eay@cryptsoft.com)"

The word 'cryptographic' can be left out if the routines from the library being used are not cryptographic related :-).

4. If you include any Windows specific code (or a derivative thereof) from the apps directory (application code) you must include an acknowledgement:

"This product includes software written by Tim Hudson (tjh@cryptsoft.com)"

THIS SOFTWARE IS PROVIDED BY ERIC YOUNG "AS IS" AND ANY EXPRESS OR IMPLIED WARRANTIES, INCLUDING, BUT NOT LIMITED TO, THE IMPLIED WARRANTIES OF MERCHANTABILITY AND FITNESS FOR A PARTICULAR PURPOSE ARE DISCLAIMED. IN NO EVENT SHALL THE AUTHOR OR CONTRIBUTORS BE LIABLE FOR ANY DIRECT, INDIRECT, INCIDENTAL, SPECIAL, EXEMPLARY, OR CONSEQUENTIAL DAMAGES (INCLUDING, BUT NOT LIMITED TO, PROCUREMENT OF SUBSTITUTE GOODS OR SERVICES; LOSS OF USE, DATA, OR PROFITS; OR BUSINESS INTERRUPTION) HOWEVER CAUSED AND ON ANY THEORY OF LIABILITY, WHETHER IN CONTRACT, STRICT LIABILITY, OR TORT (INCLUDING NEGLIGENCE OR OTHERWISE) ARISING IN ANY WAY OUT OF THE USE OF THIS SOFTWARE, EVEN IF ADVISED OF THE POSSIBILITY OF SUCH DAMAGE.

The licence and distribution terms for any publically available version or derivative of this code cannot be changed. i.e. this code cannot simply be copied and put under another distribution licence [including the GNU Public Licence.]

## □ Linux 3.0.35-imx

GNU GENERAL PUBLIC LICENSE  
Version 2, June 1991

Copyright (C) 1989, 1991 Free Software Foundation, Inc. 51 Franklin St, Fifth Floor, Boston, MA 02110-1301 USA

Everyone is permitted to copy and distribute verbatim copies of this license document, but changing it is not allowed.

Preamble

The licenses for most software are designed to take away your freedom to share and change it. By contrast, the GNU General Public License is intended to guarantee your freedom to share and change free software--to make sure the software is free for all its users. This General Public License applies to most of the Free Software Foundation's software and to any other program whose authors commit to using it. (Some other Free Software Foundation software is covered by the GNU Library General Public License instead.) You can apply it to your programs, too.

When we speak of free software, we are referring to freedom, not price. Our General Public Licenses are designed to make sure that you have the freedom to distribute copies of free software (and charge for this service if you wish), that you receive source code or can get it if you want it, that you can change the software or use pieces of it in new free programs; and that you know you can do these things.

To protect your rights, we need to make restrictions that forbid anyone to deny you these rights or to ask you to surrender the rights. These restrictions translate to certain responsibilities for you if you distribute copies of the software, or if you modify it.

For example, if you distribute copies of such a program, whether gratis or for a fee, you must give the recipients all the rights that you have. You must make sure that they, too, receive or can get the source code. And you must show them these terms so they know their rights.

We protect your rights with two steps: (1) copyright the software, and (2) offer you this license which gives you legal permission to copy, distribute and/or modify the software.

Also, for each author's protection and ours, we want to make certain that everyone understands that there is no warranty for this free software. If the software is modified by someone else and passed on, we want its recipients to know that what they have is not the original, so that any problems introduced by others will not reflect on the original authors' reputations.

Finally, any free program is threatened constantly by software patents. We wish to avoid the danger that redistributors of a free program will individually obtain patent licenses, in effect making the program proprietary. To prevent this, we have made it clear that any patent must be licensed for everyone's free use or not licensed at all.

The precise terms and conditions for copying, distribution and modification follow.

GNU GENERAL PUBLIC LICENSE

## TERMS AND CONDITIONS FOR COPYING, DISTRIBUTION AND MODIFICATION

0. This License applies to any program or other work which contains a notice placed by the copyright holder saying it may be distributed under the terms of this General Public License. The "Program", below, refers to any such program or work, and a "work based on the Program" means either the Program or any derivative work under copyright law: that is to say, a work containing the Program or a portion of it, either verbatim or with modifications and/or translated into another language. (Hereinafter, translation is included without limitation in the term "modification".) Each licensee is addressed as "you".

Activities other than copying, distribution and modification are not covered by this License; they are outside its scope. The act of running the Program is not restricted, and the output from the Program is covered only if its contents constitute a work based on the Program (independent of having been made by running the Program). Whether that is true depends on what the Program does.

1. You may copy and distribute verbatim copies of the Program's source code as you receive it, in any medium, provided that you conspicuously and appropriately publish on each copy an appropriate copyright notice and disclaimer of warranty; keep intact all the notices that refer to this License and to the absence of any warranty; and give any other recipients of the Program a copy of this License along with the Program.

You may charge a fee for the physical act of transferring a copy, and you may at your option offer warranty protection in exchange for a fee.

2. You may modify your copy or copies of the Program or any portion of it, thus forming a work based on the Program, and copy and distribute such modifications or work under the terms of Section 1 above, provided that you also meet all of these conditions:

a) You must cause the modified files to carry prominent notices stating that you changed the files and the date of any change.

b) You must cause any work that you distribute or publish, that in whole or in part contains or is derived from the Program or any part thereof, to be licensed as a whole at no charge to all third parties under the terms of this License.

c) If the modified program normally reads commands interactively when run, you must cause it, when started running for such interactive use in the most ordinary way, to print or display an announcement including an appropriate copyright notice and a notice that there is no warranty (or else, saying that you provide a warranty) and that users may redistribute the program under these conditions, and telling the user how to view a copy of this License. (Exception: if the Program itself is interactive but does not normally print such an announcement, your work based on the Program is not required to print an announcement.)

These requirements apply to the modified work as a whole. If identifiable sections of that work are not derived from the Program, and can be reasonably considered independent and separate works in themselves, then this License, and its terms, do not apply to those sections when you distribute them as separate works. But when you distribute the same sections as part of a whole which is a work based on the Program, the distribution of the whole must be on the terms of this License, whose permissions for other licensees extend to the entire whole, and thus to each and every part regardless of who wrote it.

Thus, it is not the intent of this section to claim rights or contest your rights to

work written entirely by you; rather, the intent is to exercise the right to control the distribution of derivative or collective works based on the Program.

In addition, mere aggregation of another work not based on the Program with the Program (or with a work based on the Program) on a volume of a storage or distribution medium does not bring the other work under the scope of this License.

3. You may copy and distribute the Program (or a work based on it, under Section 2) in object code or executable form under the terms of Sections 1 and 2 above provided that you also do one of the following:

a) Accompany it with the complete corresponding machine-readable source code, which must be distributed under the terms of Sections 1 and 2 above on a medium customarily used for software interchange; or,

b) Accompany it with a written offer, valid for at least three years, to give any third party, for a charge no more than your cost of physically performing source distribution, a complete machine-readable copy of the corresponding source code, to be distributed under the terms of Sections 1 and 2 above on a medium customarily used for software interchange; or,

c) Accompany it with the information you received as to the offer to distribute corresponding source code. (This alternative is allowed only for noncommercial distribution and only if you received the program in object code or executable form with such an offer, in accord with Subsection b above.)

The source code for a work means the preferred form of the work for making modifications to it. For an executable work, complete source code means all the source code for all modules it contains, plus any associated interface definition files, plus the scripts used to control compilation and installation of the executable. However, as a special exception, the source code distributed need not include anything that is normally distributed (in either source or binary form) with the major components (compiler, kernel, and so on) of the operating system on which the executable runs, unless that component itself accompanies the executable.

If distribution of executable or object code is made by offering access to copy from a designated place, then offering equivalent access to copy the source code from the same place counts as distribution of the source code, even though third parties are not compelled to copy the source along with the object code.

4. You may not copy, modify, sublicense, or distribute the Program except as expressly provided under this License. Any attempt otherwise to copy, modify, sublicense or distribute the Program is void, and will automatically terminate your rights under this License. However, parties who have received copies, or rights, from you under this License will not have their licenses terminated so long as such parties remain in full compliance.

5. You are not required to accept this License, since you have not signed it. However, nothing else grants you permission to modify or distribute the Program or its derivative works. These actions are prohibited by law if you do not accept this License. Therefore, by modifying or distributing the Program (or any work based on the Program), you indicate your acceptance of this License to do so, and all its terms and conditions for copying, distributing or modifying the Program or works based on it.

6. Each time you redistribute the Program (or any work based on the Program), the recipient automatically receives a license from the original licensor to copy,



distribute or modify the Program subject to these terms and conditions. You may not impose any further restrictions on the recipients' exercise of the rights granted herein. You are not responsible for enforcing compliance by third parties to this License.

7. If, as a consequence of a court judgment or allegation of patent infringement or for any other reason (not limited to patent issues), conditions are imposed on you (whether by court order, agreement or otherwise) that contradict the conditions of this License, they do not excuse you from the conditions of this License. If you cannot distribute so as to satisfy simultaneously your obligations under this License and any other pertinent obligations, then as a consequence you may not distribute the Program at all. For example, if a patent license would not permit royalty-free redistribution of the Program by all those who receive copies directly or indirectly through you, then the only way you could satisfy both it and this License would be to refrain entirely from distribution of the Program.

If any portion of this section is held invalid or unenforceable under any particular circumstance, the balance of the section is intended to apply and the section as a whole is intended to apply in other circumstances.

It is not the purpose of this section to induce you to infringe any patents or other property right claims or to contest validity of any such claims; this section has the sole purpose of protecting the integrity of the free software distribution system, which is implemented by public license practices. Many people have made generous contributions to the wide range of software distributed through that system in reliance on consistent application of that system; it is up to the author/donor to decide if he or she is willing to distribute software through any other system and a licensee cannot impose that choice.

This section is intended to make thoroughly clear what is believed to be a consequence of the rest of this License.

8. If the distribution and/or use of the Program is restricted in certain countries either by patents or by copyrighted interfaces, the original copyright holder who places the Program under this License may add an explicit geographical distribution limitation excluding those countries, so that distribution is permitted only in or among countries not thus excluded. In such case, this License incorporates the limitation as if written in the body of this License.

9. The Free Software Foundation may publish revised and/or new versions of the General Public License from time to time. Such new versions will be similar in spirit to the present version, but may differ in detail to address new problems or concerns.

Each version is given a distinguishing version number. If the Program specifies a version number of this License which applies to it and "any later version", you have the option of following the terms and conditions either of that version or of any later version published by the Free Software Foundation. If the Program does not specify a version number of this License, you may choose any version ever published by the Free Software Foundation.

10. If you wish to incorporate parts of the Program into other free programs whose distribution conditions are different, write to the author to ask for permission. For software which is copyrighted by the Free Software Foundation, write to the Free Software Foundation; we sometimes make exceptions for this. Our decision will be guided by the two goals of preserving the free status of all derivatives of our free software and of promoting the sharing and reuse of software generally.

## NO WARRANTY

11. BECAUSE THE PROGRAM IS LICENSED FREE OF CHARGE, THERE IS NO WARRANTY FOR THE PROGRAM, TO THE EXTENT PERMITTED BY APPLICABLE LAW. EXCEPT WHEN OTHERWISE STATED IN WRITING THE COPYRIGHT HOLDERS AND/OR OTHER PARTIES PROVIDE THE PROGRAM "AS IS" WITHOUT WARRANTY OF ANY KIND, EITHER EXPRESSED OR IMPLIED, INCLUDING, BUT NOT LIMITED TO, THE IMPLIED WARRANTIES OF MERCHANTABILITY AND FITNESS FOR A PARTICULAR PURPOSE. THE ENTIRE RISK AS TO THE QUALITY AND PERFORMANCE OF THE PROGRAM IS WITH YOU. SHOULD THE PROGRAM PROVE DEFECTIVE, YOU ASSUME THE COST OF ALL NECESSARY SERVICING, REPAIR OR CORRECTION.

12. IN NO EVENT UNLESS REQUIRED BY APPLICABLE LAW OR AGREED TO IN WRITING WILL ANY COPYRIGHT HOLDER, OR ANY OTHER PARTY WHO MAY MODIFY AND/OR REDISTRIBUTE THE PROGRAM AS PERMITTED ABOVE, BE LIABLE TO YOU FOR DAMAGES, INCLUDING ANY GENERAL, SPECIAL, INCIDENTAL OR CONSEQUENTIAL DAMAGES ARISING OUT OF THE USE OR INABILITY TO USE THE PROGRAM (INCLUDING BUT NOT LIMITED TO LOSS OF DATA OR DATA BEING RENDERED INACCURATE OR LOSSES SUSTAINED BY YOU OR THIRD PARTIES OR A FAILURE OF THE PROGRAM TO OPERATE WITH ANY OTHER PROGRAMS), EVEN IF SUCH HOLDER OR OTHER PARTY HAS BEEN ADVISED OF THE POSSIBILITY OF SUCH DAMAGES.

## □ java mail 1.4.7

Copyright 1999-2012 The Apache Software Foundation

The <sync> task is based on code Copyright (c) 2002, Landmark Graphics Corp that has been kindly donated to the Apache Software Foundation.

Oracle Corporation ("ORACLE") ENTITLEMENT for SOFTWARE

Licensee/Company: Entity receiving Software.

Effective Date: Date of delivery of the Software to You.

Software: JavaMail 1.4.4

License Term: Perpetual (subject to termination under the SLA).

Licensed Unit: Software Copy.

Licensed unit Count: Unlimited.

Permitted Uses:

1. You may reproduce and use the Software for Your own Individual, Commercial and Research and Instructional Use only for the purposes of designing, developing, testing, and running Your applets and applications ("Programs").

2. Subject to the terms and conditions of this Agreement and restrictions and exceptions set forth in the Software's documentation, You may reproduce and distribute portions of Software identified as a redistributable in the documentation (each a "Redistributable"), provided that You comply with the following (note that You may be entitled to reproduce and distribute other portions of the Software not defined in the documentation as a Redistributable under certain other licenses



as described in the THIRDPARTYLICENSEREADME, if applicable):

- (a) You distribute Redistributable complete and unmodified and only bundled as part of Your Programs,
- (b) Your Programs add significant and primary functionality to the Redistributable,
- (c) You distribute Redistributable for the sole purpose of running Your Programs,
- (d) You do not distribute additional software intended to replace any component(s) of the Redistributable,
- (e) You do not remove or alter any proprietary legends or notices contained in or on the Redistributable.
- (f) You only distribute the Redistributable subject to a license agreement that protects Oracle's interests consistent with the terms contained in this Agreement, and
- (g) You agree to defend and indemnify Oracle and its licensors from and against any damages, costs, liabilities, settlement amounts and/or expenses (including attorneys' fees) incurred in connection with any claim, lawsuit or action by any third party that arises or results from the use or distribution of any and all Programs and/or Redistributable.

3. Java Technology Restrictions. You may not create, modify, or change the behavior of, or authorize Your licensees to create, modify, or change the behavior of, classes, interfaces, or subpackages that are in any way identified as "java", "javax", "sun" or similar convention as specified by Oracle in any naming convention designation.

4. No Diagnostic, Maintenance, Repair or Technical Support Services. The scope of Your license does not include any right, express or implied, (i) to access, copy, distribute, display or use the Software to provide diagnostic, maintenance, repair or technical support services for Oracle software or Oracle hardware on behalf of any third party for Your direct or indirect commercial gain or advantage, without Oracle's prior written authorization, or (ii) for any third party to access, copy, distribute, display or use the Software to provide diagnostic, maintenance, repair or technical support services for Oracle software or Oracle hardware on Your behalf for such party's direct or indirect commercial gain or advantage, without Oracle's prior written authorization. The limitations set forth in this paragraph apply to any and all error corrections, patches, updates, and upgrades to the Software You may receive, access, download or otherwise obtain from Oracle.

5. Records and Documentation. During the term of the SLA and Entitlement, and for a period of three (3) years thereafter, You agree to keep proper records and documentation of Your compliance with the SLA and Entitlement. Upon Oracle's reasonable request, You will provide copies of such records and documentation to Oracle for the purpose of confirming Your compliance with the terms and conditions of the SLA and Entitlement. This section will survive any termination of the SLA and Entitlement. You may terminate this SLA and Entitlement at any time by destroying all copies of the Software in which case the obligations set forth in Section 7 of the SLA shall apply.

Oracle Corporation ("ORACLE") SOFTWARE LICENSE AGREEMENT

READ THE TERMS OF THIS AGREEMENT ("AGREEMENT") CAREFULLY BEFORE

OPENING SOFTWARE MEDIA PACKAGE. BY OPENING SOFTWARE MEDIA PACKAGE, YOU AGREE TO THE TERMS OF THIS AGREEMENT. IF YOU ARE ACCESSING SOFTWARE ELECTRONICALLY, INDICATE YOUR ACCEPTANCE OF THESE TERMS BY SELECTING THE "ACCEPT" BUTTON AT THE END OF THIS AGREEMENT. IF YOU DO NOT AGREE TO ALL OF THE TERMS, PROMPTLY RETURN THE UNUSED SOFTWARE TO YOUR PLACE OF PURCHASE FOR A REFUND OR, IF SOFTWARE IS ACCESSED ELECTRONICALLY, SELECT THE "DECLINE" (OR "EXIT") BUTTON AT THE END OF THIS AGREEMENT. IF YOU HAVE SEPARATELY AGREED TO LICENSE TERMS ("MASTER TERMS") FOR YOUR LICENSE TO THIS SOFTWARE, THEN SECTIONS 1-6 OF THIS AGREEMENT ("SUPPLEMENTAL LICENSE TERMS") SHALL SUPPLEMENT AND SUPERSEDE THE MASTER TERMS IN RELATION TO THIS SOFTWARE.

### 1. Definitions.

(a) "Entitlement" means the collective set of applicable documents authorized by Oracle evidencing your obligation to pay associated fees (if any) for the license, associated Services, and the authorized scope of use of Software under this Agreement.

(b) "Licensed Unit" means the unit of measure by which your use of Software and/or Service is licensed, as described in your Entitlement.

(c) "Permitted Use" means the licensed Software use(s) authorized in this Agreement as specified in your Entitlement. The Permitted Use for any bundled Oracle software not specified in your Entitlement will be evaluation use as provided in Section 3.

(d) "Service" means the service(s) that Oracle or its delegate will provide, if any, as selected in your Entitlement and as further described in the applicable service listings at [www.sun.com/service/servicelist](http://www.sun.com/service/servicelist).

(e) "Software" means the Oracle software described in your Entitlement. Also, certain software may be included for evaluation use under Section 3.

(f) "You" and "Your" means the individual or legal entity specified in the Entitlement, or for evaluation purposes, the entity performing the evaluation.

### 2. License Grant and Entitlement.

Subject to the terms of your Entitlement, Oracle grants you a nonexclusive, nontransferable limited license to use Software for its Permitted Use for the license term. Your Entitlement will specify (a) Software licensed, (b) the Permitted Use, (c) the license term, and (d) the Licensed Units.

Additionally, if your Entitlement includes Services, then it will also specify the (e) Service and (f) service term.

If your rights to Software or Services are limited in duration and the date such rights begin is other than the purchase date, your Entitlement will provide that beginning date(s).

The Entitlement may be delivered to you in various ways depending on the manner in which you obtain Software and Services, for example, the Entitlement may be provided in your receipt, invoice or your contract with Oracle or authorized Oracle reseller. It may also be in electronic format if you download Software.

### 3. Permitted Use.

As selected in your Entitlement, one or more of the following Permitted Uses will apply to your use of Software. Unless you have an Entitlement that expressly permits it, you may not use Software for any of the other Permitted Uses. If you don't have an Entitlement, or if your Entitlement doesn't cover additional software delivered to you, then such software is for your Evaluation Use.

(a) Evaluation Use. You may evaluate Software internally for a period of 90 days from your first use.

(b) Research and Instructional Use. You may use Software internally to design, develop and test, and also to provide instruction on such uses.

(c) Individual Use. You may use Software internally for personal, individual use.

(d) Commercial Use. You may use Software internally for your own commercial purposes.

(e) Service Provider Use. You may make Software functionality accessible (but not by providing Software itself or through outsourcing services) to your end users in an extranet deployment, but not to your affiliated companies or to government agencies.

#### 4. Licensed Units.

Your Permitted Use is limited to the number of Licensed Units stated in your Entitlement. If you require additional Licensed Units, you will need additional Entitlement(s).

#### 5. Restrictions.

(a) The copies of Software provided to you under this Agreement are licensed, not sold, to you by Oracle. Oracle reserves all rights not expressly granted.

(b) You may make a single archival copy of Software, but otherwise may not copy, modify, or distribute Software. However if the Oracle documentation accompanying Software lists specific portions of Software, such as header files, class libraries, reference source code, and/or redistributable files, that may be handled differently, you may do so only as provided in the Oracle documentation.

(c) You may not rent, lease, lend or encumber Software.

(d) Unless enforcement is prohibited by applicable law, you may not decompile, or reverse engineer Software.

(e) The terms and conditions of this Agreement will apply to any Software updates, provided to you at Oracle's discretion, that replace and/or supplement the original Software, unless such update contains a separate license.

(f) You may not publish or provide the results of any benchmark or comparison tests run on Software to any third party without the prior written consent of Oracle.

(g) Software is confidential and copyrighted.

(h) Unless otherwise specified, if Software is delivered with embedded or bundled software that enables functionality of Software, you may not use such software on a stand-alone basis or use any portion of such software to interoperate with

any program(s) other than Software.

(i) Software may contain programs that perform automated collection of system data and/or automated software updating services. System data collected through such programs may be used by Oracle, its subcontractors, and its service delivery partners for the purpose of providing you with remote system services and/or improving Oracle's software and systems.

(j) Software is not designed, licensed or intended for use in the design, construction, operation or maintenance of any nuclear facility and Oracle and its licensors disclaim any express or implied warranty of fitness for such uses.

(k) No right, title or interest in or to any trademark, service mark, logo or trade name of Oracle or its licensors is granted under this Agreement.

#### 6. Java Compatibility and Open Source.

Software may contain Java technology. You may not create additional classes to, or modifications of, the Java technology, except under compatibility requirements available under a separate agreement available at [www.java.net](http://www.java.net).

Oracle supports and benefits from the global community of open source developers, and thanks the community for its important contributions and open standards-based technology, which Oracle has adopted into many of its products.

Please note that portions of Software may be provided with notices and open source licenses from such communities and third parties that govern the use of those portions, and any licenses granted hereunder do not alter any rights and obligations you may have under such open source licenses, however, the disclaimer of warranty and limitation of liability provisions in this Agreement will apply to all Software in this distribution.

#### 7. Term and Termination.

The license and service term are set forth in your Entitlement(s). Your rights under this Agreement will terminate immediately without notice from Oracle if you materially breach it or take any action in derogation of Oracle's and/or its licensors' rights to Software. Oracle may terminate this Agreement should any Software become, or in Oracle's reasonable opinion likely to become, the subject of a claim of intellectual property infringement or trade secret misappropriation. Upon termination, you will cease use of, and destroy, Software and confirm compliance in writing to Oracle. Sections 1, 5, 6, 7, and 9-15 will survive termination of the Agreement.

#### 8. Limited Warranty.

Oracle warrants to you that for a period of 90 days from the date of purchase, as evidenced by a copy of the receipt, the media on which Software is furnished (if any) will be free of defects in materials and workmanship under normal use. Except for the foregoing, Software is provided "AS IS". Your exclusive remedy and Oracle's entire liability under this limited warranty will be at Oracle's option to replace Software media or refund the fee paid for Software. Some states do not allow limitations on certain implied warranties, so the above may not apply to you. This limited warranty gives you specific legal rights. You may have others, which vary from state to state.

#### 9. Disclaimer of Warranty.

UNLESS SPECIFIED IN THIS AGREEMENT, ALL EXPRESS OR IMPLIED CONDITIONS, REPRESENTATIONS AND WARRANTIES, INCLUDING ANY IMPLIED WARRANTY OF MERCHANTABILITY, FITNESS FOR A PARTICULAR PURPOSE OR NON-INFRINGEMENT ARE DISCLAIMED, EXCEPT TO THE EXTENT THAT THESE DISCLAIMERS ARE HELD TO BE LEGALLY INVALID.

#### 10. Limitation of Liability.

TO THE EXTENT NOT PROHIBITED BY LAW, IN NO EVENT WILL ORACLE OR ITS LICENSORS BE LIABLE FOR ANY LOST REVENUE, PROFIT OR DATA, OR FOR SPECIAL, INDIRECT, CONSEQUENTIAL, INCIDENTAL OR PUNITIVE DAMAGES, HOWEVER CAUSED REGARDLESS OF THE THEORY OF LIABILITY, ARISING OUT OF OR RELATED TO THE USE OF OR INABILITY TO USE SOFTWARE, EVEN IF ORACLE HAS BEEN ADVISED OF THE POSSIBILITY OF SUCH DAMAGES. In no event will Oracle's liability to you, whether in contract, tort (including negligence), or otherwise, exceed the amount paid by you for Software under this Agreement. The foregoing limitations will apply even if the above stated warranty fails of its essential purpose. Some states do not allow the exclusion of incidental or consequential damages, so some of the terms above may not be applicable to you.

#### 11. Export Regulations.

All Software, documents, technical data, and any other materials delivered under this Agreement are subject to U.S. export control laws and may be subject to export or import regulations in other countries. You agree to comply strictly with these laws and regulations and acknowledge that you have the responsibility to obtain any licenses to export, re-export, or import as may be required after delivery to you.

#### 12. U.S. Government Restricted Rights.

If Software is being acquired by or on behalf of the U.S. Government or by a U.S. Government prime contractor or subcontractor (at any tier), then the Government's rights in Software and accompanying documentation will be only as set forth in this Agreement; this is in accordance with 48 CFR 227.7201 through 227.7202-4 (for Department of Defense (DOD) acquisitions) and with 48 CFR 2.101 and 12.212 (for non-DOD acquisitions).

#### 13. Governing Law.

Any action related to this Agreement will be governed by California law and controlling U.S. federal law. No choice of law rules of any jurisdiction will apply.

#### 14. Severability.

If any provision of this Agreement is held to be unenforceable, this Agreement will remain in effect with the provision omitted, unless omission would frustrate the intent of the parties, in which case this Agreement will immediately terminate.

#### 15. Integration.

This Agreement, including any terms contained in your Entitlement, is the entire agreement between you and Oracle relating to its subject matter. It supersedes all prior or contemporaneous oral or written communications, proposals, representations and warranties and prevails over any conflicting or additional terms of any quote, order, acknowledgment, or other communication between the parties relating to its subject matter during the term of this Agreement. No

modification of this Agreement will be binding, unless in writing and signed by an authorized representative of each party.

For inquiries please contact: Oracle Corporation, 500 Oracle Parkway, Redwood Shores, California 94065, USA.

## □ H2 1.3.166

Eclipse Public License - v 1.0

THE ACCOMPANYING PROGRAM IS PROVIDED UNDER THE TERMS OF THIS ECLIPSE PUBLIC LICENSE ("AGREEMENT"). ANY USE, REPRODUCTION OR DISTRIBUTION OF THE PROGRAM CONSTITUTES Recipient's ACCEPTANCE OF THIS AGREEMENT.

### 1. DEFINITIONS

"Contribution" means:

- a) in the case of the initial Contributor, the initial code and documentation distributed under this Agreement, and
- b) in the case of each subsequent Contributor:

i) changes to the Program, and

ii) additions to the Program;

where such changes and/or additions to the Program originate from and are distributed by that particular Contributor. A Contribution 'originates' from a Contributor if it was added to the Program by such Contributor itself or anyone acting on such Contributor's behalf. Contributions do not include additions to the Program which: (i) are separate modules of software distributed in conjunction with the Program under their own license agreement, and (ii) are not derivative works of the Program.

"Contributor" means any person or entity that distributes the Program.

"Licensed Patents" mean patent claims licensable by a Contributor which are necessarily infringed by the use or sale of its Contribution alone or when combined with the Program.

"Program" means the Contributions distributed in accordance with this Agreement.

"Recipient" means anyone who receives the Program under this Agreement, including all Contributors.

### 2. GRANT OF RIGHTS

a) Subject to the terms of this Agreement, each Contributor hereby grants Recipient a non-exclusive, worldwide, royalty-free copyright license to reproduce, prepare derivative works of, publicly display, publicly perform, distribute and sublicense the Contribution of such Contributor, if any, and such derivative works, in source code and object code form.

b) Subject to the terms of this Agreement, each Contributor hereby grants Recipient a non-exclusive, worldwide, royalty-free patent license under Licensed Patents to make, use, sell, offer to sell, import and otherwise transfer the Contribution of such Contributor, if any, in source code and object code form.

This patent license shall apply to the combination of the Contribution and the Program if, at the time the Contribution is added by the Contributor, such addition of the Contribution causes such combination to be covered by the Licensed Patents. The patent license shall not apply to any other combinations which include the Contribution. No hardware per se is licensed hereunder.

c) Recipient understands that although each Contributor grants the licenses to its Contributions set forth herein, no assurances are provided by any Contributor that the Program does not infringe the patent or other intellectual property rights of any other entity. Each Contributor disclaims any liability to Recipient for claims brought by any other entity based on infringement of intellectual property rights or otherwise. As a condition to exercising the rights and licenses granted hereunder, each Recipient hereby assumes sole responsibility to secure any other intellectual property rights needed, if any. For example, if a third party patent license is required to allow Recipient to distribute the Program, it is Recipient's responsibility to acquire that license before distributing the Program.

d) Each Contributor represents that to its knowledge it has sufficient copyright rights in its Contribution, if any, to grant the copyright license set forth in this Agreement.

### 3. REQUIREMENTS

A Contributor may choose to distribute the Program in object code form under its own license agreement, provided that:

a) it complies with the terms and conditions of this Agreement; and

b) its license agreement:

i) effectively disclaims on behalf of all Contributors all warranties and conditions, express and implied, including warranties or conditions of title and non-infringement, and implied warranties or conditions of merchantability and fitness for a particular purpose;

ii) effectively excludes on behalf of all Contributors all liability for damages, including direct, indirect, special, incidental and consequential damages, such as lost profits;

iii) states that any provisions which differ from this Agreement are offered by that Contributor alone and not by any other party; and

iv) states that source code for the Program is available from such Contributor, and informs licensees how to obtain it in a reasonable manner on or through a medium customarily used for software exchange.

When the Program is made available in source code form:

a) it must be made available under this Agreement; and

b) a copy of this Agreement must be included with each copy of the Program.

Contributors may not remove or alter any copyright notices contained within the Program.

Each Contributor must identify itself as the originator of its Contribution, if any, in a manner that reasonably allows subsequent Recipients to identify the originator of the Contribution.



#### 4. COMMERCIAL DISTRIBUTION

Commercial distributors of software may accept certain responsibilities with respect to end users, business partners and the like. While this license is intended to facilitate the commercial use of the Program, the Contributor who includes the Program in a commercial product offering should do so in a manner which does not create potential liability for other Contributors. Therefore, if a Contributor includes the Program in a commercial product offering, such Contributor ("Commercial Contributor") hereby agrees to defend and indemnify every other Contributor ("Indemnified Contributor") against any losses, damages and costs (collectively "Losses") arising from claims, lawsuits and other legal actions brought by a third party against the Indemnified Contributor to the extent caused by the acts or omissions of such Commercial Contributor in connection with its distribution of the Program in a commercial product offering. The obligations in this section do not apply to any claims or Losses relating to any actual or alleged intellectual property infringement. In order to qualify, an Indemnified Contributor must: a) promptly notify the Commercial Contributor in writing of such claim, and b) allow the Commercial Contributor to control, and cooperate with the Commercial Contributor in, the defense and any related settlement negotiations. The Indemnified Contributor may participate in any such claim at its own expense.

For example, a Contributor might include the Program in a commercial product offering, Product X. That Contributor is then a Commercial Contributor. If that Commercial Contributor then makes performance claims, or offers warranties related to Product X, those performance claims and warranties are such Commercial Contributor's responsibility alone. Under this section, the Commercial Contributor would have to defend claims against the other Contributors related to those performance claims and warranties, and if a court requires any other Contributor to pay any damages as a result, the Commercial Contributor must pay those damages.

#### 5. NO WARRANTY

EXCEPT AS EXPRESSLY SET FORTH IN THIS AGREEMENT, THE PROGRAM IS PROVIDED ON AN "AS IS" BASIS, WITHOUT WARRANTIES OR CONDITIONS OF ANY KIND, EITHER EXPRESS OR IMPLIED INCLUDING, WITHOUT LIMITATION, ANY WARRANTIES OR CONDITIONS OF TITLE, NON-INFRINGEMENT, MERCHANTABILITY OR FITNESS FOR A PARTICULAR PURPOSE. Each Recipient is solely responsible for determining the appropriateness of using and distributing the Program and assumes all risks associated with its exercise of rights under this Agreement, including but not limited to the risks and costs of program errors, compliance with applicable laws, damage to or loss of data, programs or equipment, and unavailability or interruption of operations.

#### 6. DISCLAIMER OF LIABILITY

EXCEPT AS EXPRESSLY SET FORTH IN THIS AGREEMENT, NEITHER RECIPIENT NOR ANY CONTRIBUTORS SHALL HAVE ANY LIABILITY FOR ANY DIRECT, INDIRECT, INCIDENTAL, SPECIAL, EXEMPLARY, OR CONSEQUENTIAL DAMAGES (INCLUDING WITHOUT LIMITATION LOST PROFITS), HOWEVER CAUSED AND ON ANY THEORY OF LIABILITY, WHETHER IN CONTRACT, STRICT LIABILITY, OR TORT (INCLUDING NEGLIGENCE OR OTHERWISE) ARISING IN ANY WAY OUT OF THE USE OR DISTRIBUTION OF THE PROGRAM OR THE EXERCISE OF ANY RIGHTS GRANTED HEREUNDER, EVEN IF ADVISED OF THE POSSIBILITY OF SUCH DAMAGES.

#### 7. GENERAL



If any provision of this Agreement is invalid or unenforceable under applicable law, it shall not affect the validity or enforceability of the remainder of the terms of this Agreement, and without further action by the parties hereto, such provision shall be reformed to the minimum extent necessary to make such provision valid and enforceable.

If Recipient institutes patent litigation against any entity (including a cross-claim or counterclaim in a lawsuit) alleging that the Program itself (excluding combinations of the Program with other software or hardware) infringes such Recipient's patent(s), then such Recipient's rights granted under Section 2(b) shall terminate as of the date such litigation is filed.

All Recipient's rights under this Agreement shall terminate if it fails to comply with any of the material terms or conditions of this Agreement and does not cure such failure in a reasonable period of time after becoming aware of such noncompliance. If all Recipient's rights under this Agreement terminate, Recipient agrees to cease use and distribution of the Program as soon as reasonably practicable. However, Recipient's obligations under this Agreement and any licenses granted by Recipient relating to the Program shall continue and survive.

Everyone is permitted to copy and distribute copies of this Agreement, but in order to avoid inconsistency the Agreement is copyrighted and may only be modified in the following manner. The Agreement Steward reserves the right to publish new versions (including revisions) of this Agreement from time to time. No one other than the Agreement Steward has the right to modify this Agreement. The Eclipse Foundation is the initial Agreement Steward. The Eclipse Foundation may assign the responsibility to serve as the Agreement Steward to a suitable separate entity. Each new version of the Agreement will be given a distinguishing version number. The Program (including Contributions) may always be distributed subject to the version of the Agreement under which it was received. In addition, after a new version of the Agreement is published, Contributor may elect to distribute the Program (including its Contributions) under the new version. Except as expressly stated in Sections 2(a) and 2(b) above, Recipient receives no rights or licenses to the intellectual property of any Contributor under this Agreement, whether expressly, by implication, estoppel or otherwise. All rights in the Program not expressly granted under this Agreement are reserved.

This Agreement is governed by the laws of the State of New York and the intellectual property laws of the United States of America. No party to this Agreement will bring a legal action under this Agreement more than one year after the cause of action arose. Each party waives its rights to a jury trial in any resulting litigation.

## □ HttpClient 4.2.1

Copyright 1999-2012 The Apache Software Foundation

This product includes software developed by The Apache Software Foundation (<http://www.apache.org/>).

Apache License  
Version 2.0, January 2004  
<http://www.apache.org/licenses/>

TERMS AND CONDITIONS FOR USE, REPRODUCTION, AND DISTRIBUTION

1. Definitions.

"License" shall mean the terms and conditions for use, reproduction, and distribution as defined by Sections 1 through 9 of this document.

"Licensor" shall mean the copyright owner or entity authorized by the copyright owner that is granting the License.

"Legal Entity" shall mean the union of the acting entity and all other entities that control, are controlled by, or are under common control with that entity. For the purposes of this definition, "control" means (i) the power, direct or indirect, to cause the direction or management of such entity, whether by contract or otherwise, or (ii) ownership of fifty percent (50%) or more of the outstanding shares, or (iii) beneficial ownership of such entity.

"You" (or "Your") shall mean an individual or Legal Entity exercising permissions granted by this License.

"Source" form shall mean the preferred form for making modifications, including but not limited to software source code, documentation source, and configuration files.

"Object" form shall mean any form resulting from mechanical transformation or translation of a Source form, including but not limited to compiled object code, generated documentation, and conversions to other media types.

"Work" shall mean the work of authorship, whether in Source or Object form, made available under the License, as indicated by a copyright notice that is included in or attached to the work (an example is provided in the Appendix below).

"Derivative Works" shall mean any work, whether in Source or Object form, that is based on (or derived from) the Work and for which the editorial revisions, annotations, elaborations, or other modifications represent, as a whole, an original work of authorship. For the purposes of this License, Derivative Works shall not include works that remain separable from, or merely link (or bind by name) to the interfaces of, the Work and Derivative Works thereof.

"Contribution" shall mean any work of authorship, including the original version of the Work and any modifications or additions to that Work or Derivative Works thereof, that is intentionally submitted to Licensor for inclusion in the Work by the copyright owner or by an individual or Legal Entity authorized to submit on behalf of the copyright owner. For the purposes of this definition, "submitted" means any form of electronic, verbal, or written communication sent to the Licensor or its representatives, including but not limited to communication on electronic mailing lists, source code control systems, and issue tracking systems that are managed by, or on behalf of, the Licensor for the purpose of discussing and improving the Work, but excluding communication that is conspicuously marked or otherwise designated in writing by the copyright owner as "Not a Contribution."

"Contributor" shall mean Licensor and any individual or Legal Entity on behalf of whom a Contribution has been received by Licensor and subsequently incorporated within the Work.

2. Grant of Copyright License. Subject to the terms and conditions of this License, each Contributor hereby grants to You a perpetual, worldwide, non-exclusive, no-charge, royalty-free, irrevocable copyright license to reproduce, prepare Derivative Works of, publicly display, publicly perform, sublicense, and distribute the Work and such Derivative Works in Source or Object form.

3. Grant of Patent License. Subject to the terms and conditions of this License, each Contributor hereby grants to You a perpetual, worldwide, non-exclusive, no-charge, royalty-free, irrevocable (except as stated in this section) patent license to make, have made, use, offer to sell, sell, import, and otherwise transfer the Work, where such license applies only to those patent claims licensable by such Contributor that are necessarily infringed by their Contribution(s) alone or by combination of their Contribution(s) with the Work to which such Contribution(s) was submitted. If You institute patent litigation against any entity (including a cross-claim or counterclaim in a lawsuit) alleging that the Work or a Contribution incorporated within the Work constitutes direct or contributory patent infringement, then any patent licenses granted to You under this License for that Work shall terminate as of the date such litigation is filed.

4. Redistribution. You may reproduce and distribute copies of the Work or Derivative Works thereof in any medium, with or without modifications, and in Source or Object form, provided that You meet the following conditions:

(a) You must give any other recipients of the Work or Derivative Works a copy of this License; and

(b) You must cause any modified files to carry prominent notices stating that You changed the files; and

(c) You must retain, in the Source form of any Derivative Works that You distribute, all copyright, patent, trademark, and attribution notices from the Source form of the Work, excluding those notices that do not pertain to any part of the Derivative Works; and

(d) If the Work includes a "NOTICE" text file as part of its distribution, then any Derivative Works that You distribute must include a readable copy of the attribution notices contained within such NOTICE file, excluding those notices that do not pertain to any part of the Derivative Works, in at least one of the following places: within a NOTICE text file distributed as part of the Derivative Works; within the Source form or documentation, if provided along with the Derivative Works; or, within a display generated by the Derivative Works, if and wherever such third-party notices normally appear. The contents of the NOTICE file are for informational purposes only and do not modify the License. You may add Your own attribution notices within Derivative Works that You distribute, alongside or as an addendum to the NOTICE text from the Work, provided that such additional attribution notices cannot be construed as modifying the License.

You may add Your own copyright statement to Your modifications and may provide additional or different license terms and conditions for use, reproduction, or distribution of Your modifications, or for any such Derivative Works as a whole, provided Your use, reproduction, and distribution of the Work otherwise complies with the conditions stated in this License.

5. Submission of Contributions. Unless You explicitly state otherwise, any Contribution intentionally submitted for inclusion in the Work by You to the Licensor shall be under the terms and conditions of this License, without any additional terms or conditions. Notwithstanding the above, nothing herein shall supersede or modify the terms of any separate license agreement you may have executed with Licensor regarding such Contributions.

6. Trademarks. This License does not grant permission to use the trade names, trademarks, service marks, or product names of the Licensor, except as required for reasonable and customary use in describing the origin of the Work and

reproducing the content of the NOTICE file.

7. Disclaimer of Warranty. Unless required by applicable law or agreed to in writing, Licensor provides the Work (and each Contributor provides its Contributions) on an "AS IS" BASIS, WITHOUT WARRANTIES OR CONDITIONS OF ANY KIND, either express or implied, including, without limitation, any warranties or conditions of TITLE, NON-INFRINGEMENT, MERCHANTABILITY, or FITNESS FOR A PARTICULAR PURPOSE. You are solely responsible for determining the appropriateness of using or redistributing the Work and assume any risks associated with Your exercise of permissions under this License.

8. Limitation of Liability. In no event and under no legal theory, whether in tort (including negligence), contract, or otherwise, unless required by applicable law (such as deliberate and grossly negligent acts) or agreed to in writing, shall any Contributor be liable to You for damages, including any direct, indirect, special, incidental, or consequential damages of any character arising as a result of this License or out of the use or inability to use the Work (including but not limited to damages for loss of goodwill, work stoppage, computer failure or malfunction, or any and all other commercial damages or losses), even if such Contributor has been advised of the possibility of such damages.

9. Accepting Warranty or Additional Liability. While redistributing the Work or Derivative Works thereof, You may choose to offer, and charge a fee for, acceptance of support, warranty, indemnity, or other liability obligations and/or rights consistent with this License. However, in accepting such obligations, You may act only on Your own behalf and on Your sole responsibility, not on behalf of any other Contributor, and only if You agree to indemnify, defend, and hold each Contributor harmless for any liability incurred by, or claims asserted against, such Contributor by reason of your accepting any such warranty or additional liability.

#### END OF TERMS AND CONDITIONS

This project contains annotations derived from JCIP-ANNOTATIONS  
Copyright (c) 2005 Brian Goetz and Tim Peierls.  
See <http://www.jcip.net> and the Creative Commons Attribution License  
(<http://creativecommons.org/licenses/by/2.5>)

## □ PDFBox 1.8.2

Apache PDFBox  
Copyright 2002-2013 The Apache Software Foundation

This product includes software developed at The Apache Software Foundation  
(<http://www.apache.org/>).

Based on source code contributed to the original PDFBox project.  
Copyright (c) 2002-2007, [www.pdfbox.org](http://www.pdfbox.org)  
Apache License  
Version 2.0, January 2004  
<http://www.apache.org/licenses/>

#### TERMS AND CONDITIONS FOR USE, REPRODUCTION, AND DISTRIBUTION

##### 1. Definitions.

"License" shall mean the terms and conditions for use, reproduction, and distribution as defined by Sections 1 through 9 of this document.

"Licensor" shall mean the copyright owner or entity authorized by the copyright owner that is granting the License.

"Legal Entity" shall mean the union of the acting entity and all other entities that control, are controlled by, or are under common control with that entity. For the purposes of this definition, "control" means (i) the power, direct or indirect, to cause the direction or management of such entity, whether by contract or otherwise, or (ii) ownership of fifty percent (50%) or more of the outstanding shares, or (iii) beneficial ownership of such entity.

"You" (or "Your") shall mean an individual or Legal Entity exercising permissions granted by this License.

"Source" form shall mean the preferred form for making modifications, including but not limited to software source code, documentation source, and configuration files.

"Object" form shall mean any form resulting from mechanical transformation or translation of a Source form, including but not limited to compiled object code, generated documentation, and conversions to other media types.

"Work" shall mean the work of authorship, whether in Source or Object form, made available under the License, as indicated by a copyright notice that is included in or attached to the work (an example is provided in the Appendix below).

"Derivative Works" shall mean any work, whether in Source or Object form, that is based on (or derived from) the Work and for which the editorial revisions, annotations, elaborations, or other modifications represent, as a whole, an original work of authorship. For the purposes of this License, Derivative Works shall not include works that remain separable from, or merely link (or bind by name) to the interfaces of, the Work and Derivative Works thereof.

"Contribution" shall mean any work of authorship, including the original version of the Work and any modifications or additions to that Work or Derivative Works thereof, that is intentionally submitted to Licensor for inclusion in the Work by the copyright owner or by an individual or Legal Entity authorized to submit on behalf of the copyright owner. For the purposes of this definition, "submitted" means any form of electronic, verbal, or written communication sent to the Licensor or its representatives, including but not limited to communication on electronic mailing lists, source code control systems, and issue tracking systems that are managed by, or on behalf of, the Licensor for the purpose of discussing and improving the Work, but excluding communication that is conspicuously marked or otherwise designated in writing by the copyright owner as "Not a Contribution."

"Contributor" shall mean Licensor and any individual or Legal Entity on behalf of whom a Contribution has been received by Licensor and subsequently incorporated within the Work.

2. Grant of Copyright License. Subject to the terms and conditions of this License, each Contributor hereby grants to You a perpetual, worldwide, non-exclusive, no-charge, royalty-free, irrevocable copyright license to reproduce, prepare Derivative Works of, publicly display, publicly perform, sublicense, and distribute the Work and such Derivative Works in Source or Object form.

3. Grant of Patent License. Subject to the terms and conditions of this License, each Contributor hereby grants to You a perpetual, worldwide, non-exclusive, no-charge, royalty-free, irrevocable (except as stated in this section) patent license

to make, have made, use, offer to sell, sell, import, and otherwise transfer the Work, where such license applies only to those patent claims licensable by such Contributor that are necessarily infringed by their Contribution(s) alone or by combination of their Contribution(s) with the Work to which such Contribution(s) was submitted. If You institute patent litigation against any entity (including a cross-claim or counterclaim in a lawsuit) alleging that the Work or a Contribution incorporated within the Work constitutes direct or contributory patent infringement, then any patent licenses granted to You under this License for that Work shall terminate as of the date such litigation is filed.

4. Redistribution. You may reproduce and distribute copies of the Work or Derivative Works thereof in any medium, with or without modifications, and in Source or Object form, provided that You meet the following conditions:

(a) You must give any other recipients of the Work or Derivative Works a copy of this License; and

(b) You must cause any modified files to carry prominent notices stating that You changed the files; and

(c) You must retain, in the Source form of any Derivative Works that You distribute, all copyright, patent, trademark, and attribution notices from the Source form of the Work, excluding those notices that do not pertain to any part of the Derivative Works; and

(d) If the Work includes a "NOTICE" text file as part of its distribution, then any Derivative Works that You distribute must include a readable copy of the attribution notices contained within such NOTICE file, excluding those notices that do not pertain to any part of the Derivative Works, in at least one of the following places: within a NOTICE text file distributed as part of the Derivative Works; within the Source form or documentation, if provided along with the Derivative Works; or, within a display generated by the Derivative Works, if and wherever such third-party notices normally appear. The contents of the NOTICE file are for informational purposes only and do not modify the License. You may add Your own attribution notices within Derivative Works that You distribute, alongside or as an addendum to the NOTICE text from the Work, provided that such additional attribution notices cannot be construed as modifying the License.

You may add Your own copyright statement to Your modifications and may provide additional or different license terms and conditions for use, reproduction, or distribution of Your modifications, or for any such Derivative Works as a whole, provided Your use, reproduction, and distribution of the Work otherwise complies with the conditions stated in this License.

5. Submission of Contributions. Unless You explicitly state otherwise, any Contribution intentionally submitted for inclusion in the Work by You to the Licensor shall be under the terms and conditions of this License, without any additional terms or conditions. Notwithstanding the above, nothing herein shall supersede or modify the terms of any separate license agreement you may have executed with Licensor regarding such Contributions.

6. Trademarks. This License does not grant permission to use the trade names, trademarks, service marks, or product names of the Licensor, except as required for reasonable and customary use in describing the origin of the Work and reproducing the content of the NOTICE file.

7. Disclaimer of Warranty. Unless required by applicable law or agreed to in writing, Licensor provides the Work (and each Contributor provides its



Contributions) on an "AS IS" BASIS, WITHOUT WARRANTIES OR CONDITIONS OF ANY KIND, either express or implied, including, without limitation, any warranties or conditions of TITLE, NON-INFRINGEMENT, MERCHANTABILITY, or FITNESS FOR A PARTICULAR PURPOSE. You are solely responsible for determining the appropriateness of using or redistributing the Work and assume any risks associated with Your exercise of permissions under this License.

8. Limitation of Liability. In no event and under no legal theory, whether in tort (including negligence), contract, or otherwise, unless required by applicable law (such as deliberate and grossly negligent acts) or agreed to in writing, shall any Contributor be liable to You for damages, including any direct, indirect, special, incidental, or consequential damages of any character arising as a result of this License or out of the use or inability to use the Work (including but not limited to damages for loss of goodwill, work stoppage, computer failure or malfunction, or any and all other commercial damages or losses), even if such Contributor has been advised of the possibility of such damages.

9. Accepting Warranty or Additional Liability. While redistributing the Work or Derivative Works thereof, You may choose to offer, and charge a fee for, acceptance of support, warranty, indemnity, or other liability obligations and/or rights consistent with this License. However, in accepting such obligations, You may act only on Your own behalf and on Your sole responsibility, not on behalf of any other Contributor, and only if You agree to indemnify, defend, and hold each Contributor harmless for any liability incurred by, or claims asserted against, such Contributor by reason of your accepting any such warranty or additional liability.

END OF TERMS AND CONDITIONS

APPENDIX: How to apply the Apache License to your work.

To apply the Apache License to your work, attach the following boilerplate notice, with the fields enclosed by brackets "[]" replaced with your own identifying information. (Don't include the brackets!) The text should be enclosed in the appropriate comment syntax for the file format. We also recommend that a file or class name and description of purpose be included on the same "printed page" as the copyright notice for easier identification within third-party archives.

Copyright [yyyy] [name of copyright owner]

Licensed under the Apache License, Version 2.0 (the "License"); you may not use this file except in compliance with the License. You may obtain a copy of the License at

<http://www.apache.org/licenses/LICENSE-2.0>

Unless required by applicable law or agreed to in writing, software distributed under the License is distributed on an "AS IS" BASIS, WITHOUT WARRANTIES OR CONDITIONS OF ANY KIND, either express or implied. See the License for the specific language governing permissions and limitations under the License.

EXTERNAL COMPONENTS

Apache PDFBox includes a number of components with separate copyright notices and license terms. Your use of these components is subject to the terms and conditions of the following licenses.

Contributions made to the original PDFBox project:

Copyright (c) 2002-2007, www.pdfbox.org  
All rights reserved.

Redistribution and use in source and binary forms, with or without modification, are permitted provided that the following conditions are met:

1. Redistributions of source code must retain the above copyright notice, this list of conditions and the following disclaimer.

2. Redistributions in binary form must reproduce the above copyright notice, this list of conditions and the following disclaimer in the documentation and/or other materials provided with the distribution.

3. Neither the name of pdfbox; nor the names of its contributors may be used to endorse or promote products derived from this software without specific prior written permission.

THIS SOFTWARE IS PROVIDED BY THE COPYRIGHT HOLDERS AND CONTRIBUTORS "AS IS" AND ANY EXPRESS OR IMPLIED WARRANTIES, INCLUDING, BUT NOT LIMITED TO, THE IMPLIED WARRANTIES OF MERCHANTABILITY AND FITNESS FOR A PARTICULAR PURPOSE ARE DISCLAIMED. IN NO EVENT SHALL THE REGENTS OR CONTRIBUTORS BE LIABLE FOR ANY DIRECT, INDIRECT, INCIDENTAL, SPECIAL, EXEMPLARY, OR CONSEQUENTIAL DAMAGES (INCLUDING, BUT NOT LIMITED TO, PROCUREMENT OF SUBSTITUTE GOODS OR SERVICES; LOSS OF USE, DATA, OR PROFITS; OR BUSINESS INTERRUPTION) HOWEVER CAUSED AND ON ANY THEORY OF LIABILITY, WHETHER IN CONTRACT, STRICT LIABILITY, OR TORT (INCLUDING NEGLIGENCE OR OTHERWISE) ARISING IN ANY WAY OUT OF THE USE OF THIS SOFTWARE, EVEN IF ADVISED OF THE POSSIBILITY OF SUCH DAMAGE.

Adobe Font Metrics (AFM) for PDF Core 14 Fonts

This file and the 14 PostScript(R) AFM files it accompanies may be used, copied, and distributed for any purpose and without charge, with or without modification, provided that all copyright notices are retained; that the AFM files are not distributed without this file; that all modifications to this file or any of the AFM files are prominently noted in the modified file(s); and that this paragraph is not modified. Adobe Systems has no responsibility or obligation to support the use of the AFM files.

CMaps for PDF Fonts (<http://opensource.adobe.com/wiki/display/cmap/Downloads>)

Copyright 1990-2009 Adobe Systems Incorporated.  
All rights reserved.

Redistribution and use in source and binary forms, with or without modification, are permitted provided that the following conditions are met:

Redistributions of source code must retain the above copyright notice, this list of conditions and the following disclaimer.

Redistributions in binary form must reproduce the above copyright notice, this list of conditions and the following disclaimer in the documentation and/or other materials provided with the distribution.

Neither the name of Adobe Systems Incorporated nor the names of its contributors may be used to endorse or promote products derived from this



software without specific prior written permission.

THIS SOFTWARE IS PROVIDED BY THE COPYRIGHT HOLDERS AND CONTRIBUTORS "AS IS" AND ANY EXPRESS OR IMPLIED WARRANTIES, INCLUDING, BUT NOT LIMITED TO, THE IMPLIED WARRANTIES OF MERCHANTABILITY AND FITNESS FOR A PARTICULAR PURPOSE ARE DISCLAIMED. IN NO EVENT SHALL THE COPYRIGHT HOLDER OR CONTRIBUTORS BE LIABLE FOR ANY DIRECT, INDIRECT, INCIDENTAL, SPECIAL, EXEMPLARY, OR CONSEQUENTIAL DAMAGES (INCLUDING, BUT NOT LIMITED TO, PROCUREMENT OF SUBSTITUTE GOODS OR SERVICES; LOSS OF USE, DATA, OR PROFITS; OR BUSINESS INTERRUPTION) HOWEVER CAUSED AND ON ANY THEORY OF LIABILITY, WHETHER IN CONTRACT, STRICT LIABILITY, OR TORT (INCLUDING NEGLIGENCE OR OTHERWISE) ARISING IN ANY WAY OUT OF THE USE OF THIS SOFTWARE, EVEN IF ADVISED OF THE POSSIBILITY OF SUCH DAMAGE.

Glyphlist (<http://www.adobe.com/devnet/opentype/archives/glyph.html>)

Copyright (c) 1997,1998,2002,2007 Adobe Systems Incorporated

Permission is hereby granted, free of charge, to any person obtaining a copy of this documentation file to use, copy, publish, distribute, sublicense, and/or sell copies of the documentation, and to permit others to do the same, provided that:

- No modification, editing or other alteration of this document is allowed; and
- The above copyright notice and this permission notice shall be included in all copies of the documentation.

Permission is hereby granted, free of charge, to any person obtaining a copy of this documentation file, to create their own derivative works from the content of this document to use, copy, publish, distribute, sublicense, and/or sell the derivative works, and to permit others to do the same, provided that the derived work is not represented as being a copy or version of this document.

Adobe shall not be liable to any party for any loss of revenue or profit or for indirect, incidental, special, consequential, or other similar damages, whether based on tort (including without limitation negligence or strict liability), contract or other legal or equitable grounds even if Adobe has been advised or had reason to know of the possibility of such damages. The Adobe materials are provided on an "AS IS" basis. Adobe specifically disclaims all express, statutory, or implied warranties relating to the Adobe materials, including but not limited to those concerning merchantability or fitness for a particular purpose or non-infringement of any third party rights regarding the Adobe materials.

## □ jsonic 1.3.0

Apache License

Version 2.0, January 2004

<http://www.apache.org/licenses/>

TERMS AND CONDITIONS FOR USE, REPRODUCTION, AND DISTRIBUTION

1. Definitions.

"License" shall mean the terms and conditions for use, reproduction, and distribution as defined by Sections 1 through 9 of this document.

"Licensor" shall mean the copyright owner or entity authorized by the copyright owner that is granting the License.

"Legal Entity" shall mean the union of the acting entity and all other entities that control, are controlled by, or are under common control with that entity. For the purposes of this definition, "control" means (i) the power, direct or indirect, to cause the direction or management of such entity, whether by contract or otherwise, or (ii) ownership of fifty percent (50%) or more of the outstanding shares, or (iii) beneficial ownership of such entity.

"You" (or "Your") shall mean an individual or Legal Entity exercising permissions granted by this License.

"Source" form shall mean the preferred form for making modifications, including but not limited to software source code, documentation source, and configuration files.

"Object" form shall mean any form resulting from mechanical transformation or translation of a Source form, including but not limited to compiled object code, generated documentation, and conversions to other media types.

"Work" shall mean the work of authorship, whether in Source or Object form, made available under the License, as indicated by a copyright notice that is included in or attached to the work (an example is provided in the Appendix below).

"Derivative Works" shall mean any work, whether in Source or Object form, that is based on (or derived from) the Work and for which the editorial revisions, annotations, elaborations, or other modifications represent, as a whole, an original work of authorship. For the purposes of this License, Derivative Works shall not include works that remain separable from, or merely link (or bind by name) to the interfaces of, the Work and Derivative Works thereof.

"Contribution" shall mean any work of authorship, including the original version of the Work and any modifications or additions to that Work or Derivative Works thereof, that is intentionally submitted to Licensor for inclusion in the Work by the copyright owner or by an individual or Legal Entity authorized to submit on behalf of the copyright owner. For the purposes of this definition, "submitted" means any form of electronic, verbal, or written communication sent to the Licensor or its representatives, including but not limited to communication on electronic mailing lists, source code control systems, and issue tracking systems that are managed by, or on behalf of, the Licensor for the purpose of discussing and improving the Work, but excluding communication that is conspicuously marked or otherwise designated in writing by the copyright owner as "Not a Contribution."

"Contributor" shall mean Licensor and any individual or Legal Entity on behalf of whom a Contribution has been received by Licensor and subsequently incorporated within the Work.

2. Grant of Copyright License. Subject to the terms and conditions of this License, each Contributor hereby grants to You a perpetual, worldwide, non-exclusive, no-charge, royalty-free, irrevocable copyright license to reproduce, prepare Derivative Works of, publicly display, publicly perform, sublicense, and distribute the Work and such Derivative Works in Source or Object form.

3. Grant of Patent License. Subject to the terms and conditions of this License, each Contributor hereby grants to You a perpetual, worldwide, non-exclusive, no-charge, royalty-free, irrevocable (except as stated in this section) patent license

to make, have made, use, offer to sell, sell, import, and otherwise transfer the Work, where such license applies only to those patent claims licensable by such Contributor that are necessarily infringed by their Contribution(s) alone or by combination of their Contribution(s) with the Work to which such Contribution(s) was submitted. If You institute patent litigation against any entity (including a cross-claim or counterclaim in a lawsuit) alleging that the Work or a Contribution incorporated within the Work constitutes direct or contributory patent infringement, then any patent licenses granted to You under this License for that Work shall terminate as of the date such litigation is filed.

4. Redistribution. You may reproduce and distribute copies of the Work or Derivative Works thereof in any medium, with or without modifications, and in Source or Object form, provided that You meet the following conditions:

a. You must give any other recipients of the Work or Derivative Works a copy of this License; and

b. You must cause any modified files to carry prominent notices stating that You changed the files; and

c. You must retain, in the Source form of any Derivative Works that You distribute, all copyright, patent, trademark, and attribution notices from the Source form of the Work, excluding those notices that do not pertain to any part of the Derivative Works; and

d. If the Work includes a "NOTICE" text file as part of its distribution, then any Derivative Works that You distribute must include a readable copy of the attribution notices contained within such NOTICE file, excluding those notices that do not pertain to any part of the Derivative Works, in at least one of the following places: within a NOTICE text file distributed as part of the Derivative Works; within the Source form or documentation, if provided along with the Derivative Works; or, within a display generated by the Derivative Works, if and wherever such third-party notices normally appear. The contents of the NOTICE file are for informational purposes only and do not modify the License. You may add Your own attribution notices within Derivative Works that You distribute, alongside or as an addendum to the NOTICE text from the Work, provided that such additional attribution notices cannot be construed as modifying the License.

You may add Your own copyright statement to Your modifications and may provide additional or different license terms and conditions for use, reproduction, or distribution of Your modifications, or for any such Derivative Works as a whole, provided Your use, reproduction, and distribution of the Work otherwise complies with the conditions stated in this License.

5. Submission of Contributions. Unless You explicitly state otherwise, any Contribution intentionally submitted for inclusion in the Work by You to the Licensor shall be under the terms and conditions of this License, without any additional terms or conditions. Notwithstanding the above, nothing herein shall supersede or modify the terms of any separate license agreement you may have executed with Licensor regarding such Contributions.

6. Trademarks. This License does not grant permission to use the trade names, trademarks, service marks, or product names of the Licensor, except as required for reasonable and customary use in describing the origin of the Work and reproducing the content of the NOTICE file.

7. Disclaimer of Warranty. Unless required by applicable law or agreed to in writing, Licensor provides the Work (and each Contributor provides its Contributions) on an "AS IS" BASIS, WITHOUT WARRANTIES OR CONDITIONS OF ANY KIND, either express or implied, including, without limitation, any warranties or conditions of TITLE, NON-INFRINGEMENT, MERCHANTABILITY, or FITNESS FOR A PARTICULAR PURPOSE. You are solely responsible for determining

the appropriateness of using or redistributing the Work and assume any risks associated with Your exercise of permissions under this License.

8. Limitation of Liability. In no event and under no legal theory, whether in tort (including negligence), contract, or otherwise, unless required by applicable law (such as deliberate and grossly negligent acts) or agreed to in writing, shall any Contributor be liable to You for damages, including any direct, indirect, special, incidental, or consequential damages of any character arising as a result of this License or out of the use or inability to use the Work (including but not limited to damages for loss of goodwill, work stoppage, computer failure or malfunction, or any and all other commercial damages or losses), even if such Contributor has been advised of the possibility of such damages.

9. Accepting Warranty or Additional Liability. While redistributing the Work or Derivative Works thereof, You may choose to offer, and charge a fee for, acceptance of support, warranty, indemnity, or other liability obligations and/or rights consistent with this License. However, in accepting such obligations, You may act only on Your own behalf and on Your sole responsibility, not on behalf of any other Contributor, and only if You agree to indemnify, defend, and hold each Contributor harmless for any liability incurred by, or claims asserted against, such Contributor by reason of your accepting any such warranty or additional liability.

END OF TERMS AND CONDITIONS

APPENDIX: How to apply the Apache License to your work

To apply the Apache License to your work, attach the following boilerplate notice, with the fields enclosed by brackets "[ ]" replaced with your own identifying information. (Don't include the brackets!) The text should be enclosed in the appropriate comment syntax for the file format. We also recommend that a file or class name and description of purpose be included on the same "printed page" as the copyright notice for easier identification within third-party archives.

Copyright [yyyy] [name of copyright owner]

Licensed under the Apache License, Version 2.0 (the "License"); you may not use this file except in compliance with the License.  
You may obtain a copy of the License at

<http://www.apache.org/licenses/LICENSE-2.0>

Unless required by applicable law or agreed to in writing, software distributed under the License is distributed on an "AS IS" BASIS, WITHOUT WARRANTIES OR CONDITIONS OF ANY KIND, either express or implied. See the License for the specific language governing permissions and limitations under the License.

## □ jstl

Apache License

Version 2.0, January 2004

<http://www.apache.org/licenses/>

TERMS AND CONDITIONS FOR USE, REPRODUCTION, AND DISTRIBUTION

1. Definitions.

"License" shall mean the terms and conditions for use, reproduction, and distribution as defined by Sections 1 through 9 of this document.

"Licensor" shall mean the copyright owner or entity authorized by the copyright owner that is granting the License.

"Legal Entity" shall mean the union of the acting entity and all other entities that control, are controlled by, or are under common control with that entity. For the purposes of this definition, "control" means (i) the power, direct or indirect, to cause the direction or management of such entity, whether by contract or otherwise, or (ii) ownership of fifty percent (50%) or more of the outstanding shares, or (iii) beneficial ownership of such entity.

"You" (or "Your") shall mean an individual or Legal Entity exercising permissions granted by this License.

"Source" form shall mean the preferred form for making modifications, including but not limited to software source code, documentation source, and configuration files.

"Object" form shall mean any form resulting from mechanical transformation or translation of a Source form, including but not limited to compiled object code, generated documentation, and conversions to other media types.

"Work" shall mean the work of authorship, whether in Source or Object form, made available under the License, as indicated by a copyright notice that is included in or attached to the work (an example is provided in the Appendix below).

"Derivative Works" shall mean any work, whether in Source or Object form, that is based on (or derived from) the Work and for which the editorial revisions, annotations, elaborations, or other modifications represent, as a whole, an original work of authorship. For the purposes of this License, Derivative Works shall not include works that remain separable from, or merely link (or bind by name) to the interfaces of, the Work and Derivative Works thereof.

"Contribution" shall mean any work of authorship, including the original version of the Work and any modifications or additions to that Work or Derivative Works thereof, that is intentionally submitted to Licensor for inclusion in the Work by the copyright owner or by an individual or Legal Entity authorized to submit on behalf of the copyright owner. For the purposes of this definition, "submitted" means any form of electronic, verbal, or written communication sent to the Licensor or its representatives, including but not limited to communication on electronic mailing lists, source code control systems, and issue tracking systems that are managed by, or on behalf of, the Licensor for the purpose of discussing and improving the Work, but excluding communication that is conspicuously marked or otherwise designated in writing by the copyright owner as "Not a Contribution."

"Contributor" shall mean Licensor and any individual or Legal Entity on behalf of whom a Contribution has been received by Licensor and subsequently incorporated within the Work.

2. Grant of Copyright License. Subject to the terms and conditions of this License, each Contributor hereby grants to You a perpetual, worldwide, non-exclusive, no-charge, royalty-free, irrevocable copyright license to reproduce, prepare Derivative Works of, publicly display, publicly perform, sublicense, and distribute the Work and such Derivative Works in Source or Object form.

3. Grant of Patent License. Subject to the terms and conditions of this License, each Contributor hereby grants to You a perpetual, worldwide, non-exclusive, no-charge, royalty-free, irrevocable (except as stated in this section) patent license to make, have made, use, offer to sell, sell, import, and otherwise transfer the Work, where such license applies only to those patent claims licensable by such Contributor that are necessarily infringed by their Contribution(s) alone or by combination of their Contribution(s) with the Work to which such Contribution(s) was submitted. If You institute patent litigation against any entity (including a cross-claim or counterclaim in a lawsuit) alleging that the Work or a Contribution incorporated within the Work constitutes direct or contributory patent infringement, then any patent licenses granted to You under this License for that Work shall terminate as of the date such litigation is filed.

4. Redistribution. You may reproduce and distribute copies of the Work or Derivative Works thereof in any medium, with or without modifications, and in Source or Object form, provided that You meet the following conditions:

a. You must give any other recipients of the Work or Derivative Works a copy of this License; and

b. You must cause any modified files to carry prominent notices stating that You changed the files; and

c. You must retain, in the Source form of any Derivative Works that You distribute, all copyright, patent, trademark, and attribution notices from the Source form of the Work, excluding those notices that do not pertain to any part of the Derivative Works; and

d. If the Work includes a "NOTICE" text file as part of its distribution, then any Derivative Works that You distribute must include a readable copy of the attribution notices contained within such NOTICE file, excluding those notices that do not pertain to any part of the Derivative Works, in at least one of the following places: within a NOTICE text file distributed as part of the Derivative Works; within the Source form or documentation, if provided along with the Derivative Works; or, within a display generated by the Derivative Works, if and wherever such third-party notices normally appear. The contents of the NOTICE file are for informational purposes only and do not modify the License. You may add Your own attribution notices within Derivative Works that You distribute, alongside or as an addendum to the NOTICE text from the Work, provided that such additional attribution notices cannot be construed as modifying the License.

You may add Your own copyright statement to Your modifications and may provide additional or different license terms and conditions for use, reproduction, or distribution of Your modifications, or for any such Derivative Works as a whole, provided Your use, reproduction, and distribution of the Work otherwise complies with the conditions stated in this License.

5. Submission of Contributions. Unless You explicitly state otherwise, any Contribution intentionally submitted for inclusion in the Work by You to the Licensor shall be under the terms and conditions of this License, without any additional terms or conditions. Notwithstanding the above, nothing herein shall supersede or modify the terms of any separate license agreement you may have executed with Licensor regarding such Contributions.

6. Trademarks. This License does not grant permission to use the trade names, trademarks, service marks, or product names of the Licensor, except as required for reasonable and customary use in describing the origin of the Work and reproducing the content of the NOTICE file.

7. Disclaimer of Warranty. Unless required by applicable law or agreed to in writing, Licensor provides the Work (and each Contributor provides its Contributions) on an "AS IS" BASIS, WITHOUT WARRANTIES OR CONDITIONS OF



ANY KIND, either express or implied, including, without limitation, any warranties or conditions of TITLE, NON-INFRINGEMENT, MERCHANTABILITY, or FITNESS FOR A PARTICULAR PURPOSE. You are solely responsible for determining the appropriateness of using or redistributing the Work and assume any risks associated with Your exercise of permissions under this License.

8. Limitation of Liability. In no event and under no legal theory, whether in tort (including negligence), contract, or otherwise, unless required by applicable law (such as deliberate and grossly negligent acts) or agreed to in writing, shall any Contributor be liable to You for damages, including any direct, indirect, special, incidental, or consequential damages of any character arising as a result of this License or out of the use or inability to use the Work (including but not limited to damages for loss of goodwill, work stoppage, computer failure or malfunction, or any and all other commercial damages or losses), even if such Contributor has been advised of the possibility of such damages.

9. Accepting Warranty or Additional Liability. While redistributing the Work or Derivative Works thereof, You may choose to offer, and charge a fee for, acceptance of support, warranty, indemnity, or other liability obligations and/or rights consistent with this License. However, in accepting such obligations, You may act only on Your own behalf and on Your sole responsibility, not on behalf of any other Contributor, and only if You agree to indemnify, defend, and hold each Contributor harmless for any liability incurred by, or claims asserted against, such Contributor by reason of your accepting any such warranty or additional liability.

END OF TERMS AND CONDITIONS

APPENDIX: How to apply the Apache License to your work

To apply the Apache License to your work, attach the following boilerplate notice, with the fields enclosed by brackets "[ ]" replaced with your own identifying information. (Don't include the brackets!) The text should be enclosed in the appropriate comment syntax for the file format. We also recommend that a file or class name and description of purpose be included on the same "printed page" as the copyright notice for easier identification within third-party archives.

```
Copyright [yyyy] [name of copyright owner]
```

```
Licensed under the Apache License, Version 2.0 (the "License"); you may not use  
this file except in compliance with the License.  
You may obtain a copy of the License at
```

```
http://www.apache.org/licenses/LICENSE-2.0
```

```
Unless required by applicable law or agreed to in writing, software distributed  
under the License is distributed on an "AS IS" BASIS, WITHOUT WARRANTIES OR  
CONDITIONS OF ANY KIND, either express or implied. See the License for the  
specific language governing permissions and limitations under the License.
```

## □ jQuery 1.10.2

jQuery v1.10.2 (c) 2005, 2013 jQuery Foundation, Inc.

The MIT License (MIT)

Copyright (c) <year> <copyright holders>

Permission is hereby granted, free of charge, to any person obtaining a copy of this software and associated documentation files (the "Software"), to deal in the Software without restriction, including without limitation the rights to use, copy,

modify, merge, publish, distribute, sublicense, and/or sell copies of the Software, and to permit persons to whom the Software is furnished to do so, subject to the following conditions:

The above copyright notice and this permission notice shall be included in all copies or substantial portions of the Software.

THE SOFTWARE IS PROVIDED "AS IS", WITHOUT WARRANTY OF ANY KIND, EXPRESS OR IMPLIED, INCLUDING BUT NOT LIMITED TO THE WARRANTIES OF MERCHANTABILITY, FITNESS FOR A PARTICULAR PURPOSE AND NONINFRINGEMENT. IN NO EVENT SHALL THE AUTHORS OR COPYRIGHT HOLDERS BE LIABLE FOR ANY CLAIM, DAMAGES OR OTHER LIABILITY, WHETHER IN AN ACTION OF CONTRACT, TORT OR OTHERWISE, ARISING FROM, OUT OF OR IN CONNECTION WITH THE SOFTWARE OR THE USE OR OTHER DEALINGS IN THE SOFTWARE.

## □ BouncyCastele

Please note: our license is an adaptation of the MIT X11 License and should be read as such.

<http://opensource.org/licenses/mit-license.php>

LICENSE

Copyright (c) 2000 - 2012 The Legion Of The Bouncy Castle (<http://www.bouncycastle.org>)

Permission is hereby granted, free of charge, to any person obtaining a copy of this software and associated documentation files (the "Software"), to deal in the Software without restriction, including without limitation the rights to use, copy, modify, merge, publish, distribute, sublicense, and/or sell copies of the Software, and to permit persons to whom the Software is furnished to do so, subject to the following conditions:

The above copyright notice and this permission notice shall be included in all copies or substantial portions of the Software.

THE SOFTWARE IS PROVIDED "AS IS", WITHOUT WARRANTY OF ANY KIND, EXPRESS OR IMPLIED, INCLUDING BUT NOT LIMITED TO THE WARRANTIES OF MERCHANTABILITY, FITNESS FOR A PARTICULAR PURPOSE AND NONINFRINGEMENT. IN NO EVENT SHALL THE AUTHORS OR COPYRIGHT HOLDERS BE LIABLE FOR ANY CLAIM, DAMAGES OR OTHER LIABILITY, WHETHER IN AN ACTION OF CONTRACT, TORT OR OTHERWISE, ARISING FROM, OUT OF OR IN CONNECTION WITH THE SOFTWARE OR THE USE OR OTHER DEALINGS IN THE SOFTWARE.

## □ commons-compress 1.4.1

Apache Commons Compress

Copyright 2002-2012 The Apache Software Foundation

This product includes software developed by The Apache Software Foundation (<http://www.apache.org/>).

Apache License

Version 2.0, January 2004

<http://www.apache.org/licenses/>

TERMS AND CONDITIONS FOR USE, REPRODUCTION, AND DISTRIBUTION



## 1. Definitions.

"License" shall mean the terms and conditions for use, reproduction, and distribution as defined by Sections 1 through 9 of this document.

"Licensor" shall mean the copyright owner or entity authorized by the copyright owner that is granting the License.

"Legal Entity" shall mean the union of the acting entity and all other entities that control, are controlled by, or are under common control with that entity. For the purposes of this definition, "control" means (i) the power, direct or indirect, to cause the direction or management of such entity, whether by contract or otherwise, or (ii) ownership of fifty percent (50%) or more of the outstanding shares, or (iii) beneficial ownership of such entity.

"You" (or "Your") shall mean an individual or Legal Entity exercising permissions granted by this License.

"Source" form shall mean the preferred form for making modifications, including but not limited to software source code, documentation source, and configuration files.

"Object" form shall mean any form resulting from mechanical transformation or translation of a Source form, including but not limited to compiled object code, generated documentation, and conversions to other media types.

"Work" shall mean the work of authorship, whether in Source or Object form, made available under the License, as indicated by a copyright notice that is included in or attached to the work (an example is provided in the Appendix below).

"Derivative Works" shall mean any work, whether in Source or Object form, that is based on (or derived from) the Work and for which the editorial revisions, annotations, elaborations, or other modifications represent, as a whole, an original work of authorship. For the purposes of this License, Derivative Works shall not include works that remain separable from, or merely link (or bind by name) to the interfaces of, the Work and Derivative Works thereof.

"Contribution" shall mean any work of authorship, including the original version of the Work and any modifications or additions to that Work or Derivative Works thereof, that is intentionally submitted to Licensor for inclusion in the Work by the copyright owner or by an individual or Legal Entity authorized to submit on behalf of the copyright owner. For the purposes of this definition, "submitted" means any form of electronic, verbal, or written communication sent to the Licensor or its representatives, including but not limited to communication on electronic mailing lists, source code control systems, and issue tracking systems that are managed by, or on behalf of, the Licensor for the purpose of discussing and improving the Work, but excluding communication that is conspicuously marked or otherwise designated in writing by the copyright owner as "Not a Contribution."

"Contributor" shall mean Licensor and any individual or Legal Entity on behalf of whom a Contribution has been received by Licensor and subsequently incorporated within the Work.

2. Grant of Copyright License. Subject to the terms and conditions of this License, each Contributor hereby grants to You a perpetual, worldwide, non-exclusive, no-charge, royalty-free, irrevocable copyright license to reproduce, prepare Derivative Works of, publicly display, publicly perform, sublicense, and

distribute the Work and such Derivative Works in Source or Object form.

3. Grant of Patent License. Subject to the terms and conditions of this License, each Contributor hereby grants to You a perpetual, worldwide, non-exclusive, no-charge, royalty-free, irrevocable (except as stated in this section) patent license to make, have made, use, offer to sell, sell, import, and otherwise transfer the Work, where such license applies only to those patent claims licensable by such Contributor that are necessarily infringed by their Contribution(s) alone or by combination of their Contribution(s) with the Work to which such Contribution(s) was submitted. If You institute patent litigation against any entity (including a cross-claim or counterclaim in a lawsuit) alleging that the Work or a Contribution incorporated within the Work constitutes direct or contributory patent infringement, then any patent licenses granted to You under this License for that Work shall terminate as of the date such litigation is filed.

4. Redistribution. You may reproduce and distribute copies of the Work or Derivative Works thereof in any medium, with or without modifications, and in Source or Object form, provided that You meet the following conditions:

(a) You must give any other recipients of the Work or Derivative Works a copy of this License; and

(b) You must cause any modified files to carry prominent notices stating that You changed the files; and

(c) You must retain, in the Source form of any Derivative Works that You distribute, all copyright, patent, trademark, and attribution notices from the Source form of the Work, excluding those notices that do not pertain to any part of the Derivative Works; and

(d) If the Work includes a "NOTICE" text file as part of its distribution, then any Derivative Works that You distribute must include a readable copy of the attribution notices contained within such NOTICE file, excluding those notices that do not pertain to any part of the Derivative Works, in at least one of the following places: within a NOTICE text file distributed as part of the Derivative Works; within the Source form or documentation, if provided along with the Derivative Works; or, within a display generated by the Derivative Works, if and wherever such third-party notices normally appear. The contents of the NOTICE file are for informational purposes only and do not modify the License. You may add Your own attribution notices within Derivative Works that You distribute, alongside or as an addendum to the NOTICE text from the Work, provided that such additional attribution notices cannot be construed as modifying the License.

You may add Your own copyright statement to Your modifications and may provide additional or different license terms and conditions for use, reproduction, or distribution of Your modifications, or for any such Derivative Works as a whole, provided Your use, reproduction, and distribution of the Work otherwise complies with the conditions stated in this License.

5. Submission of Contributions. Unless You explicitly state otherwise, any Contribution intentionally submitted for inclusion in the Work by You to the Licensor shall be under the terms and conditions of this License, without any additional terms or conditions. Notwithstanding the above, nothing herein shall supersede or modify the terms of any separate license agreement you may have executed with Licensor regarding such Contributions.

6. Trademarks. This License does not grant permission to use the trade names, trademarks, service marks, or product names of the Licensor, except as required

for reasonable and customary use in describing the origin of the Work and reproducing the content of the NOTICE file.

7. Disclaimer of Warranty. Unless required by applicable law or agreed to in writing, Licensor provides the Work (and each Contributor provides its Contributions) on an "AS IS" BASIS, WITHOUT WARRANTIES OR CONDITIONS OF ANY KIND, either express or implied, including, without limitation, any warranties or conditions of TITLE, NON-INFRINGEMENT, MERCHANTABILITY, or FITNESS FOR A PARTICULAR PURPOSE. You are solely responsible for determining the appropriateness of using or redistributing the Work and assume any risks associated with Your exercise of permissions under this License.

8. Limitation of Liability. In no event and under no legal theory, whether in tort (including negligence), contract, or otherwise, unless required by applicable law (such as deliberate and grossly negligent acts) or agreed to in writing, shall any Contributor be liable to You for damages, including any direct, indirect, special, incidental, or consequential damages of any character arising as a result of this License or out of the use or inability to use the Work (including but not limited to damages for loss of goodwill, work stoppage, computer failure or malfunction, or any and all other commercial damages or losses), even if such Contributor has been advised of the possibility of such damages.

9. Accepting Warranty or Additional Liability. While redistributing the Work or Derivative Works thereof, You may choose to offer, and charge a fee for, acceptance of support, warranty, indemnity, or other liability obligations and/or rights consistent with this License. However, in accepting such obligations, You may act only on Your own behalf and on Your sole responsibility, not on behalf of any other Contributor, and only if You agree to indemnify, defend, and hold each Contributor harmless for any liability incurred by, or claims asserted against, such Contributor by reason of your accepting any such warranty or additional liability.

END OF TERMS AND CONDITIONS

APPENDIX: How to apply the Apache License to your work.

To apply the Apache License to your work, attach the following boilerplate notice, with the fields enclosed by brackets "[]" replaced with your own identifying information. (Don't include the brackets!) The text should be enclosed in the appropriate comment syntax for the file format. We also recommend that a file or class name and description of purpose be included on the same "printed page" as the copyright notice for easier identification within third-party archives.

Copyright [yyyy] [name of copyright owner]

Licensed under the Apache License, Version 2.0 (the "License"); you may not use this file except in compliance with the License.  
You may obtain a copy of the License at

<http://www.apache.org/licenses/LICENSE-2.0>

Unless required by applicable law or agreed to in writing, software distributed under the License is distributed on an "AS IS" BASIS, WITHOUT WARRANTIES OR CONDITIONS OF ANY KIND, either express or implied. See the License for the specific language governing permissions and limitations under the License.

## □ jQuery -UI1.10.2

The MIT License (MIT)

Copyright 2013 jQuery Foundation and other contributors Licensed MIT

Permission is hereby granted, free of charge, to any person obtaining a copy of this software and associated documentation files (the "Software"), to deal in the Software without restriction, including without limitation the rights to use, copy, modify, merge, publish, distribute, sublicense, and/or sell copies of the Software, and to permit persons to whom the Software is furnished to do so, subject to the following conditions:

The above copyright notice and this permission notice shall be included in all copies or substantial portions of the Software.

THE SOFTWARE IS PROVIDED "AS IS", WITHOUT WARRANTY OF ANY KIND, EXPRESS OR IMPLIED, INCLUDING BUT NOT LIMITED TO THE WARRANTIES OF MERCHANTABILITY, FITNESS FOR A PARTICULAR PURPOSE AND NONINFRINGEMENT. IN NO EVENT SHALL THE AUTHORS OR COPYRIGHT HOLDERS BE LIABLE FOR ANY CLAIM, DAMAGES OR OTHER LIABILITY, WHETHER IN AN ACTION OF CONTRACT, TORT OR OTHERWISE, ARISING FROM, OUT OF OR IN CONNECTION WITH THE SOFTWARE OR THE USE OR OTHER DEALINGS IN THE SOFTWARE.

## □ SNMP4J 2.2.2

Apache License

Version 2.0, January 2004

<http://www.apache.org/licenses/>

TERMS AND CONDITIONS FOR USE, REPRODUCTION, AND DISTRIBUTION

1. Definitions.

"License" shall mean the terms and conditions for use, reproduction, and distribution as defined by Sections 1 through 9 of this document.

"Licensor" shall mean the copyright owner or entity authorized by the copyright owner that is granting the License.

"Legal Entity" shall mean the union of the acting entity and all other entities that control, are controlled by, or are under common control with that entity. For the purposes of this definition, "control" means (i) the power, direct or indirect, to cause the direction or management of such entity, whether by contract or otherwise, or (ii) ownership of fifty percent (50%) or more of the outstanding shares, or (iii) beneficial ownership of such entity.

"You" (or "Your") shall mean an individual or Legal Entity exercising permissions granted by this License.

"Source" form shall mean the preferred form for making modifications, including but not limited to software source code, documentation source, and configuration files.

"Object" form shall mean any form resulting from mechanical transformation or translation of a Source form, including but not limited to compiled object code, generated documentation, and conversions to other media types.

"Work" shall mean the work of authorship, whether in Source or Object form, made available under the License, as indicated by a copyright notice that is

included in or attached to the work (an example is provided in the Appendix below).

"Derivative Works" shall mean any work, whether in Source or Object form, that is based on (or derived from) the Work and for which the editorial revisions, annotations, elaborations, or other modifications represent, as a whole, an original work of authorship. For the purposes of this License, Derivative Works shall not include works that remain separable from, or merely link (or bind by name) to the interfaces of, the Work and Derivative Works thereof.

"Contribution" shall mean any work of authorship, including the original version of the Work and any modifications or additions to that Work or Derivative Works thereof, that is intentionally submitted to Licensor for inclusion in the Work by the copyright owner or by an individual or Legal Entity authorized to submit on behalf of the copyright owner. For the purposes of this definition, "submitted" means any form of electronic, verbal, or written communication sent to the Licensor or its representatives, including but not limited to communication on electronic mailing lists, source code control systems, and issue tracking systems that are managed by, or on behalf of, the Licensor for the purpose of discussing and improving the Work, but excluding communication that is conspicuously marked or otherwise designated in writing by the copyright owner as "Not a Contribution."

"Contributor" shall mean Licensor and any individual or Legal Entity on behalf of whom a Contribution has been received by Licensor and subsequently incorporated within the Work.

2. Grant of Copyright License. Subject to the terms and conditions of this License, each Contributor hereby grants to You a perpetual, worldwide, non-exclusive, no-charge, royalty-free, irrevocable copyright license to reproduce, prepare Derivative Works of, publicly display, publicly perform, sublicense, and distribute the Work and such Derivative Works in Source or Object form.

3. Grant of Patent License. Subject to the terms and conditions of this License, each Contributor hereby grants to You a perpetual, worldwide, non-exclusive, no-charge, royalty-free, irrevocable (except as stated in this section) patent license to make, have made, use, offer to sell, sell, import, and otherwise transfer the Work, where such license applies only to those patent claims licensable by such Contributor that are necessarily infringed by their Contribution(s) alone or by combination of their Contribution(s) with the Work to which such Contribution(s) was submitted. If You institute patent litigation against any entity (including a cross-claim or counterclaim in a lawsuit) alleging that the Work or a Contribution incorporated within the Work constitutes direct or contributory patent infringement, then any patent licenses granted to You under this License for that Work shall terminate as of the date such litigation is filed.

4. Redistribution. You may reproduce and distribute copies of the Work or Derivative Works thereof in any medium, with or without modifications, and in Source or Object form, provided that You meet the following conditions:

- a. You must give any other recipients of the Work or Derivative Works a copy of this License; and
- b. You must cause any modified files to carry prominent notices stating that You changed the files; and
- c. You must retain, in the Source form of any Derivative Works that You distribute, all copyright, patent, trademark, and attribution notices from the Source form of the Work, excluding those notices that do not pertain to any part of the Derivative Works; and
- d. If the Work includes a "NOTICE" text file as part of its distribution, then any Derivative Works that You distribute must include a readable copy of the

attribution notices contained within such NOTICE file, excluding those notices that do not pertain to any part of the Derivative Works, in at least one of the following places: within a NOTICE text file distributed as part of the Derivative Works; within the Source form or documentation, if provided along with the Derivative Works; or, within a display generated by the Derivative Works, if and wherever such third-party notices normally appear. The contents of the NOTICE file are for informational purposes only and do not modify the License. You may add Your own attribution notices within Derivative Works that You distribute, alongside or as an addendum to the NOTICE text from the Work, provided that such additional attribution notices cannot be construed as modifying the License.

You may add Your own copyright statement to Your modifications and may provide additional or different license terms and conditions for use, reproduction, or distribution of Your modifications, or for any such Derivative Works as a whole, provided Your use, reproduction, and distribution of the Work otherwise complies with the conditions stated in this License.

5. Submission of Contributions. Unless You explicitly state otherwise, any Contribution intentionally submitted for inclusion in the Work by You to the Licensor shall be under the terms and conditions of this License, without any additional terms or conditions. Notwithstanding the above, nothing herein shall supersede or modify the terms of any separate license agreement you may have executed with Licensor regarding such Contributions.

6. Trademarks. This License does not grant permission to use the trade names, trademarks, service marks, or product names of the Licensor, except as required for reasonable and customary use in describing the origin of the Work and reproducing the content of the NOTICE file.

7. Disclaimer of Warranty. Unless required by applicable law or agreed to in writing, Licensor provides the Work (and each Contributor provides its Contributions) on an "AS IS" BASIS, WITHOUT WARRANTIES OR CONDITIONS OF ANY KIND, either express or implied, including, without limitation, any warranties or conditions of TITLE, NON-INFRINGEMENT, MERCHANTABILITY, or FITNESS FOR A PARTICULAR PURPOSE. You are solely responsible for determining the appropriateness of using or redistributing the Work and assume any risks associated with Your exercise of permissions under this License.

8. Limitation of Liability. In no event and under no legal theory, whether in tort (including negligence), contract, or otherwise, unless required by applicable law (such as deliberate and grossly negligent acts) or agreed to in writing, shall any Contributor be liable to You for damages, including any direct, indirect, special, incidental, or consequential damages of any character arising as a result of this License or out of the use or inability to use the Work (including but not limited to damages for loss of goodwill, work stoppage, computer failure or malfunction, or any and all other commercial damages or losses), even if such Contributor has been advised of the possibility of such damages.

9. Accepting Warranty or Additional Liability. While redistributing the Work or Derivative Works thereof, You may choose to offer, and charge a fee for, acceptance of support, warranty, indemnity, or other liability obligations and/or rights consistent with this License. However, in accepting such obligations, You may act only on Your own behalf and on Your sole responsibility, not on behalf of any other Contributor, and only if You agree to indemnify, defend, and hold each Contributor harmless for any liability incurred by, or claims asserted against, such Contributor by reason of your accepting any such warranty or additional liability.

END OF TERMS AND CONDITIONS



## APPENDIX: How to apply the Apache License to your work

To apply the Apache License to your work, attach the following boilerplate notice, with the fields enclosed by brackets "[ ]" replaced with your own identifying information. (Don't include the brackets!) The text should be enclosed in the appropriate comment syntax for the file format. We also recommend that a file or class name and description of purpose be included on the same "printed page" as the copyright notice for easier identification within third-party archives.

Copyright [yyyy] [name of copyright owner]

Licensed under the Apache License, Version 2.0 (the "License"); you may not use this file except in compliance with the License.  
You may obtain a copy of the License at

<http://www.apache.org/licenses/LICENSE-2.0>

Unless required by applicable law or agreed to in writing, software distributed under the License is distributed on an "AS IS" BASIS, WITHOUT WARRANTIES OR CONDITIONS OF ANY KIND, either express or implied. See the License for the specific language governing permissions and limitations under the License.

### □ Ghostscript 2.2.2

This package was debianized by Masayuki Hatta (mhatta) <mhatta@debian.org> on Tue, 23 Mar 2004 19:46:37 +0900.

It was downloaded from <ftp://mirror.cs.wisc.edu/pub/mirrors/ghost/GPL/>

Note: The directory Resource/CMap is stripped from the source tarball, as its content is not GPL-licensed (only verbatim copying is allowed). Also, jasper/doc/\*.pdf have been removed since their corresponding sources are not available.

Upstream Author: artofcode LLC. <<http://artofcode.com/>>

Copyright:

From LICENSE:

Copyright (c) Artifex Software Inc., All Rights Reserved.

The files in the src, lib, toolbin, examples, ijs, doc and man directories (folders) and any subdirectories (sub-folders) thereof are part of GPL Ghostscript.

The files in the Resource directory and any subdirectories thereof are also part of GPL Ghostscript, with the explicit exception of the files in the CMap subdirectory. The CMap files are copyright Adobe Systems Incorporated and covered by a separate license which permits only verbatim distribution.

(Non-free CMap files have been removed from the Debian package. - ed.)

GPL Ghostscript is free software; you can redistribute it and/or modify it under the terms of version 2 of the GNU General Public License as published by the Free Software Foundation.

GPL Ghostscript is distributed in the hope that it will be useful, but WITHOUT ANY WARRANTY; without even the implied warranty of MERCHANTABILITY or FITNESS

FOR A PARTICULAR PURPOSE. See the GNU General Public License for more details.

You should have received a copy of the GNU General Public License along with this program so you can know your rights and responsibilities. It should be in a file named doc/COPYING. If not, write to the Free Software Foundation, Inc., 51 Franklin Street, Fifth Floor, Boston, MA 02110-1301, USA.

GPL Ghostscript contains an implementation of techniques covered by US Patents 5,055,942 and 5,917,614, and corresponding international patents. These patents are licensed for use with GPL Ghostscript under the following grant:

Whereas, Raph Levien (hereinafter "Inventor") has obtained patent protection for related technology (hereinafter "Patented Technology"), Inventor wishes to aid the the GNU free software project in achieving its goals, and Inventor also wishes to increase public awareness of Patented Technology, Inventor hereby grants a fully paid up, nonexclusive, royalty free license to practice the patents listed below ("the Patents") if and only if practiced in conjunction with software distributed under the terms of any version of the GNU General Public License as published by the Free Software Foundation, 51 Franklin Street, Fifth Floor, Boston, MA 02110-1301, USA. Inventor reserves all other rights, including without limitation, licensing for software not distributed under the GNU General Public License.

5055942 Photographic image reproduction device using digital halftoning to screen images allowing adjustable coarseness

5917614 Method and apparatus for error diffusion screening of images with improved smoothness in highlight and shadow regions

On Debian systems, the complete text of the GNU General Public License Version 2 can be found in ``/usr/share/common-licenses/GPL-2'`.

The GPL Ghostscript distribution contains several third party software, and some of them are governed by different licenses instead of GNU GPL2.

For files in the icclib directory:

\*\*\*\*\*

Copyright (c) 1997-2002 Graeme W. Gill

Permission is hereby granted, to use, copy, modify, distribute, and sell this software and its associated documentation files (the "Software") for any purpose without fee, provided that:

1) The above copyright notices and this permission notice accompany all source code copies of the Software and related documentation. and

2) If executable code based on the Software only is distributed, then the accompanying documentation must acknowledge that "this software is based in part on the work of Graeme W. Gill". and

3) It is accepted that Graeme W. Gill (the "Author") accepts NO LIABILITY for damages of any kind. The Software is provided without fee by the Author "AS-IS" and without warranty of any kind, express, implied or otherwise, including without limitation, any warranty of merchantability or fitness for a particular purpose. and

4) These conditions apply to any software derived from or based on the Software, not just to the unmodified library. and



5) Except as contained in this notice, or in the required acknowledgment, the name of the Author, or the name of any organization or company affiliated with the Author may not be used in any advertising or publicity relating to the Software, without the specific, prior written permission of the Author.

\*\*\*\*\*

For files in the jasper directory:

JasPer License Version 2.0

Copyright (c) 1999-2000 Image Power, Inc.

Copyright (c) 1999-2000 The University of British Columbia

Copyright (c) 2001-2003 Michael David Adams

All rights reserved.

Permission is hereby granted, free of charge, to any person (the "User") obtaining a copy of this software and associated documentation files (the "Software"), to deal in the Software without restriction, including without limitation the rights to use, copy, modify, merge, publish, distribute, and/or sell copies of the Software, and to permit persons to whom the Software is furnished to do so, subject to the following conditions:

1. The above copyright notices and this permission notice (which includes the disclaimer below) shall be included in all copies or substantial portions of the Software.

2. The name of a copyright holder shall not be used to endorse or promote products derived from the Software without specific prior written permission.

THIS DISCLAIMER OF WARRANTY CONSTITUTES AN ESSENTIAL PART OF THIS LICENSE. NO USE OF THE SOFTWARE IS AUTHORIZED HEREUNDER EXCEPT UNDER THIS DISCLAIMER. THE SOFTWARE IS PROVIDED BY THE COPYRIGHT HOLDERS "AS IS", WITHOUT WARRANTY OF ANY KIND, EXPRESS OR IMPLIED, INCLUDING BUT NOT LIMITED TO THE WARRANTIES OF MERCHANTABILITY, FITNESS FOR A PARTICULAR PURPOSE AND NONINFRINGEMENT OF THIRD PARTY RIGHTS. IN NO EVENT SHALL THE COPYRIGHT HOLDERS BE LIABLE FOR ANY CLAIM, OR ANY SPECIAL INDIRECT OR CONSEQUENTIAL DAMAGES, OR ANY DAMAGES WHATSOEVER RESULTING FROM LOSS OF USE, DATA OR PROFITS, WHETHER IN AN ACTION OF CONTRACT, NEGLIGENCE OR OTHER TORTIOUS ACTION, ARISING OUT OF OR IN CONNECTION WITH THE USE OR PERFORMANCE OF THIS SOFTWARE. NO ASSURANCES ARE PROVIDED BY THE COPYRIGHT HOLDERS THAT THE SOFTWARE DOES NOT INFRINGE THE PATENT OR OTHER INTELLECTUAL PROPERTY RIGHTS OF ANY OTHER ENTITY. EACH COPYRIGHT HOLDER DISCLAIMS ANY LIABILITY TO THE USER FOR CLAIMS BROUGHT BY ANY OTHER ENTITY BASED ON INFRINGEMENT OF INTELLECTUAL PROPERTY RIGHTS OR OTHERWISE. AS A CONDITION TO EXERCISING THE RIGHTS GRANTED HEREUNDER, EACH USER HEREBY ASSUMES SOLE RESPONSIBILITY TO SECURE ANY OTHER INTELLECTUAL PROPERTY RIGHTS NEEDED, IF ANY. THE SOFTWARE IS NOT FAULT-TOLERANT AND IS NOT INTENDED FOR USE IN MISSION-CRITICAL SYSTEMS, SUCH AS THOSE USED IN THE OPERATION OF NUCLEAR FACILITIES, AIRCRAFT NAVIGATION OR COMMUNICATION SYSTEMS, AIR TRAFFIC CONTROL SYSTEMS, DIRECT LIFE SUPPORT MACHINES, OR WEAPONS SYSTEMS, IN WHICH THE FAILURE OF THE SOFTWARE OR SYSTEM COULD LEAD DIRECTLY TO DEATH, PERSONAL INJURY, OR SEVERE PHYSICAL OR ENVIRONMENTAL DAMAGE ("HIGH RISK ACTIVITIES"). THE COPYRIGHT HOLDERS SPECIFICALLY DISCLAIM ANY

EXPRESS OR IMPLIED WARRANTY OF FITNESS FOR HIGH RISK ACTIVITIES.

(jasper/doc/\*.pdf have been removed since their corresponding sources are not available - ed.)

For files in the jbig2dec directory:

The files in this directory (folder) and any subdirectories (sub-folders) thereof are part of jbig2dec, with the exception of certain source files included to support portability which are marked otherwise in their copyright headers.

jbig2dec is free software; you can redistribute it and/or modify it under the terms of version 2 of the GNU General Public License as published by the Free Software Foundation.

This software is distributed in the hope that it will be useful, but WITHOUT ANY WARRANTY; without even the implied warranty of MERCHANTABILITY or FITNESS FOR A PARTICULAR PURPOSE. See the GNU General Public License for more details.

You should have received a copy of the GNU General Public License along with this program in the file named COPYING. If not, write to the Free Software Foundation, Inc., 51 Franklin Street, Fifth Floor, Boston, MA 02110-1301, USA.

In addition, specific permission is given to link jbig2dec to or compile jbig2dec into AFPL Ghostscript and to distribute same under the AFPL license.

For files in the jpeg directory:

(Quoted from jpeg/README)

#### LEGAL ISSUES

=====

The authors make NO WARRANTY or representation, either express or implied, with respect to this software, its quality, accuracy, merchantability, or fitness for a particular purpose. This software is provided "AS IS", and you, its user, assume the entire risk as to its quality and accuracy.

This software is copyright (C) 1991-1998, Thomas G. Lane. All Rights Reserved except as specified below.

Permission is hereby granted to use, copy, modify, and distribute this software (or portions thereof) for any purpose, without fee, subject to these conditions: (1) If any part of the source code for this software is distributed, then this README file must be included, with this copyright and no-warranty notice unaltered; and any additions, deletions, or changes to the original files must be clearly indicated in accompanying documentation. (2) If only executable code is distributed, then the accompanying documentation must state that "this software is based in part on the work of the Independent JPEG Group". (3) Permission for use of this software is granted only if the user accepts full responsibility for any undesirable consequences; the authors accept NO LIABILITY for damages of any kind.

These conditions apply to any software derived from or based on the IJG code, not just to the unmodified library. If you use our work, you ought to acknowledge us.

Permission is NOT granted for the use of any IJG author's name or company

name in advertising or publicity relating to this software or products derived from it. This software may be referred to only as "the Independent JPEG Group's software".

We specifically permit and encourage the use of this software as the basis of commercial products, provided that all warranty or liability claims are assumed by the product vendor.

ansi2knr.c is included in this distribution by permission of L. Peter Deutsch, sole proprietor of its copyright holder, Aladdin Enterprises of Menlo Park, CA. ansi2knr.c is NOT covered by the above copyright and conditions, but instead by the usual distribution terms of the Free Software Foundation; principally, that you must include source code if you redistribute it. (See the file ansi2knr.c for full details.) However, since ansi2knr.c is not needed as part of any program generated from the IJG code, this does not limit you more than the foregoing paragraphs do.

The Unix configuration script "configure" was produced with GNU Autoconf. It is copyright by the Free Software Foundation but is freely distributable. The same holds for its supporting scripts (config.guess, config.sub, ltconfig, ltmain.sh). Another support script, install-sh, is copyright by M.I.T. but is also freely distributable.

It appears that the arithmetic coding option of the JPEG spec is covered by patents owned by IBM, AT&T, and Mitsubishi. Hence arithmetic coding cannot legally be used without obtaining one or more licenses. For this reason, support for arithmetic coding has been removed from the free JPEG software. (Since arithmetic coding provides only a marginal gain over the unpatented Huffman mode, it is unlikely that very many implementations will support it.) So far as we are aware, there are no patent restrictions on the remaining code.

The IJG distribution formerly included code to read and write GIF files. To avoid entanglement with the Unisys LZW patent, GIF reading support has been removed altogether, and the GIF writer has been simplified to produce "uncompressed GIFs". This technique does not use the LZW algorithm; the resulting GIF files are larger than usual, but are readable by all standard GIF decoders.

We are required to state that "The Graphics Interchange Format(c) is the Copyright property of CompuServe Incorporated. GIF(sm) is a Service Mark property of CompuServe Incorporated."

(The LZW Patent is now void - ed.)

For files in the libpng directory:

This copy of the libpng notices is provided for your convenience. In case of any discrepancy between this copy and the notices in the file png.h that is included in the libpng distribution, the latter shall prevail.

COPYRIGHT NOTICE, DISCLAIMER, and LICENSE:

If you modify libpng you may insert additional notices immediately following this sentence.

libpng versions 1.2.6, August 15, 2004, through 1.2.18, May 15, 2007, are Copyright (c) 2004, 2006-2007 Glenn Randers-Pehrson, and are distributed according to the same disclaimer and license as libpng-1.2.5 with the following individual added to the list of Contributing Authors

Cosmin Truta

libpng versions 1.0.7, July 1, 2000, through 1.2.5 - October 3, 2002, are Copyright (c) 2000-2002 Glenn Randers-Pehrson, and are distributed according to the same disclaimer and license as libpng-1.0.6 with the following individuals added to the list of Contributing Authors

Simon-Pierre Cadieux  
Eric S. Raymond  
Gilles Vollant

and with the following additions to the disclaimer:

There is no warranty against interference with your enjoyment of the library or against infringement. There is no warranty that our efforts or the library will fulfill any of your articular purposes or needs. This library is provided with all faults, and the entire risk of satisfactory quality, performance, accuracy, and effort is with the user.

libpng versions 0.97, January 1998, through 1.0.6, March 20, 2000, are Copyright (c) 1998, 1999 Glenn Randers-Pehrson, and are distributed according to the same disclaimer and license as libpng-0.96, with the following individuals added to the list of Contributing Authors:

Tom Lane  
Glenn Randers-Pehrson  
Willem van Schaik

libpng versions 0.89, June 1996, through 0.96, May 1997, are Copyright (c) 1996, 1997 Andreas Dilger Distributed according to the same disclaimer and license as libpng-0.88, with the following individuals added to the list of Contributing Authors:

John Bowler  
Kevin Bracey  
Sam Bushell  
Magnus Holmgren  
Greg Roelofs  
Tom Tanner

libpng versions 0.5, May 1995, through 0.88, January 1996, are Copyright (c) 1995, 1996 Guy Eric Schalnat, Group 42, Inc.

For the purposes of this copyright and license, "Contributing Authors" is defined as the following set of individuals:

Andreas Dilger  
Dave Martindale  
Guy Eric Schalnat  
Paul Schmidt  
Tim Wegner

The PNG Reference Library is supplied "AS IS". The Contributing Authors and Group 42, Inc. disclaim all warranties, expressed or implied, including, without limitation, the warranties of merchantability and of fitness for any purpose. The Contributing Authors and Group 42, Inc. assume no liability for direct, indirect, incidental, special, exemplary, or consequential damages, which may result from

the use of the PNG Reference Library, even if advised of the possibility of such damage.

Permission is hereby granted to use, copy, modify, and distribute this source code, or portions hereof, for any purpose, without fee, subject to the following restrictions:

1. The origin of this source code must not be misrepresented.
2. Altered versions must be plainly marked as such and must not be misrepresented as being the original source.
3. This Copyright notice may not be removed or altered from any source or altered source distribution.

The Contributing Authors and Group 42, Inc. specifically permit, without fee, and encourage the use of this source code as a component to supporting the PNG file format in commercial products. If you use this source code in a product, acknowledgment is not required but would be appreciated.

A "png\_get\_copyright" function is available, for convenient use in "about" boxes and the like:

```
printf("%s",png_get_copyright(NULL));
```

Also, the PNG logo (in PNG format, of course) is supplied in the files "pngbar.png" and "pngbar.jpg (88x31) and "pngnow.png" (98x31).

Libpng is OSI Certified Open Source Software. OSI Certified Open Source is a certification mark of the Open Source Initiative.

Glenn Randers-Pehrson  
glennrp at users.sourceforge.net  
May 15, 2007

For files in the zlib directory:

Copyright (C) 1995-2005 Jean-loup Gailly and Mark Adler

This software is provided 'as-is', without any express or implied warranty. In no event will the authors be held liable for any damages arising from the use of this software.

Permission is granted to anyone to use this software for any purpose, including commercial applications, and to alter it and redistribute it freely, subject to the following restrictions:

1. The origin of this software must not be misrepresented; you must not claim that you wrote the original software. If you use this software in a product, an acknowledgment in the product documentation would be appreciated but is not required.
2. Altered source versions must be plainly marked as such, and must not be misrepresented as being the original software.
3. This notice may not be removed or altered from any source distribution.

Jean-loup Gailly            Mark Adler  
jloup@gzip.org            madler@alumni.caltech.edu

The data format used by the zlib library is described by RFCs (Request for Comments) 1950 to 1952 in the files <http://www.ietf.org/rfc/rfc1950.txt> (zlib format), [rfc1951.txt](http://www.ietf.org/rfc/rfc1951.txt) (deflate format) and [rfc1952.txt](http://www.ietf.org/rfc/rfc1952.txt) (gzip format).

---

## GNU GENERAL PUBLIC LICENSE

Version 2, June 1991

Copyright (C) 1989, 1991 Free Software Foundation, Inc.

51 Franklin Street, Fifth Floor, Boston, MA 02110-1301, USA

Everyone is permitted to copy and distribute verbatim copies of this license document, but changing it is not allowed.

### Preamble

The licenses for most software are designed to take away your freedom to share and change it. By contrast, the GNU General Public License is intended to guarantee your freedom to share and change free software--to make sure the software is free for all its users. This General Public License applies to most of the Free Software Foundation's software and to any other program whose authors commit to using it. (Some other Free Software Foundation software is covered by the GNU Lesser General Public License instead.) You can apply it to your programs, too.

When we speak of free software, we are referring to freedom, not price. Our General Public Licenses are designed to make sure that you have the freedom to distribute copies of free software (and charge for this service if you wish), that you receive source code or can get it if you want it, that you can change the software or use pieces of it in new free programs; and that you know you can do these things.

To protect your rights, we need to make restrictions that forbid anyone to deny you these rights or to ask you to surrender the rights. These restrictions translate to certain responsibilities for you if you distribute copies of the software, or if you modify it.

For example, if you distribute copies of such a program, whether gratis or for a fee, you must give the recipients all the rights that you have. You must make sure that they, too, receive or can get the source code. And you must show them these terms so they know their rights.

We protect your rights with two steps: (1) copyright the software, and (2) offer you this license which gives you legal permission to copy, distribute and/or modify the software.

Also, for each author's protection and ours, we want to make certain that everyone understands that there is no warranty for this free software. If the software is modified by someone else and passed on, we want its recipients to know that what they have is not the original, so that any problems introduced by others will not reflect on the original authors' reputations.

Finally, any free program is threatened constantly by software patents. We wish to avoid the danger that redistributors of a free program will individually obtain patent licenses, in effect making the program proprietary. To prevent this, we have made it clear that any patent must be licensed for everyone's free use or not licensed at all.

The precise terms and conditions for copying, distribution and modification follow.

#### TERMS AND CONDITIONS FOR COPYING, DISTRIBUTION AND MODIFICATION

0. This License applies to any program or other work which contains a notice placed by the copyright holder saying it may be distributed under the terms of this General Public License. The "Program", below, refers to any such program or work, and a "work based on the Program" means either the Program or any derivative work under copyright law: that is to say, a work containing the Program or a portion of it, either verbatim or with modifications and/or translated into another language. (Hereinafter, translation is included without limitation in the term "modification".) Each licensee is addressed as "you".

Activities other than copying, distribution and modification are not covered by this License; they are outside its scope. The act of running the Program is not restricted, and the output from the Program is covered only if its contents constitute a work based on the Program (independent of having been made by running the Program). Whether that is true depends on what the Program does.

1. You may copy and distribute verbatim copies of the Program's source code as you receive it, in any medium, provided that you conspicuously and appropriately publish on each copy an appropriate copyright notice and disclaimer of warranty; keep intact all the notices that refer to this License and to the absence of any warranty; and give any other recipients of the Program a copy of this License along with the Program.

You may charge a fee for the physical act of transferring a copy, and you may at your option offer warranty protection in exchange for a fee.

2. You may modify your copy or copies of the Program or any portion of it, thus forming a work based on the Program, and copy and distribute such modifications or work under the terms of Section 1 above, provided that you also meet all of these conditions:

- a) You must cause the modified files to carry prominent notices stating that you changed the files and the date of any change.
- b) You must cause any work that you distribute or publish, that in whole or in part contains or is derived from the Program or any part thereof, to be licensed as a whole at no charge to all third parties under the terms of this License.
- c) If the modified program normally reads commands interactively when run, you must cause it, when started running for such interactive use in the most ordinary way, to print or display an announcement including an appropriate copyright notice and a notice that there is no warranty (or else, saying that you provide a warranty) and that users may redistribute the program under these conditions, and telling the user how to view a copy of this License. (Exception: if the Program itself is interactive but does not normally print such an announcement, your work based on the Program is not required to print an announcement.)

These requirements apply to the modified work as a whole. If identifiable sections of that work are not derived from the Program, and can be reasonably considered independent and separate works in themselves, then this License, and its terms, do not apply to those sections when you distribute them as separate works. But when you distribute the same sections as part of a whole which is a work based on the Program, the distribution of the whole must be on the terms of this License, whose permissions for other licensees extend to the entire whole, and thus to each and every part regardless of who wrote it.

Thus, it is not the intent of this section to claim rights or contest your rights to work written entirely by you; rather, the intent is to exercise the right to control the distribution of derivative or collective works based on the Program.



In addition, mere aggregation of another work not based on the Program with the Program (or with a work based on the Program) on a volume of a storage or distribution medium does not bring the other work under the scope of this License.

3. You may copy and distribute the Program (or a work based on it, under Section 2) in object code or executable form under the terms of Sections 1 and 2 above provided that you also do one of the following:

- a) Accompany it with the complete corresponding machine-readable source code, which must be distributed under the terms of Sections 1 and 2 above on a medium customarily used for software interchange; or,
- b) Accompany it with a written offer, valid for at least three years, to give any third party, for a charge no more than your cost of physically performing source distribution, a complete machine-readable copy of the corresponding source code, to be distributed under the terms of Sections 1 and 2 above on a medium customarily used for software interchange; or,
- c) Accompany it with the information you received as to the offer to distribute corresponding source code. (This alternative is allowed only for noncommercial distribution and only if you received the program in object code or executable form with such an offer, in accord with Subsection b above.)

The source code for a work means the preferred form of the work for making modifications to it. For an executable work, complete source code means all the source code for all modules it contains, plus any associated interface definition files, plus the scripts used to control compilation and installation of the executable. However, as a special exception, the source code distributed need not include anything that is normally distributed (in either source or binary form) with the major components (compiler, kernel, and so on) of the operating system on which the executable runs, unless that component itself accompanies the executable.

If distribution of executable or object code is made by offering access to copy from a designated place, then offering equivalent access to copy the source code from the same place counts as distribution of the source code, even though third parties are not compelled to copy the source along with the object code.

4. You may not copy, modify, sublicense, or distribute the Program except as expressly provided under this License. Any attempt otherwise to copy, modify, sublicense or distribute the Program is void, and will automatically terminate your rights under this License. However, parties who have received copies, or rights, from you under this License will not have their licenses terminated so long as such parties remain in full compliance.

5. You are not required to accept this License, since you have not signed it. However, nothing else grants you permission to modify or distribute the Program or its derivative works. These actions are prohibited by law if you do not accept this License. Therefore, by modifying or distributing the Program (or any work based on the Program), you indicate your acceptance of this License to do so, and all its terms and conditions for copying, distributing or modifying the Program or works based on it.

6. Each time you redistribute the Program (or any work based on the Program), the recipient automatically receives a license from the original licensor to copy, distribute or modify the Program subject to these terms and conditions. You may not impose any further restrictions on the recipients' exercise of the rights granted herein. You are not responsible for enforcing compliance by third parties to this License.



7. If, as a consequence of a court judgment or allegation of patent infringement or for any other reason (not limited to patent issues), conditions are imposed on you (whether by court order, agreement or otherwise) that contradict the conditions of this License, they do not excuse you from the conditions of this License. If you cannot distribute so as to satisfy simultaneously your obligations under this License and any other pertinent obligations, then as a consequence you may not distribute the Program at all. For example, if a patent license would not permit royalty-free redistribution of the Program by all those who receive copies directly or indirectly through you, then the only way you could satisfy both it and this License would be to refrain entirely from distribution of the Program.

If any portion of this section is held invalid or unenforceable under any particular circumstance, the balance of the section is intended to apply and the section as a whole is intended to apply in other circumstances.

It is not the purpose of this section to induce you to infringe any patents or other property right claims or to contest validity of any such claims; this section has the sole purpose of protecting the integrity of the free software distribution system, which is implemented by public license practices. Many people have made generous contributions to the wide range of software distributed through that system in reliance on consistent application of that system; it is up to the author/donor to decide if he or she is willing to distribute software through any other system and a licensee cannot impose that choice.

This section is intended to make thoroughly clear what is believed to be a consequence of the rest of this License.

8. If the distribution and/or use of the Program is restricted in certain countries either by patents or by copyrighted interfaces, the original copyright holder who places the Program under this License may add an explicit geographical distribution limitation excluding those countries, so that distribution is permitted only in or among countries not thus excluded. In such case, this License incorporates the limitation as if written in the body of this License.

9. The Free Software Foundation may publish revised and/or new versions of the General Public License from time to time. Such new versions will be similar in spirit to the present version, but may differ in detail to address new problems or concerns.

Each version is given a distinguishing version number. If the Program specifies a version number of this License which applies to it and "any later version", you have the option of following the terms and conditions either of that version or of any later version published by the Free Software Foundation. If the Program does not specify a version number of this License, you may choose any version ever published by the Free Software Foundation.

10. If you wish to incorporate parts of the Program into other free programs whose distribution conditions are different, write to the author to ask for permission. For software which is copyrighted by the Free Software Foundation, write to the Free Software Foundation; we sometimes make exceptions for this. Our decision will be guided by the two goals of preserving the free status of all derivatives of our free software and of promoting the sharing and reuse of software generally.

NO WARRANTY

11. BECAUSE THE PROGRAM IS LICENSED FREE OF CHARGE, THERE IS NO WARRANTY FOR THE PROGRAM, TO THE EXTENT PERMITTED BY APPLICABLE

LAW. EXCEPT WHEN OTHERWISE STATED IN WRITING THE COPYRIGHT HOLDERS AND/OR OTHER PARTIES PROVIDE THE PROGRAM "AS IS" WITHOUT WARRANTY OF ANY KIND, EITHER EXPRESSED OR IMPLIED, INCLUDING, BUT NOT LIMITED TO, THE IMPLIED WARRANTIES OF MERCHANTABILITY AND FITNESS FOR A PARTICULAR PURPOSE. THE ENTIRE RISK AS TO THE QUALITY AND PERFORMANCE OF THE PROGRAM IS WITH YOU. SHOULD THE PROGRAM PROVE DEFECTIVE, YOU ASSUME THE COST OF ALL NECESSARY SERVICING, REPAIR OR CORRECTION.

12. IN NO EVENT UNLESS REQUIRED BY APPLICABLE LAW OR AGREED TO IN WRITING WILL ANY COPYRIGHT HOLDER, OR ANY OTHER PARTY WHO MAY MODIFY AND/OR REDISTRIBUTE THE PROGRAM AS PERMITTED ABOVE, BE LIABLE TO YOU FOR DAMAGES, INCLUDING ANY GENERAL, SPECIAL, INCIDENTAL OR CONSEQUENTIAL DAMAGES ARISING OUT OF THE USE OR INABILITY TO USE THE PROGRAM (INCLUDING BUT NOT LIMITED TO LOSS OF DATA OR DATA BEING RENDERED INACCURATE OR LOSSES SUSTAINED BY YOU OR THIRD PARTIES OR A FAILURE OF THE PROGRAM TO OPERATE WITH ANY OTHER PROGRAMS), EVEN IF SUCH HOLDER OR OTHER PARTY HAS BEEN ADVISED OF THE POSSIBILITY OF SUCH DAMAGES.

END OF TERMS AND CONDITIONS

How to Apply These Terms to Your New Programs

If you develop a new program, and you want it to be of the greatest possible use to the public, the best way to achieve this is to make it free software which everyone can redistribute and change under these terms.

To do so, attach the following notices to the program. It is safest to attach them to the start of each source file to most effectively convey the exclusion of warranty; and each file should have at least the "copyright" line and a pointer to where the full notice is found.

one line to give the program's name and an idea of what it does.

Copyright (C) yyyy name of author

This program is free software; you can redistribute it and/or modify it under the terms of the GNU General Public License as published by the Free Software Foundation; either version 2 of the License, or (at your option) any later version.

This program is distributed in the hope that it will be useful, but WITHOUT ANY WARRANTY; without even the implied warranty of MERCHANTABILITY or FITNESS FOR A PARTICULAR PURPOSE. See the GNU General Public License for more details.

You should have received a copy of the GNU General Public License along with this program; if not, write to the Free Software Foundation, Inc., 51 Franklin Street, Fifth Floor, Boston, MA 02110-1301, USA.

Also add information on how to contact you by electronic and paper mail.

If the program is interactive, make it output a short notice like this when it starts in an interactive mode:

Gnomovision version 69, Copyright (C) year name of author

Gnomovision comes with ABSOLUTELY NO WARRANTY; for details type `show w'. This is free software, and you are welcome to redistribute it under certain conditions; type `show c' for details.

The hypothetical commands ``show w'` and ``show c'` should show the appropriate parts of the General Public License. Of course, the commands you use may be called something other than ``show w'` and ``show c'`; they could even be mouse-clicks or menu items--whatever suits your program.

You should also get your employer (if you work as a programmer) or your school, if any, to sign a "copyright disclaimer" for the program, if necessary. Here is a sample; alter the names:

Yoyodyne, Inc., hereby disclaims all copyright interest in the program ``Gnomovision'` (which makes passes at compilers) written by James Hacker.

signature of Ty Coon, 1 April 1989

Ty Coon, President of Vice

This General Public License does not permit incorporating your program into proprietary programs. If your program is a subroutine library, you may consider it more useful to permit linking proprietary applications with the library. If this is what you want to do, use the GNU Lesser General Public License instead of this License.

## ❑ ImageMagick

Before we get to the text of the license lets just review what the license says in simple terms:

It allows you to:

- freely download and use ImageMagick software, in whole or in part, for personal, company internal, or commercial purposes;
- use ImageMagick software in packages or distributions that you create.

It forbids you to:

- redistribute any piece of ImageMagick-originated software without proper attribution;
- use any marks owned by ImageMagick Studio LLC in any way that might state or imply that ImageMagick Studio LLC endorses your distribution;
- use any marks owned by ImageMagick Studio LLC in any way that might state or imply that you created the ImageMagick software in question.

It requires you to:

- include a copy of the license in any redistribution you may make that includes ImageMagick software;
- provide clear attribution to ImageMagick Studio LLC for any distributions that include ImageMagick software.

It does not require you to:

- include the source of the ImageMagick software itself, or of any modifications you may have made to it, in any redistribution you may assemble that includes it;
- submit changes that you make to the software back to the ImageMagick Studio LLC (though such feedback is encouraged).

A few other clarifications include:

- ImageMagick is freely available without charge;
- you may include ImageMagick on a DVD as long as you comply with the terms of the license;
- you can give modified code away for free or sell it under the terms of the ImageMagick license or distribute the result under a different license, but you need to acknowledge the use of the ImageMagick software;
- the license is compatible with the GPL.

The legally binding and authoritative terms and conditions for use, reproduction, and distribution of ImageMagick follow:

Copyright 1999-2007 ImageMagick Studio LLC, a non-profit organization dedicated to making software imaging solutions freely available.

#### 1. Definitions.

License shall mean the terms and conditions for use, reproduction, and distribution as defined by Sections 1 through 9 of this document.

Licensors shall mean the copyright owner or entity authorized by the copyright owner that is granting the License.

Legal Entity shall mean the union of the acting entity and all other entities that control, are controlled by, or are under common control with that entity. For the purposes of this definition, control means (i) the power, direct or indirect, to cause the direction or management of such entity, whether by contract or otherwise, or (ii) ownership of fifty percent (50%) or more of the outstanding shares, or (iii) beneficial ownership of such entity.

You (or Your) shall mean an individual or Legal Entity exercising permissions granted by this License.

Source form shall mean the preferred form for making modifications, including but not limited to software source code, documentation source, and configuration files.

Object form shall mean any form resulting from mechanical transformation or translation of a Source form, including but not limited to compiled object code, generated documentation, and conversions to other media types.

Work shall mean the work of authorship, whether in Source or Object form, made available under the License, as indicated by a copyright notice that is included in or attached to the work (an example is provided in the Appendix below).

Derivative Works shall mean any work, whether in Source or Object form, that is based on (or derived from) the Work and for which the editorial revisions, annotations, elaborations, or other modifications represent, as a whole, an original work of authorship. For the purposes of this License, Derivative Works shall not include works that remain separable from, or merely link (or bind by name) to the interfaces of, the Work and Derivative Works thereof.

Contribution shall mean any work of authorship, including the original version of the Work and any modifications or additions to that Work or Derivative Works thereof, that is intentionally submitted to Licensors for inclusion in the Work by the copyright owner or by an individual or Legal Entity authorized to submit on behalf of the copyright owner. For the purposes of this definition, submitted means any form of electronic, verbal, or written communication intentionally sent to the Licensors by its copyright holder or its representatives, including but not limited to communication on electronic mailing lists, source code control systems, and issue tracking systems that are managed by, or on behalf of, the Licensors for the purpose of discussing and improving the Work, but excluding communication that is conspicuously marked or otherwise designated in writing by the copyright owner as Not a Contribution.

Contributor shall mean Licensors and any individual or Legal Entity on behalf of whom a Contribution has been received by Licensors and subsequently incorporated within the Work.

2. Grant of Copyright License. Subject to the terms and conditions of this License, each Contributor hereby grants to You a perpetual, worldwide, non-exclusive, no-charge, royalty-free, irrevocable copyright license to reproduce, prepare Derivative Works of, publicly display, publicly perform, sublicense, and distribute the Work and such Derivative Works in Source or Object form.

3. Grant of Patent License. Subject to the terms and conditions of this License, each Contributor hereby grants to You a perpetual, worldwide, non-exclusive, no-charge, royalty-free, irrevocable patent license to make, have made, use, offer to sell, sell, import, and otherwise transfer the Work, where such license applies only to those patent claims licensable by such Contributor that are necessarily infringed by their Contribution(s) alone or by combination of their Contribution(s) with the Work to which such Contribution(s) was submitted.

4. Redistribution. You may reproduce and distribute copies of the Work or

Derivative Works thereof in any medium, with or without modifications, and in Source or Object form, provided that You meet the following conditions:

- a. You must give any other recipients of the Work or Derivative Works a copy of this License; and
  - b. You must cause any modified files to carry prominent notices stating that You changed the files; and
  - c. You must retain, in the Source form of any Derivative Works that You distribute, all copyright, patent, trademark, and attribution notices from the Source form of the Work, excluding those notices that do not pertain to any part of the Derivative Works; and
  - d. If the Work includes a NOTICE text file as part of its distribution, then any Derivative Works that You distribute must include a readable copy of the attribution notices contained within such NOTICE file, excluding those notices that do not pertain to any part of the Derivative Works, in at least one of the following places: within a NOTICE text file distributed as part of the Derivative Works; within the Source form or documentation, if provided along with the Derivative Works; or, within a display generated by the Derivative Works, if and wherever such third-party notices normally appear. The contents of the NOTICE file are for informational purposes only and do not modify the License. You may add Your own attribution notices within Derivative Works that You distribute, alongside or as an addendum to the NOTICE text from the Work, provided that such additional attribution notices cannot be construed as modifying the License.
- You may add Your own copyright statement to Your modifications and may provide additional or different license terms and conditions for use, reproduction, or distribution of Your modifications, or for any such Derivative Works as a whole, provided Your use, reproduction, and distribution of the Work otherwise complies with the conditions stated in this License.

5. Submission of Contributions. Unless You explicitly state otherwise, any Contribution intentionally submitted for inclusion in the Work by You to the Licensor shall be under the terms and conditions of this License, without any additional terms or conditions. Notwithstanding the above, nothing herein shall supersede or modify the terms of any separate license agreement you may have executed with Licensor regarding such Contributions.

6. Trademarks. This License does not grant permission to use the trade names, trademarks, service marks, or product names of the Licensor, except as required for reasonable and customary use in describing the origin of the Work and reproducing the content of the NOTICE file.

7. Disclaimer of Warranty. Unless required by applicable law or agreed to in writing, Licensor provides the Work (and each Contributor provides its Contributions) on an AS IS BASIS, WITHOUT WARRANTIES OR CONDITIONS OF ANY KIND, either express or implied, including, without limitation, any warranties or conditions of TITLE, NON-INFRINGEMENT, MERCHANTABILITY, or FITNESS FOR A PARTICULAR PURPOSE. You are solely responsible for determining the appropriateness of using or redistributing the Work and assume any risks associated with Your exercise of permissions under this License.

8. Limitation of Liability. In no event and under no legal theory, whether in tort (including negligence), contract, or otherwise, unless required by applicable law (such as deliberate and grossly negligent acts) or agreed to in writing, shall any Contributor be liable to You for damages, including any direct, indirect, special, incidental, or consequential damages of any character arising as a result of this License or out of the use or inability to use the Work (including but not limited to damages for loss of goodwill, work stoppage, computer failure or malfunction, or any and all other commercial damages or losses), even if such Contributor has been advised of the possibility of such damages.

9. Accepting Warranty or Additional Liability. While redistributing the Work or Derivative Works thereof, You may choose to offer, and charge a fee for, acceptance of support, warranty, indemnity, or other liability obligations and/or

rights consistent with this License.

APPENDIX: How to apply the ImageMagick License to your work

To apply the ImageMagick License to your work, attach the following boilerplate notice, with the fields enclosed by brackets "[ ]" replaced with your own identifying information. (Don't include the brackets!) The text should be enclosed in the appropriate comment syntax for the file format.

Copyright [yyyy] [name of copyright owner]

Licensed under the ImageMagick License (the "License"); you may not use this file except in compliance with the License. You may obtain a copy of the License at

<http://www.imagemagick.org/www/license.html>

Unless required by applicable law or agreed to in writing, software distributed under the License is distributed on an "AS IS" BASIS, WITHOUT WARRANTIES OR CONDITIONS OF ANY KIND, either express or implied. See the License for the specific language governing permissions and limitations under the License.

## □ libjpg

GNU GENERAL PUBLIC LICENSE

Version 3, 29 June 2007

Copyright (C) 2007 Free Software Foundation, Inc. <<http://fsf.org/>>

Everyone is permitted to copy and distribute verbatim copies of this license document, but changing it is not allowed.

Preamble

The GNU General Public License is a free, copyleft license for software and other kinds of works.

The licenses for most software and other practical works are designed to take away your freedom to share and change the works. By contrast, the GNU General Public License is intended to guarantee your freedom to share and change all versions of a program--to make sure it remains free software for all its users. We, the Free Software Foundation, use the GNU General Public License for most of our software; it applies also to any other work released this way by its authors. You can apply it to your programs, too.

When we speak of free software, we are referring to freedom, not price. Our General Public Licenses are designed to make sure that you have the freedom to distribute copies of free software (and charge for them if you wish), that you receive source code or can get it if you want it, that you can change the software or use pieces of it in new free programs, and that you know you can do these things.

To protect your rights, we need to prevent others from denying you these rights or asking you to surrender the rights. Therefore, you have certain responsibilities if you distribute copies of the software, or if you modify it: responsibilities to respect the freedom of others.

For example, if you distribute copies of such a program, whether gratis or for a fee, you must pass on to the recipients the same freedoms that you received. You must make sure that they, too, receive or can get the source code. And you must show them these terms so they know their rights.

Developers that use the GNU GPL protect your rights with two steps: (1) assert



copyright on the software, and (2) offer you this License giving you legal permission to copy, distribute and/or modify it.

For the developers' and authors' protection, the GPL clearly explains that there is no warranty for this free software. For both users' and authors' sake, the GPL requires that modified versions be marked as changed, so that their problems will not be attributed erroneously to authors of previous versions.

Some devices are designed to deny users access to install or run modified versions of the software inside them, although the manufacturer can do so. This is fundamentally incompatible with the aim of protecting users' freedom to change the software. The systematic pattern of such abuse occurs in the area of products for individuals to use, which is precisely where it is most unacceptable. Therefore, we have designed this version of the GPL to prohibit the practice for those products. If such problems arise substantially in other domains, we stand ready to extend this provision to those domains in future versions of the GPL, as needed to protect the freedom of users.

Finally, every program is threatened constantly by software patents. States should not allow patents to restrict development and use of software on general-purpose computers, but in those that do, we wish to avoid the special danger that patents applied to a free program could make it effectively proprietary. To prevent this, the GPL assures that patents cannot be used to render the program non-free.

The precise terms and conditions for copying, distribution and modification follow.

## TERMS AND CONDITIONS

### 0. Definitions.

"This License" refers to version 3 of the GNU General Public License.

"Copyright" also means copyright-like laws that apply to other kinds of works, such as semiconductor masks.

"The Program" refers to any copyrightable work licensed under this License. Each licensee is addressed as "you". "Licensees" and "recipients" may be individuals or organizations.

To "modify" a work means to copy from or adapt all or part of the work in a fashion requiring copyright permission, other than the making of an exact copy. The resulting work is called a "modified version" of the earlier work or a work "based on" the earlier work.

A "covered work" means either the unmodified Program or a work based on the Program.

To "propagate" a work means to do anything with it that, without permission, would make you directly or secondarily liable for infringement under applicable copyright law, except executing it on a computer or modifying a private copy. Propagation includes copying, distribution (with or without modification), making available to the public, and in some countries other activities as well.

To "convey" a work means any kind of propagation that enables other parties to make or receive copies. Mere interaction with a user through a computer network, with no transfer of a copy, is not conveying.

An interactive user interface displays "Appropriate Legal Notices" to the extent that it includes a convenient and prominently visible feature that (1) displays an appropriate copyright notice, and (2) tells the user that there is no warranty for the work (except to the extent that warranties are provided), that licensees may convey the work under this License, and how to view a copy of this License. If the interface presents a list of user commands or options, such as a menu, a prominent item in the list meets this criterion.

## 1. Source Code.

The "source code" for a work means the preferred form of the work for making modifications to it. "Object code" means any non-source form of a work.

A "Standard Interface" means an interface that either is an official standard defined by a recognized standards body, or, in the case of interfaces specified for a particular programming language, one that is widely used among developers working in that language.

The "System Libraries" of an executable work include anything, other than the work as a whole, that (a) is included in the normal form of packaging a Major Component, but which is not part of that Major Component, and (b) serves only to enable use of the work with that Major Component, or to implement a Standard Interface for which an implementation is available to the public in source code form. A "Major Component", in this context, means a major essential component (kernel, window system, and so on) of the specific operating system (if any) on which the executable work runs, or a compiler used to produce the work, or an object code interpreter used to run it.

The "Corresponding Source" for a work in object code form means all the source code needed to generate, install, and (for an executable work) run the object code and to modify the work, including scripts to control those activities. However, it does not include the work's System Libraries, or general-purpose tools or generally available free programs which are used unmodified in performing those activities but which are not part of the work. For example, Corresponding Source includes interface definition files associated with source files for the work, and the source code for shared libraries and dynamically linked subprograms that the work is specifically designed to require, such as by intimate data communication or control flow between those subprograms and other parts of the work.

The Corresponding Source need not include anything that users can regenerate automatically from other parts of the Corresponding Source.

The Corresponding Source for a work in source code form is that same work.

## 2. Basic Permissions.

All rights granted under this License are granted for the term of copyright on the Program, and are irrevocable provided the stated conditions are met. This License explicitly affirms your unlimited permission to run the unmodified Program. The output from running a covered work is covered by this License only if the output, given its content, constitutes a covered work. This License acknowledges your rights of fair use or other equivalent, as provided by copyright law.

You may make, run and propagate covered works that you do not convey, without conditions so long as your license otherwise remains in force. You may convey covered works to others for the sole purpose of having them make modifications exclusively for you, or provide you with facilities for running those works, provided that you comply with the terms of this License in conveying all material for which



you do not control copyright. Those thus making or running the covered works for you must do so exclusively on your behalf, under your direction and control, on terms that prohibit them from making any copies of your copyrighted material outside their relationship with you.

Conveying under any other circumstances is permitted solely under the conditions stated below. Sublicensing is not allowed; section 10 makes it unnecessary.

### 3. Protecting Users' Legal Rights From Anti-Circumvention Law.

No covered work shall be deemed part of an effective technological measure under any applicable law fulfilling obligations under article 11 of the WIPO copyright treaty adopted on 20 December 1996, or similar laws prohibiting or restricting circumvention of such measures.

When you convey a covered work, you waive any legal power to forbid circumvention of technological measures to the extent such circumvention is effected by exercising rights under this License with respect to the covered work, and you disclaim any intention to limit operation or modification of the work as a means of enforcing, against the work's users, your or third parties' legal rights to forbid circumvention of technological measures.

### 4. Conveying Verbatim Copies.

You may convey verbatim copies of the Program's source code as you receive it, in any medium, provided that you conspicuously and appropriately publish on each copy an appropriate copyright notice; keep intact all notices stating that this License and any non-permissive terms added in accord with section 7 apply to the code; keep intact all notices of the absence of any warranty; and give all recipients a copy of this License along with the Program.

You may charge any price or no price for each copy that you convey, and you may offer support or warranty protection for a fee.

### 5. Conveying Modified Source Versions.

You may convey a work based on the Program, or the modifications to produce it from the Program, in the form of source code under the terms of section 4, provided that you also meet all of these conditions:

a) The work must carry prominent notices stating that you modified it, and giving a relevant date.

b) The work must carry prominent notices stating that it is released under this License and any conditions added under section 7. This requirement modifies the requirement in section 4 to "keep intact all notices".

c) You must license the entire work, as a whole, under this License to anyone who comes into possession of a copy. This License will therefore apply, along with any applicable section 7 additional terms, to the whole of the work, and all its parts, regardless of how they are packaged. This License gives no permission to license the work in any other way, but it does not invalidate such permission if you have separately received it.

d) If the work has interactive user interfaces, each must display Appropriate Legal Notices; however, if the Program has interactive interfaces that do not display Appropriate Legal Notices, your work need not make them do so.

A compilation of a covered work with other separate and independent works, which are not by their nature extensions of the covered work, and which are not combined with it such as to form a larger program, in or on a volume of a storage or distribution medium, is called an "aggregate" if the compilation and its resulting copyright are not used to limit the access or legal rights of the compilation's users beyond what the individual works permit. Inclusion of a covered work in an aggregate does not cause this License to apply to the other parts of the aggregate.

## 6. Conveying Non-Source Forms.

You may convey a covered work in object code form under the terms of sections 4 and 5, provided that you also convey the machine-readable Corresponding Source under the terms of this License, in one of these ways:

a) Convey the object code in, or embodied in, a physical product (including a physical distribution medium), accompanied by the Corresponding Source fixed on a durable physical medium customarily used for software interchange.

b) Convey the object code in, or embodied in, a physical product (including a physical distribution medium), accompanied by a written offer, valid for at least three years and valid for as long as you offer spare parts or customer support for that product model, to give anyone who possesses the object code either (1) a copy of the Corresponding Source for all the software in the product that is covered by this License, on a durable physical medium customarily used for software interchange, for a price no more than your reasonable cost of physically performing this conveying of source, or (2) access to copy the Corresponding Source from a network server at no charge.

c) Convey individual copies of the object code with a copy of the written offer to provide the Corresponding Source. This alternative is allowed only occasionally and noncommercially, and only if you received the object code with such an offer, in accord with subsection 6b.

d) Convey the object code by offering access from a designated place (gratis or for a charge), and offer equivalent access to the Corresponding Source in the same way through the same place at no further charge. You need not require recipients to copy the Corresponding Source along with the object code. If the place to copy the object code is a network server, the Corresponding Source may be on a different server (operated by you or a third party) that supports equivalent copying facilities, provided you maintain clear directions next to the object code saying where to find the Corresponding Source. Regardless of what server hosts the Corresponding Source, you remain obligated to ensure that it is available for as long as needed to satisfy these requirements.

e) Convey the object code using peer-to-peer transmission, provided you inform other peers where the object code and Corresponding Source of the work are being offered to the general public at no charge under subsection 6d.

A separable portion of the object code, whose source code is excluded from the Corresponding Source as a System Library, need not be included in conveying the object code work.

A "User Product" is either (1) a "consumer product", which means any tangible personal property which is normally used for personal, family, or household purposes, or (2) anything designed or sold for incorporation into a dwelling. In determining whether a product is a consumer product, doubtful cases shall be resolved in favor of coverage. For a particular product received by a particular

user, "normally used" refers to a typical or common use of that class of product, regardless of the status of the particular user or of the way in which the particular user actually uses, or expects or is expected to use, the product. A product is a consumer product regardless of whether the product has substantial commercial, industrial or non-consumer uses, unless such uses represent the only significant mode of use of the product.

"Installation Information" for a User Product means any methods, procedures, authorization keys, or other information required to install and execute modified versions of a covered work in that User Product from a modified version of its Corresponding Source. The information must suffice to ensure that the continued functioning of the modified object code is in no case prevented or interfered with solely because modification has been made.

If you convey an object code work under this section in, or with, or specifically for use in, a User Product, and the conveying occurs as part of a transaction in which the right of possession and use of the User Product is transferred to the recipient in perpetuity or for a fixed term (regardless of how the transaction is characterized), the Corresponding Source conveyed under this section must be accompanied by the Installation Information. But this requirement does not apply if neither you nor any third party retains the ability to install modified object code on the User Product (for example, the work has been installed in ROM).

The requirement to provide Installation Information does not include a requirement to continue to provide support service, warranty, or updates for a work that has been modified or installed by the recipient, or for the User Product in which it has been modified or installed. Access to a network may be denied when the modification itself materially and adversely affects the operation of the network or violates the rules and protocols for communication across the network.

Corresponding Source conveyed, and Installation Information provided, in accord with this section must be in a format that is publicly documented (and with an implementation available to the public in source code form), and must require no special password or key for unpacking, reading or copying.

## 7. Additional Terms.

"Additional permissions" are terms that supplement the terms of this License by making exceptions from one or more of its conditions. Additional permissions that are applicable to the entire Program shall be treated as though they were included in this License, to the extent that they are valid under applicable law. If additional permissions apply only to part of the Program, that part may be used separately under those permissions, but the entire Program remains governed by this License without regard to the additional permissions.

When you convey a copy of a covered work, you may at your option remove any additional permissions from that copy, or from any part of it. (Additional permissions may be written to require their own removal in certain cases when you modify the work.) You may place additional permissions on material, added by you to a covered work, for which you have or can give appropriate copyright permission.

Notwithstanding any other provision of this License, for material you add to a covered work, you may (if authorized by the copyright holders of that material) supplement the terms of this License with terms:

- a) Disclaiming warranty or limiting liability differently from the terms of sections 15 and 16 of this License; or

b) Requiring preservation of specified reasonable legal notices or author attributions in that material or in the Appropriate Legal Notices displayed by works containing it; or

c) Prohibiting misrepresentation of the origin of that material, or requiring that modified versions of such material be marked in reasonable ways as different from the original version; or

d) Limiting the use for publicity purposes of names of licensors or authors of the material; or

e) Declining to grant rights under trademark law for use of some trade names, trademarks, or service marks; or

f) Requiring indemnification of licensors and authors of that material by anyone who conveys the material (or modified versions of it) with contractual assumptions of liability to the recipient, for any liability that these contractual assumptions directly impose on those licensors and authors.

All other non-permissive additional terms are considered "further restrictions" within the meaning of section 10. If the Program as you received it, or any part of it, contains a notice stating that it is governed by this License along with a term that is a further restriction, you may remove that term. If a license document contains a further restriction but permits relicensing or conveying under this License, you may add to a covered work material governed by the terms of that license document, provided that the further restriction does not survive such relicensing or conveying.

If you add terms to a covered work in accord with this section, you must place, in the relevant source files, a statement of the additional terms that apply to those files, or a notice indicating where to find the applicable terms.

Additional terms, permissive or non-permissive, may be stated in the form of a separately written license, or stated as exceptions; the above requirements apply either way.

## 8. Termination.

You may not propagate or modify a covered work except as expressly provided under this License. Any attempt otherwise to propagate or modify it is void, and will automatically terminate your rights under this License (including any patent licenses granted under the third paragraph of section 11).

However, if you cease all violation of this License, then your license from a particular copyright holder is reinstated (a) provisionally, unless and until the copyright holder explicitly and finally terminates your license, and (b) permanently, if the copyright holder fails to notify you of the violation by some reasonable means prior to 60 days after the cessation.

Moreover, your license from a particular copyright holder is reinstated permanently if the copyright holder notifies you of the violation by some reasonable means, this is the first time you have received notice of violation of this License (for any work) from that copyright holder, and you cure the violation prior to 30 days after your receipt of the notice.

Termination of your rights under this section does not terminate the licenses of parties who have received copies or rights from you under this License. If your

rights have been terminated and not permanently reinstated, you do not qualify to receive new licenses for the same material under section 10.

#### 9. Acceptance Not Required for Having Copies.

You are not required to accept this License in order to receive or run a copy of the Program. Ancillary propagation of a covered work occurring solely as a consequence of using peer-to-peer transmission to receive a copy likewise does not require acceptance. However, nothing other than this License grants you permission to propagate or modify any covered work. These actions infringe copyright if you do not accept this License. Therefore, by modifying or propagating a covered work, you indicate your acceptance of this License to do so.

#### 10. Automatic Licensing of Downstream Recipients.

Each time you convey a covered work, the recipient automatically receives a license from the original licensors, to run, modify and propagate that work, subject to this License. You are not responsible for enforcing compliance by third parties with this License.

An "entity transaction" is a transaction transferring control of an organization, or substantially all assets of one, or subdividing an organization, or merging organizations. If propagation of a covered work results from an entity transaction, each party to that transaction who receives a copy of the work also receives whatever licenses to the work the party's predecessor in interest had or could give under the previous paragraph, plus a right to possession of the Corresponding Source of the work from the predecessor in interest, if the predecessor has it or can get it with reasonable efforts.

You may not impose any further restrictions on the exercise of the rights granted or affirmed under this License. For example, you may not impose a license fee, royalty, or other charge for exercise of rights granted under this License, and you may not initiate litigation (including a cross-claim or counterclaim in a lawsuit) alleging that any patent claim is infringed by making, using, selling, offering for sale, or importing the Program or any portion of it.

#### 11. Patents.

A "contributor" is a copyright holder who authorizes use under this License of the Program or a work on which the Program is based. The work thus licensed is called the contributor's "contributor version".

A contributor's "essential patent claims" are all patent claims owned or controlled by the contributor, whether already acquired or hereafter acquired, that would be infringed by some manner, permitted by this License, of making, using, or selling its contributor version, but do not include claims that would be infringed only as a consequence of further modification of the contributor version. For purposes of this definition, "control" includes the right to grant patent sublicenses in a manner consistent with the requirements of this License.

Each contributor grants you a non-exclusive, worldwide, royalty-free patent license under the contributor's essential patent claims, to make, use, sell, offer for sale, import and otherwise run, modify and propagate the contents of its contributor version.

In the following three paragraphs, a "patent license" is any express agreement or commitment, however denominated, not to enforce a patent (such as an express

permission to practice a patent or covenant not to sue for patent infringement). To "grant" such a patent license to a party means to make such an agreement or commitment not to enforce a patent against the party.

If you convey a covered work, knowingly relying on a patent license, and the Corresponding Source of the work is not available for anyone to copy, free of charge and under the terms of this License, through a publicly available network server or other readily accessible means, then you must either (1) cause the Corresponding Source to be so available, or (2) arrange to deprive yourself of the benefit of the patent license for this particular work, or (3) arrange, in a manner consistent with the requirements of this License, to extend the patent license to downstream recipients. "Knowingly relying" means you have actual knowledge that, but for the patent license, your conveying the covered work in a country, or your recipient's use of the covered work in a country, would infringe one or more identifiable patents in that country that you have reason to believe are valid.

If, pursuant to or in connection with a single transaction or arrangement, you convey, or propagate by procuring conveyance of, a covered work, and grant a patent license to some of the parties receiving the covered work authorizing them to use, propagate, modify or convey a specific copy of the covered work, then the patent license you grant is automatically extended to all recipients of the covered work and works based on it.

A patent license is "discriminatory" if it does not include within the scope of its coverage, prohibits the exercise of, or is conditioned on the non-exercise of one or more of the rights that are specifically granted under this License. You may not convey a covered work if you are a party to an arrangement with a third party that is in the business of distributing software, under which you make payment to the third party based on the extent of your activity of conveying the work, and under which the third party grants, to any of the parties who would receive the covered work from you, a discriminatory patent license (a) in connection with copies of the covered work conveyed by you (or copies made from those copies), or (b) primarily for and in connection with specific products or compilations that contain the covered work, unless you entered into that arrangement, or that patent license was granted, prior to 28 March 2007.

Nothing in this License shall be construed as excluding or limiting any implied license or other defenses to infringement that may otherwise be available to you under applicable patent law.

## 12. No Surrender of Others' Freedom.

If conditions are imposed on you (whether by court order, agreement or otherwise) that contradict the conditions of this License, they do not excuse you from the conditions of this License. If you cannot convey a covered work so as to satisfy simultaneously your obligations under this License and any other pertinent obligations, then as a consequence you may not convey it at all. For example, if you agree to terms that obligate you to collect a royalty for further conveying from those to whom you convey the Program, the only way you could satisfy both those terms and this License would be to refrain entirely from conveying the Program.

## 13. Use with the GNU Affero General Public License.

Notwithstanding any other provision of this License, you have permission to link or combine any covered work with a work licensed under version 3 of the GNU Affero General Public License into a single combined work, and to convey the resulting work. The terms of this License will continue to apply to the part which



is the covered work, but the special requirements of the GNU Affero General Public License, section 13, concerning interaction through a network will apply to the combination as such.

#### 14. Revised Versions of this License.

The Free Software Foundation may publish revised and/or new versions of the GNU General Public License from time to time. Such new versions will be similar in spirit to the present version, but may differ in detail to address new problems or concerns.

Each version is given a distinguishing version number. If the Program specifies that a certain numbered version of the GNU General Public License "or any later version" applies to it, you have the option of following the terms and conditions either of that numbered version or of any later version published by the Free Software Foundation. If the Program does not specify a version number of the GNU General Public License, you may choose any version ever published by the Free Software Foundation.

If the Program specifies that a proxy can decide which future versions of the GNU General Public License can be used, that proxy's public statement of acceptance of a version permanently authorizes you to choose that version for the Program.

Later license versions may give you additional or different permissions. However, no additional obligations are imposed on any author or copyright holder as a result of your choosing to follow a later version.

#### 15. Disclaimer of Warranty.

THERE IS NO WARRANTY FOR THE PROGRAM, TO THE EXTENT PERMITTED BY APPLICABLE LAW. EXCEPT WHEN OTHERWISE STATED IN WRITING THE COPYRIGHT HOLDERS AND/OR OTHER PARTIES PROVIDE THE PROGRAM "AS IS" WITHOUT WARRANTY OF ANY KIND, EITHER EXPRESSED OR IMPLIED, INCLUDING, BUT NOT LIMITED TO, THE IMPLIED WARRANTIES OF MERCHANTABILITY AND FITNESS FOR A PARTICULAR PURPOSE. THE ENTIRE RISK AS TO THE QUALITY AND PERFORMANCE OF THE PROGRAM IS WITH YOU. SHOULD THE PROGRAM PROVE DEFECTIVE, YOU ASSUME THE COST OF ALL NECESSARY SERVICING, REPAIR OR CORRECTION.

#### 16. Limitation of Liability.

IN NO EVENT UNLESS REQUIRED BY APPLICABLE LAW OR AGREED TO IN WRITING WILL ANY COPYRIGHT HOLDER, OR ANY OTHER PARTY WHO MODIFIES AND/OR CONVEYS THE PROGRAM AS PERMITTED ABOVE, BE LIABLE TO YOU FOR DAMAGES, INCLUDING ANY GENERAL, SPECIAL, INCIDENTAL OR CONSEQUENTIAL DAMAGES ARISING OUT OF THE USE OR INABILITY TO USE THE PROGRAM (INCLUDING BUT NOT LIMITED TO LOSS OF DATA OR DATA BEING RENDERED INACCURATE OR LOSSES SUSTAINED BY YOU OR THIRD PARTIES OR A FAILURE OF THE PROGRAM TO OPERATE WITH ANY OTHER PROGRAMS), EVEN IF SUCH HOLDER OR OTHER PARTY HAS BEEN ADVISED OF THE POSSIBILITY OF SUCH DAMAGES.

#### 17. Interpretation of Sections 15 and 16.

If the disclaimer of warranty and limitation of liability provided above cannot be given local legal effect according to their terms, reviewing courts shall apply local law that most closely approximates an absolute waiver of all civil liability in connection with the Program, unless a warranty or assumption of liability

accompanies a copy of the Program in return for a fee.

## END OF TERMS AND CONDITIONS

### How to Apply These Terms to Your New Programs

If you develop a new program, and you want it to be of the greatest possible use to the public, the best way to achieve this is to make it free software which everyone can redistribute and change under these terms.

To do so, attach the following notices to the program. It is safest to attach them to the start of each source file to most effectively state the exclusion of warranty; and each file should have at least the "copyright" line and a pointer to where the full notice is found.

<one line to give the program's name and a brief idea of what it does.>  
Copyright (C) <year> <name of author>

This program is free software: you can redistribute it and/or modify it under the terms of the GNU General Public License as published by the Free Software Foundation, either version 3 of the License, or (at your option) any later version.

This program is distributed in the hope that it will be useful, but WITHOUT ANY WARRANTY; without even the implied warranty of MERCHANTABILITY or FITNESS FOR A PARTICULAR PURPOSE. See the GNU General Public License for more details.

You should have received a copy of the GNU General Public License along with this program. If not, see <<http://www.gnu.org/licenses/>>.

Also add information on how to contact you by electronic and paper mail.

If the program does terminal interaction, make it output a short notice like this when it starts in an interactive mode:

```
<program> Copyright (C) <year> <name of author>  
This program comes with ABSOLUTELY NO WARRANTY; for details type `show w'.  
This is free software, and you are welcome to redistribute it under certain  
conditions; type `show c' for details.
```

The hypothetical commands `show w' and `show c' should show the appropriate parts of the General Public License. Of course, your program's commands might be different; for a GUI interface, you would use an "about box".

You should also get your employer (if you work as a programmer) or school, if any, to sign a "copyright disclaimer" for the program, if necessary. For more information on this, and how to apply and follow the GNU GPL, see <<http://www.gnu.org/licenses/>>.

The GNU General Public License does not permit incorporating your program into proprietary programs. If your program is a subroutine library, you may consider it more useful to permit linking proprietary applications with the library. If this is what you want to do, use the GNU Lesser General Public License instead of this License. But first, please read <<http://www.gnu.org/philosophy/why-not-lgpl.html>>.



## □ libpng

GNU GENERAL PUBLIC LICENSE  
Version 3, 29 June 2007

Copyright (C) 2007 Free Software Foundation, Inc. <<http://fsf.org/>>  
Everyone is permitted to copy and distribute verbatim copies of this license document, but changing it is not allowed.

Preamble

The GNU General Public License is a free, copyleft license for software and other kinds of works.

The licenses for most software and other practical works are designed to take away your freedom to share and change the works. By contrast, the GNU General Public License is intended to guarantee your freedom to share and change all versions of a program—to make sure it remains free software for all its users. We, the Free Software Foundation, use the GNU General Public License for most of our software; it applies also to any other work released this way by its authors. You can apply it to your programs, too.

When we speak of free software, we are referring to freedom, not price. Our General Public Licenses are designed to make sure that you have the freedom to distribute copies of free software (and charge for them if you wish), that you receive source code or can get it if you want it, that you can change the software or use pieces of it in new free programs, and that you know you can do these things.

To protect your rights, we need to prevent others from denying you these rights or asking you to surrender the rights. Therefore, you have certain responsibilities if you distribute copies of the software, or if you modify it: responsibilities to respect the freedom of others.

For example, if you distribute copies of such a program, whether gratis or for a fee, you must pass on to the recipients the same freedoms that you received. You must make sure that they, too, receive or can get the source code. And you must show them these terms so they know their rights.

Developers that use the GNU GPL protect your rights with two steps: (1) assert copyright on the software, and (2) offer you this License giving you legal permission to copy, distribute and/or modify it.

For the developers' and authors' protection, the GPL clearly explains that there is no warranty for this free software. For both users' and authors' sake, the GPL requires that modified versions be marked as changed, so that their problems will not be attributed erroneously to authors of previous versions.

Some devices are designed to deny users access to install or run modified versions of the software inside them, although the manufacturer can do so. This is fundamentally incompatible with the aim of protecting users' freedom to change the software. The systematic pattern of such abuse occurs in the area of products for individuals to use, which is precisely where it is most unacceptable. Therefore, we have designed this version of the GPL to prohibit the practice for those products. If such problems arise substantially in other domains, we stand ready to extend this provision to those domains in future versions of the GPL, as needed to protect the freedom of users.

Finally, every program is threatened constantly by software patents. States

should not allow patents to restrict development and use of software on general-purpose computers, but in those that do, we wish to avoid the special danger that patents applied to a free program could make it effectively proprietary. To prevent this, the GPL assures that patents cannot be used to render the program non-free.

The precise terms and conditions for copying, distribution and modification follow.

## TERMS AND CONDITIONS

### 0. Definitions.

"This License" refers to version 3 of the GNU General Public License.

"Copyright" also means copyright-like laws that apply to other kinds of works, such as semiconductor masks.

"The Program" refers to any copyrightable work licensed under this License. Each licensee is addressed as "you". "Licensees" and "recipients" may be individuals or organizations.

To "modify" a work means to copy from or adapt all or part of the work in a fashion requiring copyright permission, other than the making of an exact copy. The resulting work is called a "modified version" of the earlier work or a work "based on" the earlier work.

A "covered work" means either the unmodified Program or a work based on the Program.

To "propagate" a work means to do anything with it that, without permission, would make you directly or secondarily liable for infringement under applicable copyright law, except executing it on a computer or modifying a private copy. Propagation includes copying, distribution (with or without modification), making available to the public, and in some countries other activities as well.

To "convey" a work means any kind of propagation that enables other parties to make or receive copies. Mere interaction with a user through a computer network, with no transfer of a copy, is not conveying.

An interactive user interface displays "Appropriate Legal Notices" to the extent that it includes a convenient and prominently visible feature that (1) displays an appropriate copyright notice, and (2) tells the user that there is no warranty for the work (except to the extent that warranties are provided), that licensees may convey the work under this License, and how to view a copy of this License. If the interface presents a list of user commands or options, such as a menu, a prominent item in the list meets this criterion.

### 1. Source Code.

The "source code" for a work means the preferred form of the work for making modifications to it. "Object code" means any non-source form of a work.

A "Standard Interface" means an interface that either is an official standard defined by a recognized standards body, or, in the case of interfaces specified for a particular programming language, one that is widely used among developers working in that language.

The "System Libraries" of an executable work include anything, other than the

work as a whole, that (a) is included in the normal form of packaging a Major Component, but which is not part of that Major Component, and (b) serves only to enable use of the work with that Major Component, or to implement a Standard Interface for which an implementation is available to the public in source code form. A "Major Component", in this context, means a major essential component (kernel, window system, and so on) of the specific operating system (if any) on which the executable work runs, or a compiler used to produce the work, or an object code interpreter used to run it.

The "Corresponding Source" for a work in object code form means all the source code needed to generate, install, and (for an executable work) run the object code and to modify the work, including scripts to control those activities. However, it does not include the work's System Libraries, or general-purpose tools or generally available free programs which are used unmodified in performing those activities but which are not part of the work. For example, Corresponding Source includes interface definition files associated with source files for the work, and the source code for shared libraries and dynamically linked subprograms that the work is specifically designed to require, such as by intimate data communication or control flow between those subprograms and other parts of the work.

The Corresponding Source need not include anything that users can regenerate automatically from other parts of the Corresponding Source.

The Corresponding Source for a work in source code form is that same work.

## 2. Basic Permissions.

All rights granted under this License are granted for the term of copyright on the Program, and are irrevocable provided the stated conditions are met. This License explicitly affirms your unlimited permission to run the unmodified Program. The output from running a covered work is covered by this License only if the output, given its content, constitutes a covered work. This License acknowledges your rights of fair use or other equivalent, as provided by copyright law.

You may make, run and propagate covered works that you do not convey, without conditions so long as your license otherwise remains in force. You may convey covered works to others for the sole purpose of having them make modifications exclusively for you, or provide you with facilities for running those works, provided that you comply with the terms of this License in conveying all material for which you do not control copyright. Those thus making or running the covered works for you must do so exclusively on your behalf, under your direction and control, on terms that prohibit them from making any copies of your copyrighted material outside their relationship with you.

Conveying under any other circumstances is permitted solely under the conditions stated below. Sublicensing is not allowed; section 10 makes it unnecessary.

## 3. Protecting Users' Legal Rights From Anti-Circumvention Law.

No covered work shall be deemed part of an effective technological measure under any applicable law fulfilling obligations under article 11 of the WIPO copyright treaty adopted on 20 December 1996, or similar laws prohibiting or restricting circumvention of such measures.

When you convey a covered work, you waive any legal power to forbid circumvention of technological measures to the extent such circumvention is effected by exercising rights under this License with respect to the covered work, and you disclaim any intention to limit operation or modification of the work as a

means of enforcing, against the work's users, your or third parties' legal rights to forbid circumvention of technological measures.

#### 4. Conveying Verbatim Copies.

You may convey verbatim copies of the Program's source code as you receive it, in any medium, provided that you conspicuously and appropriately publish on each copy an appropriate copyright notice; keep intact all notices stating that this License and any non-permissive terms added in accord with section 7 apply to the code; keep intact all notices of the absence of any warranty; and give all recipients a copy of this License along with the Program.

You may charge any price or no price for each copy that you convey, and you may offer support or warranty protection for a fee.

#### 5. Conveying Modified Source Versions.

You may convey a work based on the Program, or the modifications to produce it from the Program, in the form of source code under the terms of section 4, provided that you also meet all of these conditions:

a) The work must carry prominent notices stating that you modified it, and giving a relevant date.

b) The work must carry prominent notices stating that it is released under this License and any conditions added under section 7. This requirement modifies the requirement in section 4 to "keep intact all notices".

c) You must license the entire work, as a whole, under this License to anyone who comes into possession of a copy. This License will therefore apply, along with any applicable section 7 additional terms, to the whole of the work, and all its parts, regardless of how they are packaged. This License gives no permission to license the work in any other way, but it does not invalidate such permission if you have separately received it.

d) If the work has interactive user interfaces, each must display Appropriate Legal Notices; however, if the Program has interactive interfaces that do not display Appropriate Legal Notices, your work need not make them do so.

A compilation of a covered work with other separate and independent works, which are not by their nature extensions of the covered work, and which are not combined with it such as to form a larger program, in or on a volume of a storage or distribution medium, is called an "aggregate" if the compilation and its resulting copyright are not used to limit the access or legal rights of the compilation's users beyond what the individual works permit. Inclusion of a covered work in an aggregate does not cause this License to apply to the other parts of the aggregate.

#### 6. Conveying Non-Source Forms.

You may convey a covered work in object code form under the terms of sections 4 and 5, provided that you also convey the machine-readable Corresponding Source under the terms of this License, in one of these ways:

a) Convey the object code in, or embodied in, a physical product (including a physical distribution medium), accompanied by the Corresponding Source fixed on a durable physical medium customarily used for software interchange.

b) Convey the object code in, or embodied in, a physical product (including a physical distribution medium), accompanied by a written offer, valid for at least three years and valid for as long as you offer spare parts or customer support for that product model, to give anyone who possesses the object code either (1) a copy of the Corresponding Source for all the software in the product that is covered by this License, on a durable physical medium customarily used for software interchange, for a price no more than your reasonable cost of physically performing this conveying of source, or (2) access to copy the Corresponding Source from a network server at no charge.

c) Convey individual copies of the object code with a copy of the written offer to provide the Corresponding Source. This alternative is allowed only occasionally and noncommercially, and only if you received the object code with such an offer, in accord with subsection 6b.

d) Convey the object code by offering access from a designated place (gratis or for a charge), and offer equivalent access to the Corresponding Source in the same way through the same place at no further charge. You need not require recipients to copy the Corresponding Source along with the object code. If the place to copy the object code is a network server, the Corresponding Source may be on a different server (operated by you or a third party) that supports equivalent copying facilities, provided you maintain clear directions next to the object code saying where to find the Corresponding Source. Regardless of what server hosts the Corresponding Source, you remain obligated to ensure that it is available for as long as needed to satisfy these requirements.

e) Convey the object code using peer-to-peer transmission, provided you inform other peers where the object code and Corresponding Source of the work are being offered to the general public at no charge under subsection 6d.

A separable portion of the object code, whose source code is excluded from the Corresponding Source as a System Library, need not be included in conveying the object code work.

A "User Product" is either (1) a "consumer product", which means any tangible personal property which is normally used for personal, family, or household purposes, or (2) anything designed or sold for incorporation into a dwelling. In determining whether a product is a consumer product, doubtful cases shall be resolved in favor of coverage. For a particular product received by a particular user, "normally used" refers to a typical or common use of that class of product, regardless of the status of the particular user or of the way in which the particular user actually uses, or expects or is expected to use, the product. A product is a consumer product regardless of whether the product has substantial commercial, industrial or non-consumer uses, unless such uses represent the only significant mode of use of the product.

"Installation Information" for a User Product means any methods, procedures, authorization keys, or other information required to install and execute modified versions of a covered work in that User Product from a modified version of its Corresponding Source. The information must suffice to ensure that the continued functioning of the modified object code is in no case prevented or interfered with solely because modification has been made.

If you convey an object code work under this section in, or with, or specifically for use in, a User Product, and the conveying occurs as part of a transaction in which the right of possession and use of the User Product is transferred to the recipient in perpetuity or for a fixed term (regardless of how the transaction is characterized), the Corresponding Source conveyed under this section must be

accompanied by the Installation Information. But this requirement does not apply if neither you nor any third party retains the ability to install modified object code on the User Product (for example, the work has been installed in ROM).

The requirement to provide Installation Information does not include a requirement to continue to provide support service, warranty, or updates for a work that has been modified or installed by the recipient, or for the User Product in which it has been modified or installed. Access to a network may be denied when the modification itself materially and adversely affects the operation of the network or violates the rules and protocols for communication across the network.

Corresponding Source conveyed, and Installation Information provided, in accord with this section must be in a format that is publicly documented (and with an implementation available to the public in source code form), and must require no special password or key for unpacking, reading or copying.

## 7. Additional Terms.

"Additional permissions" are terms that supplement the terms of this License by making exceptions from one or more of its conditions. Additional permissions that are applicable to the entire Program shall be treated as though they were included in this License, to the extent that they are valid under applicable law. If additional permissions apply only to part of the Program, that part may be used separately under those permissions, but the entire Program remains governed by this License without regard to the additional permissions.

When you convey a copy of a covered work, you may at your option remove any additional permissions from that copy, or from any part of it. (Additional permissions may be written to require their own removal in certain cases when you modify the work.) You may place additional permissions on material, added by you to a covered work, for which you have or can give appropriate copyright permission.

Notwithstanding any other provision of this License, for material you add to a covered work, you may (if authorized by the copyright holders of that material) supplement the terms of this License with terms:

- a) Disclaiming warranty or limiting liability differently from the terms of sections 15 and 16 of this License; or
- b) Requiring preservation of specified reasonable legal notices or author attributions in that material or in the Appropriate Legal Notices displayed by works containing it; or
- c) Prohibiting misrepresentation of the origin of that material, or requiring that modified versions of such material be marked in reasonable ways as different from the original version; or
- d) Limiting the use for publicity purposes of names of licensors or authors of the material; or
- e) Declining to grant rights under trademark law for use of some trade names, trademarks, or service marks; or
- f) Requiring indemnification of licensors and authors of that material by anyone who conveys the material (or modified versions of it) with contractual assumptions of liability to the recipient, for any liability that these contractual assumptions directly impose on those licensors and authors.

All other non-permissive additional terms are considered "further restrictions" within the meaning of section 10. If the Program as you received it, or any part of it, contains a notice stating that it is governed by this License along with a term that is a further restriction, you may remove that term. If a license document contains a further restriction but permits relicensing or conveying under this License, you may add to a covered work material governed by the terms of that license document, provided that the further restriction does not survive such relicensing or conveying.

If you add terms to a covered work in accord with this section, you must place, in the relevant source files, a statement of the additional terms that apply to those files, or a notice indicating where to find the applicable terms.

Additional terms, permissive or non-permissive, may be stated in the form of a separately written license, or stated as exceptions; the above requirements apply either way.

#### 8. Termination.

You may not propagate or modify a covered work except as expressly provided under this License. Any attempt otherwise to propagate or modify it is void, and will automatically terminate your rights under this License (including any patent licenses granted under the third paragraph of section 11).

However, if you cease all violation of this License, then your license from a particular copyright holder is reinstated (a) provisionally, unless and until the copyright holder explicitly and finally terminates your license, and (b) permanently, if the copyright holder fails to notify you of the violation by some reasonable means prior to 60 days after the cessation.

Moreover, your license from a particular copyright holder is reinstated permanently if the copyright holder notifies you of the violation by some reasonable means, this is the first time you have received notice of violation of this License (for any work) from that copyright holder, and you cure the violation prior to 30 days after your receipt of the notice.

Termination of your rights under this section does not terminate the licenses of parties who have received copies or rights from you under this License. If your rights have been terminated and not permanently reinstated, you do not qualify to receive new licenses for the same material under section 10.

#### 9. Acceptance Not Required for Having Copies.

You are not required to accept this License in order to receive or run a copy of the Program. Ancillary propagation of a covered work occurring solely as a consequence of using peer-to-peer transmission to receive a copy likewise does not require acceptance. However, nothing other than this License grants you permission to propagate or modify any covered work. These actions infringe copyright if you do not accept this License. Therefore, by modifying or propagating a covered work, you indicate your acceptance of this License to do so.

#### 10. Automatic Licensing of Downstream Recipients.

Each time you convey a covered work, the recipient automatically receives a license from the original licensors, to run, modify and propagate that work, subject to this License. You are not responsible for enforcing compliance by third parties



with this License.

An "entity transaction" is a transaction transferring control of an organization, or substantially all assets of one, or subdividing an organization, or merging organizations. If propagation of a covered work results from an entity transaction, each party to that transaction who receives a copy of the work also receives whatever licenses to the work the party's predecessor in interest had or could give under the previous paragraph, plus a right to possession of the Corresponding Source of the work from the predecessor in interest, if the predecessor has it or can get it with reasonable efforts.

You may not impose any further restrictions on the exercise of the rights granted or affirmed under this License. For example, you may not impose a license fee, royalty, or other charge for exercise of rights granted under this License, and you may not initiate litigation (including a cross-claim or counterclaim in a lawsuit) alleging that any patent claim is infringed by making, using, selling, offering for sale, or importing the Program or any portion of it.

## 11. Patents.

A "contributor" is a copyright holder who authorizes use under this License of the Program or a work on which the Program is based. The work thus licensed is called the contributor's "contributor version".

A contributor's "essential patent claims" are all patent claims owned or controlled by the contributor, whether already acquired or hereafter acquired, that would be infringed by some manner, permitted by this License, of making, using, or selling its contributor version, but do not include claims that would be infringed only as a consequence of further modification of the contributor version. For purposes of this definition, "control" includes the right to grant patent sublicenses in a manner consistent with the requirements of this License.

Each contributor grants you a non-exclusive, worldwide, royalty-free patent license under the contributor's essential patent claims, to make, use, sell, offer for sale, import and otherwise run, modify and propagate the contents of its contributor version.

In the following three paragraphs, a "patent license" is any express agreement or commitment, however denominated, not to enforce a patent (such as an express permission to practice a patent or covenant not to sue for patent infringement). To "grant" such a patent license to a party means to make such an agreement or commitment not to enforce a patent against the party.

If you convey a covered work, knowingly relying on a patent license, and the Corresponding Source of the work is not available for anyone to copy, free of charge and under the terms of this License, through a publicly available network server or other readily accessible means, then you must either (1) cause the Corresponding Source to be so available, or (2) arrange to deprive yourself of the benefit of the patent license for this particular work, or (3) arrange, in a manner consistent with the requirements of this License, to extend the patent license to downstream recipients. "Knowingly relying" means you have actual knowledge that, but for the patent license, your conveying the covered work in a country, or your recipient's use of the covered work in a country, would infringe one or more identifiable patents in that country that you have reason to believe are valid.

If, pursuant to or in connection with a single transaction or arrangement, you convey, or propagate by procuring conveyance of, a covered work, and grant a patent license to some of the parties receiving the covered work authorizing them



to use, propagate, modify or convey a specific copy of the covered work, then the patent license you grant is automatically extended to all recipients of the covered work and works based on it.

A patent license is "discriminatory" if it does not include within the scope of its coverage, prohibits the exercise of, or is conditioned on the non-exercise of one or more of the rights that are specifically granted under this License. You may not convey a covered work if you are a party to an arrangement with a third party that is in the business of distributing software, under which you make payment to the third party based on the extent of your activity of conveying the work, and under which the third party grants, to any of the parties who would receive the covered work from you, a discriminatory patent license (a) in connection with copies of the covered work conveyed by you (or copies made from those copies), or (b) primarily for and in connection with specific products or compilations that contain the covered work, unless you entered into that arrangement, or that patent license was granted, prior to 28 March 2007.

Nothing in this License shall be construed as excluding or limiting any implied license or other defenses to infringement that may otherwise be available to you under applicable patent law.

#### 12. No Surrender of Others' Freedom.

If conditions are imposed on you (whether by court order, agreement or otherwise) that contradict the conditions of this License, they do not excuse you from the conditions of this License. If you cannot convey a covered work so as to satisfy simultaneously your obligations under this License and any other pertinent obligations, then as a consequence you may not convey it at all. For example, if you agree to terms that obligate you to collect a royalty for further conveying from those to whom you convey the Program, the only way you could satisfy both those terms and this License would be to refrain entirely from conveying the Program.

#### 13. Use with the GNU Affero General Public License.

Notwithstanding any other provision of this License, you have permission to link or combine any covered work with a work licensed under version 3 of the GNU Affero General Public License into a single combined work, and to convey the resulting work. The terms of this License will continue to apply to the part which is the covered work, but the special requirements of the GNU Affero General Public License, section 13, concerning interaction through a network will apply to the combination as such.

#### 14. Revised Versions of this License.

The Free Software Foundation may publish revised and/or new versions of the GNU General Public License from time to time. Such new versions will be similar in spirit to the present version, but may differ in detail to address new problems or concerns.

Each version is given a distinguishing version number. If the Program specifies that a certain numbered version of the GNU General Public License "or any later version" applies to it, you have the option of following the terms and conditions either of that numbered version or of any later version published by the Free Software Foundation. If the Program does not specify a version number of the GNU General Public License, you may choose any version ever published by the Free Software Foundation.

If the Program specifies that a proxy can decide which future versions of the GNU General Public License can be used, that proxy's public statement of acceptance of a version permanently authorizes you to choose that version for the Program.

Later license versions may give you additional or different permissions. However, no additional obligations are imposed on any author or copyright holder as a result of your choosing to follow a later version.

#### 15. Disclaimer of Warranty.

THERE IS NO WARRANTY FOR THE PROGRAM, TO THE EXTENT PERMITTED BY APPLICABLE LAW. EXCEPT WHEN OTHERWISE STATED IN WRITING THE COPYRIGHT HOLDERS AND/OR OTHER PARTIES PROVIDE THE PROGRAM "AS IS" WITHOUT WARRANTY OF ANY KIND, EITHER EXPRESSED OR IMPLIED, INCLUDING, BUT NOT LIMITED TO, THE IMPLIED WARRANTIES OF MERCHANTABILITY AND FITNESS FOR A PARTICULAR PURPOSE. THE ENTIRE RISK AS TO THE QUALITY AND PERFORMANCE OF THE PROGRAM IS WITH YOU. SHOULD THE PROGRAM PROVE DEFECTIVE, YOU ASSUME THE COST OF ALL NECESSARY SERVICING, REPAIR OR CORRECTION.

#### 16. Limitation of Liability.

IN NO EVENT UNLESS REQUIRED BY APPLICABLE LAW OR AGREED TO IN WRITING WILL ANY COPYRIGHT HOLDER, OR ANY OTHER PARTY WHO MODIFIES AND/OR CONVEYS THE PROGRAM AS PERMITTED ABOVE, BE LIABLE TO YOU FOR DAMAGES, INCLUDING ANY GENERAL, SPECIAL, INCIDENTAL OR CONSEQUENTIAL DAMAGES ARISING OUT OF THE USE OR INABILITY TO USE THE PROGRAM (INCLUDING BUT NOT LIMITED TO LOSS OF DATA OR DATA BEING RENDERED INACCURATE OR LOSSES SUSTAINED BY YOU OR THIRD PARTIES OR A FAILURE OF THE PROGRAM TO OPERATE WITH ANY OTHER PROGRAMS), EVEN IF SUCH HOLDER OR OTHER PARTY HAS BEEN ADVISED OF THE POSSIBILITY OF SUCH DAMAGES.

#### 17. Interpretation of Sections 15 and 16.

If the disclaimer of warranty and limitation of liability provided above cannot be given local legal effect according to their terms, reviewing courts shall apply local law that most closely approximates an absolute waiver of all civil liability in connection with the Program, unless a warranty or assumption of liability accompanies a copy of the Program in return for a fee.

### END OF TERMS AND CONDITIONS

#### How to Apply These Terms to Your New Programs

If you develop a new program, and you want it to be of the greatest possible use to the public, the best way to achieve this is to make it free software which everyone can redistribute and change under these terms.

To do so, attach the following notices to the program. It is safest to attach them to the start of each source file to most effectively state the exclusion of warranty; and each file should have at least the "copyright" line and a pointer to where the full notice is found.

```
<one line to give the program's name and a brief idea of what it does.>  
Copyright (C) <year> <name of author>
```

This program is free software: you can redistribute it and/or modify it under

the terms of the GNU General Public License as published by the Free Software Foundation, either version 3 of the License, or (at your option) any later version.

This program is distributed in the hope that it will be useful, but WITHOUT ANY WARRANTY; without even the implied warranty of MERCHANTABILITY or FITNESS FOR A PARTICULAR PURPOSE. See the GNU General Public License for more details.

You should have received a copy of the GNU General Public License along with this program. If not, see <http://www.gnu.org/licenses/>.

Also add information on how to contact you by electronic and paper mail.

If the program does terminal interaction, make it output a short notice like this when it starts in an interactive mode:

```
<program> Copyright (C) <year> <name of author>
This program comes with ABSOLUTELY NO WARRANTY; for details type `show
w'.
This is free software, and you are welcome to redistribute it under certain
conditions; type `show c' for details.
```

The hypothetical commands `show w' and `show c' should show the appropriate parts of the General Public License. Of course, your program's commands might be different; for a GUI interface, you would use an "about box".

You should also get your employer (if you work as a programmer) or school, if any, to sign a "copyright disclaimer" for the program, if necessary. For more information on this, and how to apply and follow the GNU GPL, see <http://www.gnu.org/licenses/>.

The GNU General Public License does not permit incorporating your program into proprietary programs. If your program is a subroutine library, you may consider it more useful to permit linking proprietary applications with the library. If this is what you want to do, use the GNU Lesser General Public License instead of this License. But first, please read <http://www.gnu.org/philosophy/why-not-lgpl.html>.

## ❑ libtiff

GNU GENERAL PUBLIC LICENSE  
Version 3, 29 June 2007

Copyright (C) 2007 Free Software Foundation, Inc. <http://fsf.org/>  
Everyone is permitted to copy and distribute verbatim copies of this license document, but changing it is not allowed.

Preamble

The GNU General Public License is a free, copyleft license for software and other kinds of works.

The licenses for most software and other practical works are designed to take away your freedom to share and change the works. By contrast, the GNU General Public License is intended to guarantee your freedom to share and change all versions of a program--to make sure it remains free software for all its users. We, the Free Software Foundation, use the GNU General Public License for most of our software; it applies also to any other work released this way by its authors. You can apply it to your programs, too.

When we speak of free software, we are referring to freedom, not price. Our General Public Licenses are designed to make sure that you have the freedom to distribute copies of free software (and charge for them if you wish), that you receive source code or can get it if you want it, that you can change the software or use pieces of it in new free programs, and that you know you can do these things.

To protect your rights, we need to prevent others from denying you these rights or asking you to surrender the rights. Therefore, you have certain responsibilities if you distribute copies of the software, or if you modify it: responsibilities to respect the freedom of others.

For example, if you distribute copies of such a program, whether gratis or for a fee, you must pass on to the recipients the same freedoms that you received. You must make sure that they, too, receive or can get the source code. And you must show them these terms so they know their rights.

Developers that use the GNU GPL protect your rights with two steps: (1) assert copyright on the software, and (2) offer you this License giving you legal permission to copy, distribute and/or modify it.

For the developers' and authors' protection, the GPL clearly explains that there is no warranty for this free software. For both users' and authors' sake, the GPL requires that modified versions be marked as changed, so that their problems will not be attributed erroneously to authors of previous versions.

Some devices are designed to deny users access to install or run modified versions of the software inside them, although the manufacturer can do so. This is fundamentally incompatible with the aim of protecting users' freedom to change the software. The systematic pattern of such abuse occurs in the area of products for individuals to use, which is precisely where it is most unacceptable. Therefore, we have designed this version of the GPL to prohibit the practice for those products. If such problems arise substantially in other domains, we stand ready to extend this provision to those domains in future versions of the GPL, as needed to protect the freedom of users.

Finally, every program is threatened constantly by software patents. States should not allow patents to restrict development and use of software on general-purpose computers, but in those that do, we wish to avoid the special danger that patents applied to a free program could make it effectively proprietary. To prevent this, the GPL assures that patents cannot be used to render the program non-free.

The precise terms and conditions for copying, distribution and modification follow.

## TERMS AND CONDITIONS

### 0. Definitions.

"This License" refers to version 3 of the GNU General Public License.

"Copyright" also means copyright-like laws that apply to other kinds of works, such as semiconductor masks.

"The Program" refers to any copyrightable work licensed under this License. Each licensee is addressed as "you". "Licensees" and "recipients" may be individuals or organizations.

To "modify" a work means to copy from or adapt all or part of the work in a fashion requiring copyright permission, other than the making of an exact copy. The resulting work is called a "modified version" of the earlier work or a work "based on" the earlier work.

A "covered work" means either the unmodified Program or a work based on the Program.

To "propagate" a work means to do anything with it that, without permission, would make you directly or secondarily liable for infringement under applicable copyright law, except executing it on a computer or modifying a private copy. Propagation includes copying, distribution (with or without modification), making available to the public, and in some countries other activities as well.

To "convey" a work means any kind of propagation that enables other parties to make or receive copies. Mere interaction with a user through a computer network, with no transfer of a copy, is not conveying.

An interactive user interface displays "Appropriate Legal Notices" to the extent that it includes a convenient and prominently visible feature that (1) displays an appropriate copyright notice, and (2) tells the user that there is no warranty for the work (except to the extent that warranties are provided), that licensees may convey the work under this License, and how to view a copy of this License. If the interface presents a list of user commands or options, such as a menu, a prominent item in the list meets this criterion.

#### 1. Source Code.

The "source code" for a work means the preferred form of the work for making modifications to it. "Object code" means any non-source form of a work.

A "Standard Interface" means an interface that either is an official standard defined by a recognized standards body, or, in the case of interfaces specified for a particular programming language, one that is widely used among developers working in that language.

The "System Libraries" of an executable work include anything, other than the work as a whole, that (a) is included in the normal form of packaging a Major Component, but which is not part of that Major Component, and (b) serves only to enable use of the work with that Major Component, or to implement a Standard Interface for which an implementation is available to the public in source code form. A "Major Component", in this context, means a major essential component (kernel, window system, and so on) of the specific operating system (if any) on which the executable work runs, or a compiler used to produce the work, or an object code interpreter used to run it.

The "Corresponding Source" for a work in object code form means all the source code needed to generate, install, and (for an executable work) run the object code and to modify the work, including scripts to control those activities. However, it does not include the work's System Libraries, or general-purpose tools or generally available free programs which are used unmodified in performing those activities but which are not part of the work. For example, Corresponding Source includes interface definition files associated with source files for the work, and the source code for shared libraries and dynamically linked subprograms that the work is specifically designed to require, such as by intimate data communication or control flow between those subprograms and other parts of the work.

The Corresponding Source need not include anything that users can regenerate automatically from other parts of the Corresponding Source.

The Corresponding Source for a work in source code form is that same work.

## 2. Basic Permissions.

All rights granted under this License are granted for the term of copyright on the Program, and are irrevocable provided the stated conditions are met. This License explicitly affirms your unlimited permission to run the unmodified Program. The output from running a covered work is covered by this License only if the output, given its content, constitutes a covered work. This License acknowledges your rights of fair use or other equivalent, as provided by copyright law.

You may make, run and propagate covered works that you do not convey, without conditions so long as your license otherwise remains in force. You may convey covered works to others for the sole purpose of having them make modifications exclusively for you, or provide you with facilities for running those works, provided that you comply with the terms of this License in conveying all material for which you do not control copyright. Those thus making or running the covered works for you must do so exclusively on your behalf, under your direction and control, on terms that prohibit them from making any copies of your copyrighted material outside their relationship with you.

Conveying under any other circumstances is permitted solely under the conditions stated below. Sublicensing is not allowed; section 10 makes it unnecessary.

## 3. Protecting Users' Legal Rights From Anti-Circumvention Law.

No covered work shall be deemed part of an effective technological measure under any applicable law fulfilling obligations under article 11 of the WIPO copyright treaty adopted on 20 December 1996, or similar laws prohibiting or restricting circumvention of such measures.

When you convey a covered work, you waive any legal power to forbid circumvention of technological measures to the extent such circumvention is effected by exercising rights under this License with respect to the covered work, and you disclaim any intention to limit operation or modification of the work as a means of enforcing, against the work's users, your or third parties' legal rights to forbid circumvention of technological measures.

## 4. Conveying Verbatim Copies.

You may convey verbatim copies of the Program's source code as you receive it, in any medium, provided that you conspicuously and appropriately publish on each copy an appropriate copyright notice; keep intact all notices stating that this License and any non-permissive terms added in accord with section 7 apply to the code; keep intact all notices of the absence of any warranty; and give all recipients a copy of this License along with the Program.

You may charge any price or no price for each copy that you convey, and you may offer support or warranty protection for a fee.

## 5. Conveying Modified Source Versions.

You may convey a work based on the Program, or the modifications to produce it from the Program, in the form of source code under the terms of section 4, provided that you also meet all of these conditions:

a) The work must carry prominent notices stating that you modified it, and giving a relevant date.

b) The work must carry prominent notices stating that it is released under this License and any conditions added under section 7. This requirement modifies the requirement in section 4 to "keep intact all notices".

c) You must license the entire work, as a whole, under this License to anyone who comes into possession of a copy. This License will therefore apply, along with any applicable section 7 additional terms, to the whole of the work, and all its parts, regardless of how they are packaged. This License gives no permission to license the work in any other way, but it does not invalidate such permission if you have separately received it.

d) If the work has interactive user interfaces, each must display Appropriate Legal Notices; however, if the Program has interactive interfaces that do not display Appropriate Legal Notices, your work need not make them do so.

A compilation of a covered work with other separate and independent works, which are not by their nature extensions of the covered work, and which are not combined with it such as to form a larger program, in or on a volume of a storage or distribution medium, is called an "aggregate" if the compilation and its resulting copyright are not used to limit the access or legal rights of the compilation's users beyond what the individual works permit. Inclusion of a covered work in an aggregate does not cause this License to apply to the other parts of the aggregate.

## 6. Conveying Non-Source Forms.

You may convey a covered work in object code form under the terms of sections 4 and 5, provided that you also convey the machine-readable Corresponding Source under the terms of this License, in one of these ways:

a) Convey the object code in, or embodied in, a physical product (including a physical distribution medium), accompanied by the Corresponding Source fixed on a durable physical medium customarily used for software interchange.

b) Convey the object code in, or embodied in, a physical product (including a physical distribution medium), accompanied by a written offer, valid for at least three years and valid for as long as you offer spare parts or customer support for that product model, to give anyone who possesses the object code either (1) a copy of the Corresponding Source for all the software in the product that is covered by this License, on a durable physical medium customarily used for software interchange, for a price no more than your reasonable cost of physically performing this conveying of source, or (2) access to copy the Corresponding Source from a network server at no charge.

c) Convey individual copies of the object code with a copy of the written offer to provide the Corresponding Source. This alternative is allowed only occasionally and noncommercially, and only if you received the object code with such an offer, in accord with subsection 6b.

d) Convey the object code by offering access from a designated place (gratis or for a charge), and offer equivalent access to the Corresponding Source in the same way through the same place at no further charge. You need not require recipients to copy the Corresponding Source along with the object code. If the place to copy the object code is a network server, the Corresponding Source



may be on a different server (operated by you or a third party) that supports equivalent copying facilities, provided you maintain clear directions next to the object code saying where to find the Corresponding Source. Regardless of what server hosts the Corresponding Source, you remain obligated to ensure that it is available for as long as needed to satisfy these requirements.

e) Convey the object code using peer-to-peer transmission, provided you inform other peers where the object code and Corresponding Source of the work are being offered to the general public at no charge under subsection 6d.

A separable portion of the object code, whose source code is excluded from the Corresponding Source as a System Library, need not be included in conveying the object code work.

A "User Product" is either (1) a "consumer product", which means any tangible personal property which is normally used for personal, family, or household purposes, or (2) anything designed or sold for incorporation into a dwelling. In determining whether a product is a consumer product, doubtful cases shall be resolved in favor of coverage. For a particular product received by a particular user, "normally used" refers to a typical or common use of that class of product, regardless of the status of the particular user or of the way in which the particular user actually uses, or expects or is expected to use, the product. A product is a consumer product regardless of whether the product has substantial commercial, industrial or non-consumer uses, unless such uses represent the only significant mode of use of the product.

"Installation Information" for a User Product means any methods, procedures, authorization keys, or other information required to install and execute modified versions of a covered work in that User Product from a modified version of its Corresponding Source. The information must suffice to ensure that the continued functioning of the modified object code is in no case prevented or interfered with solely because modification has been made.

If you convey an object code work under this section in, or with, or specifically for use in, a User Product, and the conveying occurs as part of a transaction in which the right of possession and use of the User Product is transferred to the recipient in perpetuity or for a fixed term (regardless of how the transaction is characterized), the Corresponding Source conveyed under this section must be accompanied by the Installation Information. But this requirement does not apply if neither you nor any third party retains the ability to install modified object code on the User Product (for example, the work has been installed in ROM).

The requirement to provide Installation Information does not include a requirement to continue to provide support service, warranty, or updates for a work that has been modified or installed by the recipient, or for the User Product in which it has been modified or installed. Access to a network may be denied when the modification itself materially and adversely affects the operation of the network or violates the rules and protocols for communication across the network.

Corresponding Source conveyed, and Installation Information provided, in accord with this section must be in a format that is publicly documented (and with an implementation available to the public in source code form), and must require no special password or key for unpacking, reading or copying.

## 7. Additional Terms.

"Additional permissions" are terms that supplement the terms of this License by making exceptions from one or more of its conditions. Additional permissions



that are applicable to the entire Program shall be treated as though they were included in this License, to the extent that they are valid under applicable law. If additional permissions apply only to part of the Program, that part may be used separately under those permissions, but the entire Program remains governed by this License without regard to the additional permissions.

When you convey a copy of a covered work, you may at your option remove any additional permissions from that copy, or from any part of it. (Additional permissions may be written to require their own removal in certain cases when you modify the work.) You may place additional permissions on material, added by you to a covered work, for which you have or can give appropriate copyright permission.

Notwithstanding any other provision of this License, for material you add to a covered work, you may (if authorized by the copyright holders of that material) supplement the terms of this License with terms:

- a) Disclaiming warranty or limiting liability differently from the terms of sections 15 and 16 of this License; or
- b) Requiring preservation of specified reasonable legal notices or author attributions in that material or in the Appropriate Legal Notices displayed by works containing it; or
- c) Prohibiting misrepresentation of the origin of that material, or requiring that modified versions of such material be marked in reasonable ways as different from the original version; or
- d) Limiting the use for publicity purposes of names of licensors or authors of the material; or
- e) Declining to grant rights under trademark law for use of some trade names, trademarks, or service marks; or
- f) Requiring indemnification of licensors and authors of that material by anyone who conveys the material (or modified versions of it) with contractual assumptions of liability to the recipient, for any liability that these contractual assumptions directly impose on those licensors and authors.

All other non-permissive additional terms are considered "further restrictions" within the meaning of section 10. If the Program as you received it, or any part of it, contains a notice stating that it is governed by this License along with a term that is a further restriction, you may remove that term. If a license document contains a further restriction but permits relicensing or conveying under this License, you may add to a covered work material governed by the terms of that license document, provided that the further restriction does not survive such relicensing or conveying.

If you add terms to a covered work in accord with this section, you must place, in the relevant source files, a statement of the additional terms that apply to those files, or a notice indicating where to find the applicable terms.

Additional terms, permissive or non-permissive, may be stated in the form of a separately written license, or stated as exceptions; the above requirements apply either way.

## 8. Termination.

You may not propagate or modify a covered work except as expressly provided under this License. Any attempt otherwise to propagate or modify it is void, and will automatically terminate your rights under this License (including any patent licenses granted under the third paragraph of section 11).

However, if you cease all violation of this License, then your license from a particular copyright holder is reinstated (a) provisionally, unless and until the copyright holder explicitly and finally terminates your license, and (b) permanently, if the copyright holder fails to notify you of the violation by some reasonable means prior to 60 days after the cessation.

Moreover, your license from a particular copyright holder is reinstated permanently if the copyright holder notifies you of the violation by some reasonable means, this is the first time you have received notice of violation of this License (for any work) from that copyright holder, and you cure the violation prior to 30 days after your receipt of the notice.

Termination of your rights under this section does not terminate the licenses of parties who have received copies or rights from you under this License. If your rights have been terminated and not permanently reinstated, you do not qualify to receive new licenses for the same material under section 10.

#### 9. Acceptance Not Required for Having Copies.

You are not required to accept this License in order to receive or run a copy of the Program. Ancillary propagation of a covered work occurring solely as a consequence of using peer-to-peer transmission to receive a copy likewise does not require acceptance. However, nothing other than this License grants you permission to propagate or modify any covered work. These actions infringe copyright if you do not accept this License. Therefore, by modifying or propagating a covered work, you indicate your acceptance of this License to do so.

#### 10. Automatic Licensing of Downstream Recipients.

Each time you convey a covered work, the recipient automatically receives a license from the original licensors, to run, modify and propagate that work, subject to this License. You are not responsible for enforcing compliance by third parties with this License.

An "entity transaction" is a transaction transferring control of an organization, or substantially all assets of one, or subdividing an organization, or merging organizations. If propagation of a covered work results from an entity transaction, each party to that transaction who receives a copy of the work also receives whatever licenses to the work the party's predecessor in interest had or could give under the previous paragraph, plus a right to possession of the Corresponding Source of the work from the predecessor in interest, if the predecessor has it or can get it with reasonable efforts.

You may not impose any further restrictions on the exercise of the rights granted or affirmed under this License. For example, you may not impose a license fee, royalty, or other charge for exercise of rights granted under this License, and you may not initiate litigation (including a cross-claim or counterclaim in a lawsuit) alleging that any patent claim is infringed by making, using, selling, offering for sale, or importing the Program or any portion of it.

#### 11. Patents.

A "contributor" is a copyright holder who authorizes use under this License of the Program or a work on which the Program is based. The work thus licensed is called the contributor's "contributor version".

A contributor's "essential patent claims" are all patent claims owned or controlled by the contributor, whether already acquired or hereafter acquired, that would be infringed by some manner, permitted by this License, of making, using, or selling its contributor version, but do not include claims that would be infringed only as a consequence of further modification of the contributor version. For purposes of this definition, "control" includes the right to grant patent sublicenses in a manner consistent with the requirements of this License.

Each contributor grants you a non-exclusive, worldwide, royalty-free patent license under the contributor's essential patent claims, to make, use, sell, offer for sale, import and otherwise run, modify and propagate the contents of its contributor version.

In the following three paragraphs, a "patent license" is any express agreement or commitment, however denominated, not to enforce a patent (such as an express permission to practice a patent or covenant not to sue for patent infringement). To "grant" such a patent license to a party means to make such an agreement or commitment not to enforce a patent against the party.

If you convey a covered work, knowingly relying on a patent license, and the Corresponding Source of the work is not available for anyone to copy, free of charge and under the terms of this License, through a publicly available network server or other readily accessible means, then you must either (1) cause the Corresponding Source to be so available, or (2) arrange to deprive yourself of the benefit of the patent license for this particular work, or (3) arrange, in a manner consistent with the requirements of this License, to extend the patent license to downstream recipients. "Knowingly relying" means you have actual knowledge that, but for the patent license, your conveying the covered work in a country, or your recipient's use of the covered work in a country, would infringe one or more identifiable patents in that country that you have reason to believe are valid.

If, pursuant to or in connection with a single transaction or arrangement, you convey, or propagate by procuring conveyance of, a covered work, and grant a patent license to some of the parties receiving the covered work authorizing them to use, propagate, modify or convey a specific copy of the covered work, then the patent license you grant is automatically extended to all recipients of the covered work and works based on it.

A patent license is "discriminatory" if it does not include within the scope of its coverage, prohibits the exercise of, or is conditioned on the non-exercise of one or more of the rights that are specifically granted under this License. You may not convey a covered work if you are a party to an arrangement with a third party that is in the business of distributing software, under which you make payment to the third party based on the extent of your activity of conveying the work, and under which the third party grants, to any of the parties who would receive the covered work from you, a discriminatory patent license (a) in connection with copies of the covered work conveyed by you (or copies made from those copies), or (b) primarily for and in connection with specific products or compilations that contain the covered work, unless you entered into that arrangement, or that patent license was granted, prior to 28 March 2007.

Nothing in this License shall be construed as excluding or limiting any implied license or other defenses to infringement that may otherwise be available to you under applicable patent law.

## 12. No Surrender of Others' Freedom.

If conditions are imposed on you (whether by court order, agreement or otherwise) that contradict the conditions of this License, they do not excuse you from the conditions of this License. If you cannot convey a covered work so as to satisfy simultaneously your obligations under this License and any other pertinent obligations, then as a consequence you may not convey it at all. For example, if you agree to terms that obligate you to collect a royalty for further conveying from those to whom you convey the Program, the only way you could satisfy both those terms and this License would be to refrain entirely from conveying the Program.

## 13. Use with the GNU Affero General Public License.

Notwithstanding any other provision of this License, you have permission to link or combine any covered work with a work licensed under version 3 of the GNU Affero General Public License into a single combined work, and to convey the resulting work. The terms of this License will continue to apply to the part which is the covered work, but the special requirements of the GNU Affero General Public License, section 13, concerning interaction through a network will apply to the combination as such.

## 14. Revised Versions of this License.

The Free Software Foundation may publish revised and/or new versions of the GNU General Public License from time to time. Such new versions will be similar in spirit to the present version, but may differ in detail to address new problems or concerns.

Each version is given a distinguishing version number. If the Program specifies that a certain numbered version of the GNU General Public License "or any later version" applies to it, you have the option of following the terms and conditions either of that numbered version or of any later version published by the Free Software Foundation. If the Program does not specify a version number of the GNU General Public License, you may choose any version ever published by the Free Software Foundation.

If the Program specifies that a proxy can decide which future versions of the GNU General Public License can be used, that proxy's public statement of acceptance of a version permanently authorizes you to choose that version for the Program.

Later license versions may give you additional or different permissions. However, no additional obligations are imposed on any author or copyright holder as a result of your choosing to follow a later version.

## 15. Disclaimer of Warranty.

THERE IS NO WARRANTY FOR THE PROGRAM, TO THE EXTENT PERMITTED BY APPLICABLE LAW. EXCEPT WHEN OTHERWISE STATED IN WRITING THE COPYRIGHT HOLDERS AND/OR OTHER PARTIES PROVIDE THE PROGRAM "AS IS" WITHOUT WARRANTY OF ANY KIND, EITHER EXPRESSED OR IMPLIED, INCLUDING, BUT NOT LIMITED TO, THE IMPLIED WARRANTIES OF MERCHANTABILITY AND FITNESS FOR A PARTICULAR PURPOSE. THE ENTIRE RISK AS TO THE QUALITY AND PERFORMANCE OF THE PROGRAM IS WITH YOU. SHOULD THE PROGRAM PROVE DEFECTIVE, YOU ASSUME THE COST OF ALL NECESSARY SERVICING, REPAIR OR CORRECTION.

## 16. Limitation of Liability.

IN NO EVENT UNLESS REQUIRED BY APPLICABLE LAW OR AGREED TO IN WRITING WILL ANY COPYRIGHT HOLDER, OR ANY OTHER PARTY WHO MODIFIES AND/OR CONVEYS THE PROGRAM AS PERMITTED ABOVE, BE LIABLE TO YOU FOR DAMAGES, INCLUDING ANY GENERAL, SPECIAL, INCIDENTAL OR CONSEQUENTIAL DAMAGES ARISING OUT OF THE USE OR INABILITY TO USE THE PROGRAM (INCLUDING BUT NOT LIMITED TO LOSS OF DATA OR DATA BEING RENDERED INACCURATE OR LOSSES SUSTAINED BY YOU OR THIRD PARTIES OR A FAILURE OF THE PROGRAM TO OPERATE WITH ANY OTHER PROGRAMS), EVEN IF SUCH HOLDER OR OTHER PARTY HAS BEEN ADVISED OF THE POSSIBILITY OF SUCH DAMAGES.

## 17. Interpretation of Sections 15 and 16.

If the disclaimer of warranty and limitation of liability provided above cannot be given local legal effect according to their terms, reviewing courts shall apply local law that most closely approximates an absolute waiver of all civil liability in connection with the Program, unless a warranty or assumption of liability accompanies a copy of the Program in return for a fee.

## END OF TERMS AND CONDITIONS

### How to Apply These Terms to Your New Programs

If you develop a new program, and you want it to be of the greatest possible use to the public, the best way to achieve this is to make it free software which everyone can redistribute and change under these terms.

To do so, attach the following notices to the program. It is safest to attach them to the start of each source file to most effectively state the exclusion of warranty; and each file should have at least the "copyright" line and a pointer to where the full notice is found.

<one line to give the program's name and a brief idea of what it does.>

Copyright (C) <year> <name of author>

This program is free software: you can redistribute it and/or modify it under the terms of the GNU General Public License as published by the Free Software Foundation, either version 3 of the License, or (at your option) any later version.

This program is distributed in the hope that it will be useful, but WITHOUT ANY WARRANTY; without even the implied warranty of MERCHANTABILITY or FITNESS FOR A PARTICULAR PURPOSE. See the GNU General Public License for more details.

You should have received a copy of the GNU General Public License along with this program. If not, see <<http://www.gnu.org/licenses/>>.

Also add information on how to contact you by electronic and paper mail.

If the program does terminal interaction, make it output a short notice like this when it starts in an interactive mode:

<program> Copyright (C) <year> <name of author>

This program comes with ABSOLUTELY NO WARRANTY; for details type `show w'.

This is free software, and you are welcome to redistribute it under certain

conditions; type `show c' for details.

The hypothetical commands `show w' and `show c' should show the appropriate parts of the General Public License. Of course, your program's commands might be different; for a GUI interface, you would use an "about box".

You should also get your employer (if you work as a programmer) or school, if any, to sign a "copyright disclaimer" for the program, if necessary. For more information on this, and how to apply and follow the GNU GPL, see <<http://www.gnu.org/licenses/>>.

The GNU General Public License does not permit incorporating your program into proprietary programs. If your program is a subroutine library, you may consider it more useful to permit linking proprietary applications with the library. If this is what you want to do, use the GNU Lesser General Public License instead of this License. But first, please read <<http://www.gnu.org/philosophy/why-not-lgpl.html>>.

## □ 7zip 9.20

This package was debianized by Mohammed Adnène Trojette <[adn+deb@diwi.org](mailto:adn+deb@diwi.org)> on Sun, 12 Dec 2004 14:28:27 +0200.

The current Debian maintainer is Mohammed Adnène Trojette <[adn+deb@diwi.org](mailto:adn+deb@diwi.org)>.

It was downloaded from <<http://p7zip.sourceforge.net/>>.

Files in CPP/7zip/Crypto/AES files are released the termes of the GNU LGPL and AES code license (a BSD-like license, see below).

7zip is Copyright (C) 1999-2006 Igor Pavlov.  
p7zip is ported from 7zip by my space <[myspace@users.sourceforge.net](mailto:myspace@users.sourceforge.net)>

LGPL

----

This program is free software; you can redistribute it and/or modify it under the terms of the GNU Lesser General Public License as published by the Free Software Foundation; either version 2.1 of the License, or (at your option) any later version.

This program is distributed in the hope that it will be useful, but WITHOUT ANY WARRANTY; without even the implied warranty of MERCHANTABILITY or FITNESS FOR A PARTICULAR PURPOSE. See the GNU Lesser General Public License for more details.

You should have received a copy of the GNU Lesser General Public License along with this program; if not, write to the Free Software Foundation, Inc., 51 Franklin St, Fifth Floor, Boston, MA 02110-1301 USA

On Debian systems, the complete text of the GNU Lesser General Public License, can be found in /usr/share/common-licenses/LGPL.

AES License

-----

Copyright (c) 2001, Dr Brian Gladman

## LICENSE TERMS

The free distribution and use of this software in both source and binary form is allowed (with or without changes) provided that:

1. distributions of this source code include the above copyright notice, this list of conditions and the following disclaimer;
2. distributions in binary form include the above copyright notice, this list of conditions and the following disclaimer in the documentation and/or other associated materials;
3. the copyright holder's name is not used to endorse products built using this software without specific written permission.

## DISCLAIMER

This software is provided 'as is' with no explicit or implied warranties in respect of its properties, including, but not limited to, correctness and fitness for purpose.

## Packaging

-----

The current Debian packaging is (C) 2004-2006, Mohammed Adnène Trojette <adn+deb@diwi.org> and is licensed under the GPL, see /usr/share/common-licenses/GPL.

## ❑ Berkeley DB 5.3.21

The Sleepycat License

Copyright (c) 1990-1999 Sleepycat Software. All rights reserved.

Redistribution and use in source and binary forms, with or without modification, are permitted provided that the following conditions are met:

- Redistributions of source code must retain the above copyright notice, this list of conditions and the following disclaimer.
- Redistributions in binary form must reproduce the above copyright notice, this list of conditions and the following disclaimer in the documentation and/or other materials provided with the distribution.
- Redistributions in any form must be accompanied by information on how to obtain complete source code for the DB software and any accompanying software that uses the DB software. The source code must either be included in the distribution or be available for no more than the cost of distribution plus a nominal fee, and must be freely redistributable under reasonable conditions. For an executable file, complete source code means the source code for all modules it contains. It does not include source code for modules or files that typically accompany the major components of the operating system on which the executable file runs.

THIS SOFTWARE IS PROVIDED BY SLEEPYCAT SOFTWARE "AS IS" AND ANY EXPRESS OR IMPLIED WARRANTIES, INCLUDING, BUT NOT LIMITED TO, THE IMPLIED WARRANTIES OF MERCHANTABILITY, FITNESS FOR A PARTICULAR PURPOSE, OR NON-INFRINGEMENT, ARE DISCLAIMED. IN NO EVENT SHALL SLEEPYCAT SOFTWARE BE LIABLE FOR ANY DIRECT, INDIRECT, INCIDENTAL, SPECIAL, EXEMPLARY, OR CONSEQUENTIAL DAMAGES (INCLUDING, BUT NOT LIMITED TO, PROCUREMENT OF SUBSTITUTE GOODS OR SERVICES; LOSS OF USE, DATA, OR PROFITS; OR BUSINESS INTERRUPTION) HOWEVER CAUSED



AND ON ANY THEORY OF LIABILITY, WHETHER IN CONTRACT, STRICT LIABILITY, OR TORT (INCLUDING NEGLIGENCE OR OTHERWISE) ARISING IN ANY WAY OUT OF THE USE OF THIS SOFTWARE, EVEN IF ADVISED OF THE POSSIBILITY OF SUCH DAMAGE.

Copyright (c) 1990, 1993, 1994, 1995 The Regents of the University of California. All rights reserved.

Redistribution and use in source and binary forms, with or without modification, are permitted provided that the following conditions are met:

- Redistributions of source code must retain the above copyright notice, this list of conditions and the following disclaimer.
- Redistributions in binary form must reproduce the above copyright notice, this list of conditions and the following disclaimer in the documentation and/or other materials provided with the distribution.
- Neither the name of the University nor the names of its contributors may be used to endorse or promote products derived from this software without specific prior written permission.

THIS SOFTWARE IS PROVIDED BY THE REGENTS AND CONTRIBUTORS "AS IS" AND ANY EXPRESS OR IMPLIED WARRANTIES, INCLUDING, BUT NOT LIMITED TO, THE IMPLIED WARRANTIES OF MERCHANTABILITY AND FITNESS FOR A PARTICULAR PURPOSE ARE DISCLAIMED. IN NO EVENT SHALL THE REGENTS OR CONTRIBUTORS BE LIABLE FOR ANY DIRECT, INDIRECT, INCIDENTAL, SPECIAL, EXEMPLARY, OR CONSEQUENTIAL DAMAGES (INCLUDING, BUT NOT LIMITED TO, PROCUREMENT OF SUBSTITUTE GOODS OR SERVICES; LOSS OF USE, DATA, OR PROFITS; OR BUSINESS INTERRUPTION) HOWEVER CAUSED AND ON ANY THEORY OF LIABILITY, WHETHER IN CONTRACT, STRICT LIABILITY, OR TORT (INCLUDING NEGLIGENCE OR OTHERWISE) ARISING IN ANY WAY OUT OF THE USE OF THIS SOFTWARE, EVEN IF ADVISED OF THE POSSIBILITY OF SUCH DAMAGE.

Copyright (c) 1995, 1996 The President and Fellows of Harvard University. All rights reserved.

Redistribution and use in source and binary forms, with or without modification, are permitted provided that the following conditions are met:

- Redistributions of source code must retain the above copyright notice, this list of conditions and the following disclaimer.
- Redistributions in binary form must reproduce the above copyright notice, this list of conditions and the following disclaimer in the documentation and/or other materials provided with the distribution.
- Neither the name of the University nor the names of its contributors may be used to endorse or promote products derived from this software without specific prior written permission.

THIS SOFTWARE IS PROVIDED BY HARVARD AND ITS CONTRIBUTORS "AS IS" AND ANY EXPRESS OR IMPLIED WARRANTIES, INCLUDING, BUT NOT LIMITED TO, THE IMPLIED WARRANTIES OF MERCHANTABILITY AND FITNESS FOR A PARTICULAR PURPOSE ARE DISCLAIMED. IN NO EVENT SHALL HARVARD OR ITS CONTRIBUTORS BE LIABLE FOR ANY DIRECT, INDIRECT, INCIDENTAL, SPECIAL, EXEMPLARY, OR CONSEQUENTIAL DAMAGES (INCLUDING, BUT NOT LIMITED TO, PROCUREMENT OF SUBSTITUTE GOODS OR SERVICES; LOSS OF USE, DATA, OR PROFITS; OR BUSINESS INTERRUPTION) HOWEVER CAUSED



AND ON ANY THEORY OF LIABILITY, WHETHER IN CONTRACT, STRICT LIABILITY, OR TORT (INCLUDING NEGLIGENCE OR OTHERWISE) ARISING IN ANY WAY OUT OF THE USE OF THIS SOFTWARE, EVEN IF ADVISED OF THE POSSIBILITY OF SUCH DAMAGE.

## □ ZIP UTILS

This is version 2009-Jan-02 of the Info-ZIP license. The definitive version of this document should be available at <ftp://ftp.info-zip.org/pub/infozip/license.html> indefinitely and a copy at <http://www.info-zip.org/pub/infozip/license.html>.

Copyright (c) 1990-2009 Info-ZIP. All rights reserved.

For the purposes of this copyright and license, "Info-ZIP" is defined as the following set of individuals:

Mark Adler, John Bush, Karl Davis, Harald Denker, Jean-Michel Dubois, Jean-loup Gailly, Hunter Goatley, Ed Gordon, Ian Gorman, Chris Herborth, Dirk Haase, Greg Hartwig, Robert Heath, Jonathan Hudson, Paul Kienitz, David Kirschbaum, Johnny Lee, Onno van der Linden, Igor Mandrichenko, Steve P. Miller, Sergio Monesi, Keith Owens, George Petrov, Greg Roelofs, Kai Uwe Rommel, Steve Salisbury, Dave Smith, Steven M. Schweda, Christian Spieler, Cosmin Truta, Antoine Verheijen, Paul von Behren, Rich Wales, Mike White.

This software is provided "as is," without warranty of any kind, express or implied. In no event shall Info-ZIP or its contributors be held liable for any direct, indirect, incidental, special or consequential damages arising out of the use of or inability to use this software.

Permission is granted to anyone to use this software for any purpose, including commercial applications, and to alter it and redistribute it freely, subject to the above disclaimer and the following restrictions:

- Redistributions of source code (in whole or in part) must retain the above copyright notice, definition, disclaimer, and this list of conditions.
- Redistributions in binary form (compiled executables and libraries) must reproduce the above copyright notice, definition, disclaimer, and this list of conditions in documentation and/or other materials provided with the distribution. Additional documentation is not needed for executables where a command line license option provides these and a note regarding this option is in the executable's startup banner. The sole exception to this condition is redistribution of a standard UnZipSFX binary (including SFXWiz) as part of a self-extracting archive; that is permitted without inclusion of this license, as long as the normal SFX banner has not been removed from the binary or disabled.
- Altered versions—including, but not limited to, ports to new operating systems, existing ports with new graphical interfaces, versions with modified or added functionality, and dynamic, shared, or static library versions not from Info-ZIP—must be plainly marked as such and must not be misrepresented as being the original source or, if binaries, compiled from the original source. Such altered versions also must not be misrepresented as being Info-ZIP releases—including, but not limited to, labeling of the altered versions with the names "Info-ZIP" (or any variation thereof, including, but not limited to, different capitalizations), "Pocket UnZip," "WiZ" or "MacZip" without the explicit permission of Info-ZIP. Such altered versions are further prohibited from misrepresentative use of the Zip-Bugs or Info-ZIP e-mail addresses or the Info-ZIP URL(s), such as to imply Info-ZIP will provide support for the altered versions.

· Info-ZIP retains the right to use the names "Info-ZIP," "Zip," "UnZip," "UnZipSFX," "WiZ," "Pocket UnZip," "Pocket Zip," and "MacZip" for its own source and binary releases.

-----

/\* zlib.h -- interface of the 'zlib' general purpose compression library version 1.2.11, January 15th, 2017

Copyright (C) 1995-2017 Jean-loup Gailly and Mark Adler

This software is provided 'as-is', without any express or implied warranty. In no event will the authors be held liable for any damages arising from the use of this software.

Permission is granted to anyone to use this software for any purpose, including commercial applications, and to alter it and redistribute it freely, subject to the following restrictions:

1. The origin of this software must not be misrepresented; you must not claim that you wrote the original software. If you use this software in a product, an acknowledgment in the product documentation would be appreciated but is not required.
2. Altered source versions must be plainly marked as such, and must not be misrepresented as being the original software.
3. This notice may not be removed or altered from any source distribution.

Jean-loup Gailly  
jloup@gzip.org

Mark Adler  
madler@alumni.caltech.edu

\*/

## □ Prototype JS 1.7

Prototype is Copyright © 2005-2007 Sam Stephenson. It is freely distributable under the terms of an MIT-style license.

Copyright (c) 2005-2010 Sam Stephenson

Permission is hereby granted, free of charge, to any person obtaining a copy of this software and associated documentation files (the "Software"), to deal in the Software without restriction, including without limitation the rights to use, copy, modify, merge, publish, distribute, sublicense, and/or sell copies of the Software, and to permit persons to whom the Software is furnished to do so, subject to the following conditions:

THE SOFTWARE IS PROVIDED "AS IS", WITHOUT WARRANTY OF ANY KIND, EXPRESS OR IMPLIED, INCLUDING BUT NOT LIMITED TO THE WARRANTIES OF MERCHANTABILITY, FITNESS FOR A PARTICULAR PURPOSE AND NONINFRINGEMENT. IN NO EVENT SHALL THE AUTHORS OR COPYRIGHT HOLDERS BE LIABLE FOR ANY CLAIM, DAMAGES OR OTHER LIABILITY, WHETHER IN AN ACTION OF CONTRACT, TORT OR OTHERWISE, ARISING FROM, OUT OF OR IN CONNECTION WITH THE SOFTWARE OR THE USE OR OTHER DEALINGS IN THE SOFTWARE.

The Prototype documentation is Copyright © 2007 The Prototype Core Team. It is released under the Creative Commons Attribution-ShareAlike 3.0 license.

(空白ページ)

---

当社ホームページでは、各種商品の最新の情報などを提供しています。  
本商品を最適にご利用いただくために、定期的にごらんいただくことをお勧めします。

当社ホームページ: [http://flets-w.com/solution/kiki\\_info/](http://flets-w.com/solution/kiki_info/)

---

使い方等でご不明の点がございましたら、NTT通信機器お取扱相談センタへお気軽にご相談ください。

## NTT通信機器お取扱相談センタ

お問い合わせ先:  0120-248995

※PHS・携帯電話からも利用可能です。

受付時間: 9:00～17:00

※年末年始: 12月29日～1月3日は休業とさせていただきます。

## 故障に関するお問い合わせ

故障した場合のお問い合わせは局番なしの113番へご連絡ください。(24時間 年中無休)

※ 携帯電話・PHSからは「0120-444-113」にてお受けしています。

※ 故障修理等の対応時間は9:00～17:00となります。

(17:00～翌日9:00までは録音にて受付しており順次ご対応いたします。)

電話番号はお間違えにならないように、ご注意願います。

---

© 2018 NTTWEST

